

FIRESTOPPING TEST WITNESS REPORT

for

NORDIC STRUCTURES

Prepared for

Nordic Structures
1100 av des Canadiens-de-Montreal
Montreal, QC
H3B 2S2

September 26, 2016

GHL File NEW-4830.01



TABLE OF CONTENTS

	Page
1.0 ACKNOWLEDGEMENT	1
2.0 PURPOSE	1
3.0 OBSERVATIONS	1
3.1 Objectives of Testing.....	1
3.2 Insulation Note	1
3.3 Hilti-Drop-in-Device	2
3.4 Sample Selection	2
3.5 H-Rating Hose Stream Test.....	2
3.6 T-Rating Temperature.....	2
3.7 Results – Metallic Penetrations.....	3
3.8 Observations – Metallic Penetrations	4
3.9 Results – Plastic Penetrations	5
3.10 Observations – Plastic Pipe	5
3.11 Application to Wall Assemblies	7
3.12 General Observations Applicable to Engineering Judgments	7
3.13 Observations Regarding Joints.....	8
3.14 Use of Recommendations for US Applications	9
4.0 CONCLUSION	10

APPENDICES

Appendix A	Intertek Report Number 102389123COQ-006
Appendix B	Nordic X-Lam Product Information
Appendix C	Fire Stops and Sealing Joints in Cross-laminated Timber Construction, May 12, 2014, FPIinnovations
Appendix D	Engineering Modifications to Fire Tested and Listed Assemblies – <i>Innovation</i> January/February 2007 APEGBC
Appendix E	Fire Performance of Cross-Laminated Timber Panel-to-Panel Joints, March 31, 2015, FPIinnovations



1.0 ACKNOWLEDGEMENT

This report was produced for the Canadian Wood Council and Nordic Structures with funding support from Natural Resources Canada.

2.0 PURPOSE

GHL CONSULTANTS LTD (GHL) has witnessed the testing of firestop systems installed within CLT assemblies to CAN/ULC-S115 2011 at Intertek Laboratories in Coquitlam on February 15 to 17, 2016.

This report is supplemental to the attached test report in *Appendix A* produced by Intertek and serves four purposes:

1. To confirm that we witnessed the tests noted.
2. To provide our observations in addition to those recorded by Intertek.
3. To identify some reliable and sound interpolations of the data to support firestop judgments.
4. To identify, based on these tests and other tests of CLT assemblies (also included as appendices) witnessed by our office, some clear concepts that assist in application of the data to joint configurations.

The testing performed by Intertek on February 15 to 17 consisted of horizontal through penetrations within CLT floor assemblies being exposed to the standardized time temperature curve of CAN/ULC S101. The through penetrations tested were of cast iron, schedule 40, copper and plastic pipes, bundled cables and a drop in Hilti firestop device.

3.0 OBSERVATIONS

We have reviewed and are in general agreement with the Intertek report number 102389123COQ-006, dated March 30, 2016, copy attached in *Appendix A*. We note the following:

3.1 Objectives of Testing

Concerns have been raised that there may be specific considerations or methods required for firestopping of penetrations and joints in CLT. The objective of the testing was to confirm that CLT can be appropriately firestopped and to provide preliminary tested designs for use on early projects until such a time as the firestop industry develops a repertoire of standard listed designs for CLT, as is currently available for traditional materials such as concrete and steel floor and wall assemblies.

3.2 Insulation Note

It is noted that both preformed and manually packed mineral wool was used in order to obtain the 1in of insulation within the annular space of the penetrations. Preformed and manually packed mineral wool are considered to provide equivalent performance. It is noted that preformed insulation ensures a minimum thickness will be provided in comparison to the packed mineral wool, which could be manually installed at a thickness less than 1in; thus the preformed insulation simplifies field inspection and review processes. With the exception of the Hilti device, mineral wool was installed around the penetrations such that the entire depth of the annular space was filled, leaving only the required depth of caulking in the annular space without mineral wool.



3.3 Hilti-Drop-in-Device

A special note is warranted on the Hilti 'Drop-in-Device' CFS-DID 6"C. This device is essentially a steel sleeve with pre-installed intumescent strips, which has been tested with a wide range of penetrating items. This device was tested blanked off with mineral wool to support engineering judgments. Essentially, it is our opinion that by demonstrating the Drop-in-Device, which has an approved listing for concrete floor assemblies, can be appropriately installed in a CLT panel and achieve the same rating as when tested in a concrete assembly, that other firestop assemblies listed for concrete are also likely to achieve the same rating when appropriately installed and tested in a CLT panel.

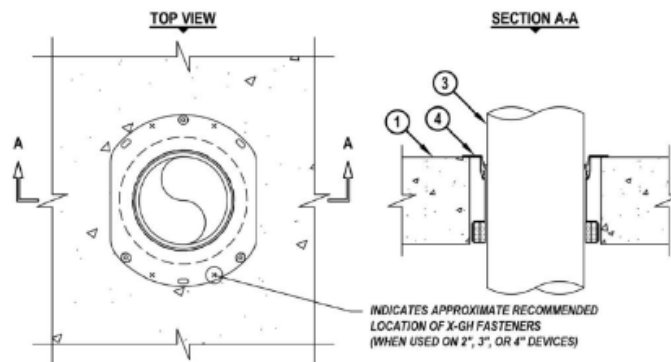

3.4 Sample Selection

Intertek's test report is correct in stating the CLT was not randomly selected by Intertek. We can confirm, based on our many years of work with CLT, the sample was representative of generic CLT produced in accordance with the ANSI/APA PRG 320 Standard. Product documentation from Nordic Structures is attached in *Appendix B*. We note that CLT, manufactured per the PRG 320 standard is now identified as a generic material in CSA O86-14 Engineering Design in Wood, as referenced by the National Building Code of Canada 2015, although the specific design data is not expected until CSA-086-16 is published.

Similarly, we can confirm that the penetrating items were representative of typical pipes and wiring expected to be used in these buildings. That is, the penetrating items were randomly selected by the installation contractor, with no input by Nordic Structures or GHIL Consultants Ltd.

3.5 H-Rating Hose Stream Test

The National Building Code of Canada prescribes firestopping with an 'F' rating for locations where CLT is penetrated. The Hose Stream Test is only required for an FH or FTH rating. Currently neither FH nor FTH ratings are prescribed by the National Building Code of Canada 2010 and 2015 editions.

3.6 T-Rating Temperature

The FT rating is only prescribed for limited locations and not required for locations where CLT is currently being used.



3.7 Results – Metallic Penetrations

Test 1, consisted of 78mm CLT and metallic penetrations including Data Cables and Hilti Drop-in-Device, provided a 1h F rating for all penetrations as shown in the Intertek Table ‘Test Assembly No 1, reproduced below:

Test Assembly No. 1				ULC S115-11		
Item (size & type)	Opening (size)	Annular Space (min/max)	Firestop System	F	T	FT
Data Cable Bunch 1 – ½in. (38.1mm) Dia.	3 – ½in. (89mm)	1in. (25.4mm)	Mineral wool was installed in the 1in. annular space around the data cables to a total depth of approximately 2 – 5/64in. (52.8mm). The remaining 1in. annular space (25.4mm) from the top of the mineral wool to the top of the floor assembly was filled with Hilti FS-One Max caulking.	1 hr	½ hr	½ hr
Copper Pipe 2in. (50.8mm) Dia.	4 – 3/8in. (111mm)	1in. (25.4mm)	Pipe wrap was installed around the copper pipe to a total depth of approximately 2 – 5/64in. (52.8mm). The remaining 1in. annular space starting at the top of the mineral wool to the top of the floor assembly was filled with Hilti FS-One Max caulking.	1 hr	-	-
Schedule 40 2 – ½in. (63.5mm) Dia.	4 – 59/64in. (125mm)	1in. (25.4mm)	Pipe wrap was installed around the schedule 40 pipe to a total depth of approximately 2 – 5/64in. (52.8mm). The remaining 1in. annular space starting at the top of the pipe wrap to the top of the floor assembly was filled with Hilti FS-One Max caulking.	1 hr	-	-
Cast Iron 6in. (152.4mm) Dia.	8 – 11/32in. (212mm)	1in. (25.4mm)	Mineral wool was installed in the 1in. annular space around the cast iron pipe to a total depth of approximately 2 – 5/64in. (52.8mm). The remaining 1in. annular space starting at the top of the pipe wrap to the top of the floor assembly was filled with Hilti FS-One Max caulking.	1 hr	-	-
Hilti 6in. (152.4mm) Drop-In Device System No.: F- B-2049	9 – 1/64in. (229mm)	1in. (25.4mm)	Mineral wool was installed in the 1 – ¼in. annular space around the drop-in device to a total depth of approximately 1 – 7/64in. (28mm) and the remaining 1in. annular space from the top of the mineral wool to the top edge of the 9 – 1/64in. hole in the CLT was filled with Hilti FS-One Max caulking.	1 hr	¾ hr	¾ hr

Test 3, consisted of 131mm CLT and metallic penetrations including Data Cables and Hilti Drop-in-Device, provided a 2h F rating for all penetrations as shown in the Intertek Table ‘Test Assembly No 3, reproduced below:



Test Assembly No. 3

Item (size & type)	Opening (size)	Annular Space (min/max)	Firestop System	ULC S115-11		
				F	T	FT
Copper Pipe 2in. (50.8mm) Dia.	4 – 3/8in. (111mm)	1in. (25.4mm)	Pipe wrap was installed around the copper pipe to a total depth of approximately 4 – 5/32 in. (105.6mm). The remaining 1in. annular space starting at the top of the mineral wool to the top of the floor assembly was filled with Hilti FS-One Max caulking.	2 hr	-	-
Data Cable Bunch 1 – 1/2in. (38.1mm) Dia.	3 – 1/2in. (89mm)	1in. (25.4mm)	Mineral wool was installed in the 1in. annular space around the data cables to a total depth of approximately 4 – 5/32 in. (105.6mm). The remaining 1in. annular space (25.4mm) from the top of the mineral wool to the top of the floor assembly was filled with Hilti FS-One Max caulking.	2 hr	1 1/2 hr	1 1/2 hr
Schedule 40 2 – 1/2in. (63.5mm) Dia.	4 – 59/64in. (125mm)	1in. (25.4mm)	Pipe wrap was installed around the schedule 40 pipe to a total depth of approximately 4 – 5/32 in. (105.6mm). The remaining 1in. annular space starting at the top of the pipe wrap to the top of the floor assembly was filled with Hilti FS-One Max caulking.	2 hr	1/2 hr	1/2 hr
Cast Iron 6in. (152.4mm) Dia.	8 – 11/32in. (212mm)	1in. (25.4mm)	Mineral wool was installed in the 1in. annular space around the cast iron pipe to a total depth of approximately 4 – 5/32 in. (105.6mm). The remaining 1in. annular space starting at the top of the pipe wrap to the top of the floor assembly was filled with Hilti FS-One Max caulking.	2 hr	-	-
Hilti 6in. (152.4mm) Drop-In Device System No.: F-B-2049	9 – 1/64in. (229mm)	1in. (25.4mm)	Mineral wool was installed in the 1 – 1/4in. annular space around the drop-in device to a total depth of approximately 1 – 7/64in. (28mm) and the remaining 1in. annular space from the top of the mineral wool to the top edge of the 9 – 1/64in. hole in the CLT was filled with Hilti FS-One Max caulking.	2 hr	1 1/2 hr	1 1/2 hr

3.8 Observations – Metallic Penetrations

It is noted that both tests indicated the firestopping performed as required as long as the panel remained intact; that is, the panel failed structurally from the weight of the metallic penetrations at 72min for Test 1, leading to deformation and failure of the firestopping. This is consistent with the expected 1h fire resistance rating for a 78mm panel. The 131mm panel did not fail, with the test terminated at 2h.

Note that the CLT handbook provided by FP Innovations provides methodology for calculating fire resistance of the panels and actual fire resistance will vary depending on loading conditions.



Similarly, for the 131mm panel used for Test 3, which is expected to have better than a 2h fire resistance rating, all penetrations remained intact for the entire 120min duration of the test. The test was not extended beyond 2h.

3.9 Results – Plastic Penetrations

Test 2, consisted of 131mm CLT plastic penetrations. In contrast to the metallic penetrations, no successful results were obtained from the plastic pipe penetration test as the intumescent was unable to close the pipes and maintain the prescribed 50Pa pressure.

Test Assembly No. 2

Item (size & type)	Opening (size)	Annular Space (min/max)	Firestop System	ULC S115-11		
				*F	*T	*FT
PVC-IPEX Aqurise Pipe 2in. (50.8mm) Dia.	4 – 3/8in. (111mm)	1in. (25.4mm)	Mineral wool was installed around the pipe to a total depth of approximately 4 – 5/32in. (105.6mm). The remaining 1in. annular space starting at the top of the mineral wool to the top of the floor assembly was filled with Hilti FS-One Max caulking.	-	-	-
XFR Pipe 3in. (76.2mm) Dia.	5 – 25/64in. (137mm)	1in. (25.4mm)	Mineral wool was installed around the pipe to a total depth of approximately 4 – 5/32in. (105.6mm). The remaining 1in. annular space starting at the top of the mineral wool to the top of the floor assembly was filled with Hilti FS-One Max caulking.	-	-	-

**Note: No rating has been awarded to the PVC or XFR penetrations.*

3.10 Observations – Plastic Pipe

These results are not unexpected, as it is known that the majority of successfully tested plastic pipe penetrations have intumescent firestop material or a metal collar located on the bottom fire exposed side; however, this is not practical with CLT as the fire side chars away leaving the intumescent material with no structural support. Further testing of plastic pipe penetrations is recommended.

However, as noted above, the Hilti Drop-in-Device provides a method for firestopping plastic pipe. The Hilti device is a steel sleeve, per the cUL listing F-B-2049 has been tested in a 6in concrete slab to incorporate the following, reproduced from the Listing:

cUL SYSTEM NO. F-B-2049
PLASTIC PIPE THROUGH CONCRETE FLOOR ASSEMBLY
 F-RATING = 3-HR.
 FT-RATING = 0-HR. OR 1/2-HR.
 FH-RATING = 3-HR.
 FTH-RATING = 0-HR. OR 1/2-HR.
 L-RATING AT AMBIENT = LESS THAN 1 CFM / SQ FT (SEE NOTE NO. 2 BELOW)
 L-RATING AT 400°F = LESS THAN 1 CFM / SQ FT (SEE NOTE NO. 2 BELOW)
 W-RATING = CLASS I (SEE NOTE NO. 2 BELOW)
 NOTE : TESTED WITH A 50 Pa PRESSURE DIFFERENTIAL



cUL FB2049c.022714



The testing performed demonstrated the Hilti Drop-in-Device, tested per listing F-B-2049, will perform as well in both CLT, when installed as described in the GHIL Consultants Ltd diagram below, as it performs in concrete:

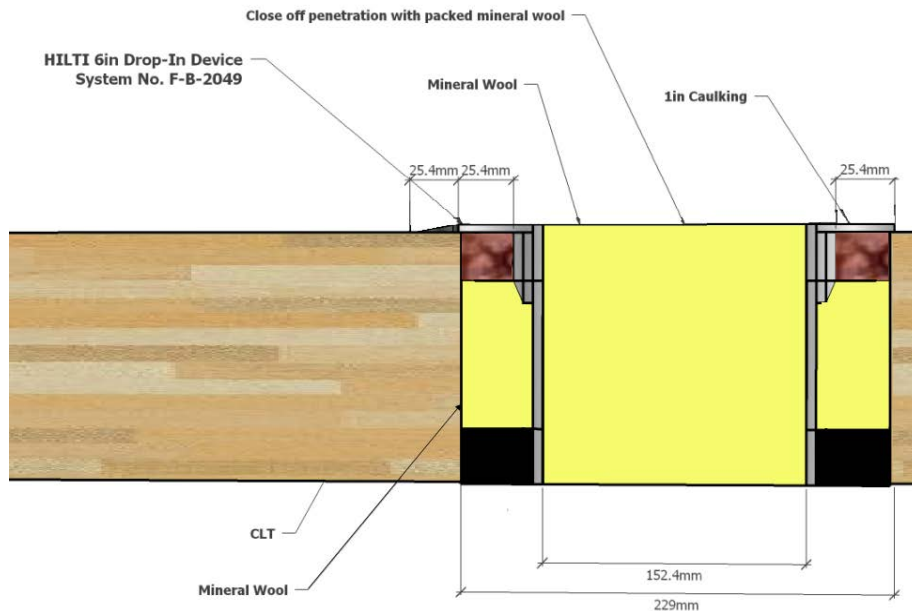

Given that it will perform equally in wood and concrete, it is reasonable to permit any penetrant of the Drop-in-Device identified in cUL listing, as reproduced from the listing below:

3. PENETRATING ITEM TO BE ONE OF THE FOLLOWING :

- A. MAXIMUM 6" NOMINAL DIAMETER PVC PLASTIC PIPE (CELLULAR OR SOLID CORE).
- B. MAXIMUM 6" NOMINAL DIAMETER ABS PLASTIC PIPE (CELLULAR OR SOLID CORE).
- C. MAXIMUM 6" NOMINAL DIAMETER CPVC PLASTIC PIPE.
- D. MAXIMUM 4" NOMINAL DIAMETER FRPP PLASTIC PIPE.
- E. MAXIMUM 4" NOMINAL DIAMETER AQUARISE CPVC PLASTIC PIPE (SDR 11) MANUFACTURED BY IPEX, INC. (CLOSED PIPING SYSTEM ONLY).
- F. MAXIMUM 4" NOMINAL DIAMETER XFR 15/50 PVC PLASTIC PIPE (SOLID CORE).

4. HILTI CFS-DID FIRESTOP DROP-IN DEVICE INSERTED INTO OPENING (SEE TABLE BELOW) AND SECURED TO TOP OF FLOOR WITH THREE HILTI 1/4" (6mm) DIAMETER BY 1-1/4" (32mm) LONG KWIK-CON II+ CONCRETE SCREW ANCHORS, HILTI 1/4" (6mm) DIAMETER BY 1-3/4" (45mm) LONG KWIK BOLT 3 STEEL EXPANSION ANCHORS, OR HILTI 1/4" (6mm) BY 3/4" (19mm) LONG METAL HIT ANCHORS (INSTALLED IN A TRIANGULAR FASHION THROUGH HOLES PROVIDED). IN ADDITION, FOR NOMINAL 2", 3", AND 4" DEVICES, FOUR 11/16" (18mm) LONG HILTI X-GH P18 MX STEEL FASTENERS MAY BE INSTALLED THROUGH THE STEEL FLANGE, TWO ON EACH SIDE.

CORE HOLE OR SLEEVE DIAMETER	PRODUCT DESCRIPTION	NOMINAL PIPE DIAMETER
4"	CFS-DID 2" C	2" (OR SMALLER)+
5"	CFS-DID 3" C	3"
6"	CFS-DID 4" C	4"
9"	CFS-DID 6" C	6"

+ FOR PIPE SMALLER THAN NOMINAL 2" DIAMETER, AN ADAPTER AND HILTI IPS OR CPS TOP SEAL PLUG MUST BE USED IN CONJUNCTION WITH THE CFS-DID 2" C DEVICE.

Therefore, the Hilti device provides a method of firestopping a wide range of plastic pipes and other penetrants through CLT.



3.11 Application to Wall Assemblies

It is noted that a horizontal (floor) assembly was chosen as being more onerous than a wall assembly and, as such, the findings can be equally applied to wall and floor assemblies. Some previous testing of metal pipe penetrations of CLT walls, also witnessed by GHIL Consultants Ltd, occurred in early 2014, documented as Test 6 in the FPInnovations report of May 12, 2014, copy attached in *Appendix C*. While performed for the WIDC project, which required a maximum 45min F rating, the pipe penetration testing was performed for 90min, consistent with the 90min F rating prescribed for 2h fire separations. The installation details for the metal pipes within the FPInnovations report in *Appendix C* were essentially identical to those tested by Intertek as described above; however, a firestop sealant (Hilti CP 606) was provided on both the exposed and unexposed surface in the FPInnovations testing, which is consistent with standard practice for walls, as compared to an intumescent caulking (Hilti FS-One) on only the unexposed side which was used during the Intertek testing.

3.12 General Observations Applicable to Engineering Judgments

The success of these tests of penetrations by mechanical and electrical elements, in conjunction with other tests observed by GHIL Consultants Ltd, enables some basic principles to be established to facilitate engineering judgments as follows:

- Provided the CLT is insulated from the metal by 25mm or more of mineral wool, such that hot metal does not impact the wood, firestopping designs for metal penetrations can reasonably be applied to CLT panels of lesser fire resistance ratings, given that the firestop rating cannot exceed the rating of the CLT panel being penetrated.
- For designs with metal components care is needed, and additional testing to determine the impact of hot metal on char of the adjacent CLT. While testing only addressed the F rating, a T rating can be obtained as the pipe insulation required for a T rating in concrete will be the same as required for T rating in wood.
- The tests incorporated 25mm of insulation within the annular space separating the penetrants from CLT. It is probable that less insulation may be sufficient; however, additional analysis and/or testing will be necessary to reduce the amount of insulation.
- It is noted that mineral wool insulation is available pre-formed in 1in thickness and that there are other firestop systems that incorporate preformed mineral wool insulation that may be applicable. Preformed insulation is noted as having the advantage of enforcing a minimum insulation thickness; thus, simplifying site inspection and field review requirements.
- For metal penetrations, consistent with standard firestopping practice, the designs may be used with smaller pipe provided the annular space and mineral wool insulation is maintained.
- It is probable that a configuration with the Hilti drop in device without mineral wool insulation can be demonstrated to work; however, research is needed as to the relative level of the exterior intumescent material versus the anticipated char front of the CLT.
- For CLT joint gaps less than 6mm, 25mm depth firestop sealant or intumescent caulking is recommended to be installed; as a minimum the firestop must prevent air movement through the gap.
- For CLT joint gaps 6mm to 25mm, mineral wool is recommended to be installed the entire depth of the gap space, leaving only 25mm depth in the gap space on the unexposed side for caulking.



A firestopping rating at least equal to that of the CLT floor assembly's fire resistance rating is expected when this is provided for 6mm to 25mm gaps. It is noted that 3-Ply and 5-Ply CLT panels were tested, it is expected that this applies to larger ply floor assemblies which produce higher resistance ratings; it is recommended to leave only 25mm depth in the annular space on the unexposed side without mineral wool, such that the entire annular space will be filled with mineral wool or caulking, regardless of the CLT panel size.

GHL Consultants Ltd notes that preparation of Engineering Judgments for firestopping is standard practice in the construction industry; however, it is a professional engineering service and should be provided by engineers registered or licenced to practice in the appropriate jurisdiction. Engineering Judgments should carry the seal of the engineer taking responsibility for the design. Guidance on Engineering Judgments can be found in the Association of Professional Engineers of BC (APEGBC) document as attached *Appendix D*.

3.13 Observations Regarding Joints

Firestopping of penetrations requires particular attention due the ability of the penetrations to transfer heat to the assembly, in the case of metallic penetrations, and due to the potential for plastic pipe to melt and create a through hole.

The testing performed for large diameter pipe can be used to demonstrate the effectiveness of similarly firestopped joints. As 1in of mineral wool filling the annular gap between a pipe and a CLT slab, with intumescent caulking at the top, provided a penetration F rating of 2h, it can be reasonably surmised that the same 1in of mineral wool, with caulking, will protect a CLT panel to CLT panel joint of 1in. As there is no heat transfer consideration, a joint thickness of less than 1in would be acceptable, and similarly, a joint thickness of greater thickness would be acceptable provided the joint width did not permit the mineral wool to fall out. Numerous firestop joint configurations permit up to 3in of mineral wool without mechanical fastening.

It is our opinion that the results from the tested firestopped penetrations can be applied to CLT floor joints. An example of applying the firestopping methods used for a tested penetration to butt-jointed CLT panels is shown in the diagrams below.





This approach is confirmed by tests performed for the WIDC project, also described in the FPInnovations report as attached in *Appendix E*. Although these tests did not exceed 90min, given the maximum fire rating of the project was 60min, they did confirm that the approach of firestopping was valid provided the firestop caulking material was located outside the char region. It is noted that the author also witnessed these tests.

The FP report and supporting Intertek report provide a record of tests of floor to wall joint systems of up to 90min with a 12mm gap as illustrated below:

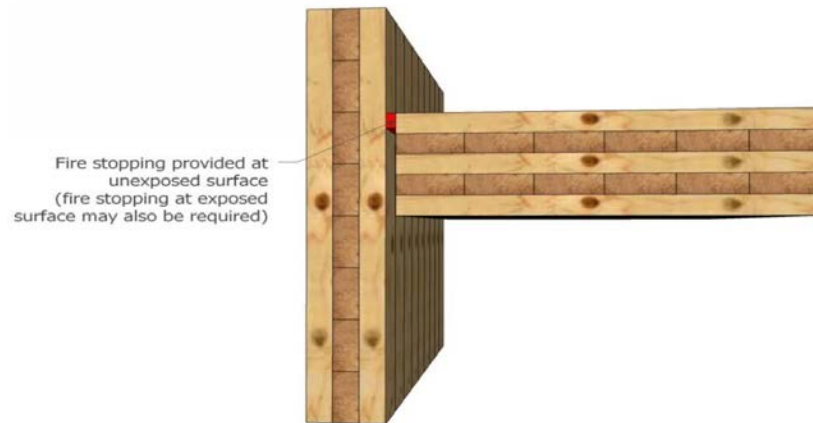

FP Innovations Fire test, courtesy FP Innovations.

Although this assembly was not tested to 2h, based upon our observations of the penetration and joint firestopping tests, we think it is probable that this will achieve a 2h rating.

3.14 Use of Recommendations for US Applications

It is noted that this letter has described firestopping ratings and tests as they relate to the Canadian standard CAN/ULC-S115. The corresponding American test standard for firestopping is ASTM E814; the two standards are almost identical. They both use the same temperature curve, test layout configuration, and thermocouple placement. The primary difference between the standards is that ASTM E814 requires the hose stream test in order to obtain an F rating. It is noted that for Intertek's testing, due to the integrity of the penetrations and CLT floor at end of test, the tested configurations discussed in this letter are expected to pass the hose test. This is backed up by the fact that the tested assemblies exceeded the testing time which was required to obtain the required rating; that is, the test of the 2h rated CLT slab was run for a full 120min with no movement or dislocation of the firestopping material.



4.0 CONCLUSION

We trust this is the information you require. Should you have any questions please contact the undersigned.

Prepared by,
GHL CONSULTANTS LTD



Andrew Harmsworth, M Eng, P Eng, CP, FEC

Enclosures

cc Sean deWinter GHL Consultants Ltd

*** Limitation of Liability ***

This technical report addresses only specific Building Code issues under the GHL/Client agreement for this project and shall in no way be construed as exhaustive or complete. This technical report is issued only to the Authority Having Jurisdiction, the Client, Prime Consultants and Fire Suppression Designer to this project and shall not be relied upon (without prior written authorization from GHL) by any other party.

AH/kl

P:\PRJ\48\4830.01 - Firestopping Nordic, Quebec City\Report\Report (GHL 4830.01).doc

Appendix A

Intertek Report Number
102389123COQ-006

TEST REPORT

Intertek

REPORT NUMBER: 102389123COQ-006

Issue Date: March 30, 2016

EVALUATION CENTER
Intertek Testing Services NA Ltd.
1500 Brigantine Drive
Coquitlam, B.C. V3K 7C1

RENDERED TO

CANADIAN WOOD COUNCIL
99 Rue Bank Street Suite / Bureau 400
Ottawa, ON K1P 6B9
Canada
Phone: (613) 747-5544

PRODUCT EVALUATED: Horizontal Through-Penetration Firestop Systems
through Cross Laminated Timber Panels (CLT)
EVALUATION PROPERTY: Fire Resistance

**Report of Testing Horizontal Through-Penetration Firestop
Systems for compliance with the applicable requirements of the
following criteria: CAN ULC S115-11, *Standard Method of Fire
Tests of Firestop Systems.***



This report is for the exclusive use of Intertek's Client and is provided pursuant to the agreement between Intertek and its Client. Intertek's responsibility and liability are limited to the terms and conditions of the agreement. Intertek assumes no liability to any party, other than to the Client in accordance with the agreement, for any loss, expense or damage occasioned by the use of this report. Only the Client is authorized to permit copying or distribution of this report and then only in its entirety. Any use of the Intertek name or one of its marks for the sale or advertisement of the tested material, product or service must first be approved in writing by Intertek. The observations and test results in this report are relevant only to the sample tested. This report by itself does not imply that the material, product, or service is or has ever been under an Intertek certification program.

1 Table of Contents

	PAGE
1 Table of Contents	2
2 Introduction	3
3 Test Samples	3
3.1. SAMPLE SELECTION	3
3.2. SAMPLE AND ASSEMBLY DESCRIPTION	3
3.2.1 Test Assembly No. 1	3
3.2.2 Test Assembly No. 2	4
3.2.3 Test Assembly No. 3	5
3.3. UNEXPOSED SURFACE TEMPERATURE LOCATIONS	6
3.3.1 Test Assembly No. 1 [3 – 5/64in. (78mm) CLT Panel w/ 5 penetrations]	6
3.3.2 Test Assembly No. 2 [5 – 5/32in. (131mm) CLT Panel w/ 2 penetrations]	7
3.3.3 Test Assembly No. 3 [5 – 5/32in. (131mm) CLT Panel w/ 5 penetrations]	7
4 Testing and Evaluation Methods	9
4.1. THE FIRE TEST	9
4.2. THE HOSE STREAM TEST	9
5 Testing and Evaluation Results	10
5.1. RESULTS AND OBSERVATIONS	10
5.1.1 Observations - Test Assembly No. 1	10
5.1.2 Observations - Test Assembly No. 2	11
5.1.3 Observations - Test Assembly No. 3	12
6 Conclusion	13
APPENDIX A – Construction Details	8 pages
APPENDIX B – Test Data	11 pages
APPENDIX C – Photographs	4 pages
REVISION SUMMARY	

2 Introduction

Intertek Testing Services NA Ltd. (Intertek) has conducted a fire test for Canadian Wood Council, on horizontal through-penetration firestop systems installed in a cross laminated timber floor to evaluate fire resistance ratings. Testing was conducted in accordance with CAN ULC S115-11, *Standard Method of Fire Tests of Firestop Systems*.

The evaluations began on the following:

- February 15, 2016 for Test Assembly No. 1 (3 ply CLT Panel)
- February 16, 2016 for Test Assembly No. 2 (5 ply CLT Panel w/ plastic pipe and overhead pressure box @ -50 pascals)
- February 17, 2016 for Test Assembly No. 3 (5 ply CLT Panel)

Testing was witnessed by Mr. Andrew Harmsworth and Mr. Sean deWinter on 15th and 16th February and on 17th February by Mr. Adam Nadeem, all representing GHL Consultants Ltd.

3 Test Samples

3.1. SAMPLE SELECTION

The penetrating pipes and cables were purchased locally and were not independently selected for testing. The Hilti FS-One Max intumescent caulking, various pipe wraps and mineral wool were all purchased off the shelf from a local distributor and were not independently selected for testing. Installation of the penetrating items through the assembly was carried out by Mr. Jim Greenwood commissioned by Nordic Structures (CLT Manufacturer) at the Intertek's Test Facility in Coquitlam in the presence of Intertek technical qualified personnel.

The CLT Panel was not independently sampled by Intertek and was sent directly to the test facility from Nordic Structures production facility in Chibougamau, Canada.

3.2. SAMPLE AND ASSEMBLY DESCRIPTION

3.2.1. Test Assembly No. 1

The test assembly consisted of a cross laminated timber panel 3 – 5/6 in. (78mm) thick. One layer of 5/8 in. (16mm) thick Type X gypsum board was installed on the top face of the floor panel as detailed in the drawings. The drywall board was only installed as a precautionary measure to avoid failures (if any) through the floor assembly from to ending the test prematurely. A 1 in. (25.4mm) perimeter was maintained between the drywall cutout and the edge of the caulking.

Opening #1 – The penetrating item consisted of a set of plastic sheathed data cables having a bunched up diameter of approximately 1 – ½ in. (38.1mm) and installed within the CLT floor assembly through the center of a 3 – ½ in. (89mm) diameter hole leaving a 1in. (25.4mm) annular space all around. Mineral wool was installed in the 1 in. annular space around the data cables to a total depth of approximately 2 – 5/64 in. (52.8mm). The remaining 1in annular space

(25.4mm) from the top of the mineral wool to the top of the floor assembly was filled with Hilti FS-One Max caulking.

Opening #2 – The penetrating item consisted of a 2 in. (50.8mm) copper pipe installed within the CLT floor assembly through the center of a 4 – 3/8 in. (111mm) diameter hole leaving a 1in. annular space all around. Pipe wrap was installed around the copper pipe to a total depth of approximately 2 – 5/64 in. (52.8mm). The remaining 1in. annular space starting at the top of the mineral wool to the top of the floor assembly was filled with Hilti FS-One Max caulking.

Opening #3 – The penetrating item consisted of a 2 – ½ in. (63.5mm) Schedule 40 pipe installed within the CLT floor assembly through the center of a 4 – 59/64 in. (125mm) diameter hole leaving a 1 in. annular space all around. Pipe wrap was installed around the schedule 40 pipe to a total depth of approximately 2 – 5/64 in. (52.8mm). The remaining 1in. annular space starting at the top of the pipe wrap to the top of the floor assembly was filled with Hilti FS-One Max caulking.

Opening #4 – The penetrating item consisted of a 6 in. (152.4mm) Cast Iron pipe installed within the CLT floor assembly through the center of a 8 – 11/32 in. (212mm) diameter hole leaving a 1in. annular space all around. Mineral wool was installed in the 1in. annular space around the cast iron pipe to a total depth of approximately 2 – 5/64 in. (52.8mm). The remaining 1in. annular space starting at the top of the pipe wrap to the top of the floor assembly was filled with Hilti FS-One Max caulking.

Opening #5 – The penetrating item was a Hilti 6 in. (152.4mm) Drop-In Device System No. F-B-2049 installed within the CLT floor assembly through the center of a 9 – 1/64 in. (229mm) diameter hole leaving an annular space between 1in. and 1 – ¼ in. all around. Mineral wool was installed in the 1 – ¼ in. annular space around the drop-in device to a total depth of approximately 1 – 7/64 in. (28mm) and the remaining 1in. annular space from the top of the mineral wool to the top edge of the 9 – 1/64 in. hole in the CLT was filled with Hilti FS-One Max caulking.

The test assembly was allowed to cure under laboratory maintained conditions of 25°C (±3°C) & 52% R.H. for a duration of more than 21 days.

3.2.2. Test Assembly No. 2

The test assembly consisted of a cross laminated timber panel 5 – 5/32 in. (131mm) thick. One layer of 5/8 in. (16mm) thick Type X gypsum board was installed on the top face of the floor panel as detailed in the drawings. The drywall board was only installed as a precautionary measure to avoid failures (if any) through the floor assembly from to ending the test prematurely. A 1in. perimeter was maintained between the drywall cutout and the edge of the caulking.

Opening #1 – The penetrating item consisted of a 2 in. (50.8mm) PVC-IPEX Aquarise Pipe installed within the CLT floor assembly through the center of a 4 – 3/8 in. (111mm) diameter hole leaving a 1in. annular space all around. Mineral wool was installed around the pipe to a total depth of approximately 4 – 5/32 in. (105.6mm). The remaining 1in. annular space starting at the top of the mineral wool to the top of the floor assembly was filled with Hilti FS-One Max caulking.

Opening #2 – The penetrating item consisted of a 3 in. (76.2mm) XFR Pipe installed within the CLT floor assembly through the center of a 5 – 25/64 in. (137mm) diameter hole leaving a 1in. annular space all around. Mineral wool was installed around the pipe to a total depth of approximately 4 – 5/32 in. (105.6mm). The remaining 1 in. annular space starting at the top of the mineral wool to the top of the floor assembly was filled with Hilti FS-One Max caulking. The test assembly was allowed to cure under laboratory maintained conditions of 25°C (±3°C) & 52% R.H. for a duration of more than 21 days.

3.2.3 Test Assembly No. 3

The test assembly consisted of a cross laminated timber panel 5 – 5/32 in. (131mm) thick. One layer of 5/8 in. (16mm) thick Type X gypsum board was installed on the top face of the floor panel as detailed in the drawings. The drywall board was only installed as a precautionary measure to avoid failures (if any) through the floor assembly from to ending the test prematurely. A 1 in. perimeter was maintained between the drywall cutout and the edge of the caulking.

Opening #1 – The penetrating item consisted of a 2 in. (50.8mm) copper pipe installed within the CLT floor assembly through the center of a 4 – 3/8 in. (111mm) diameter hole leaving a 1in. annular space all around. Pipe wrap was installed around the copper pipe to a total depth of approximately 4 – 5/32 in. (105.6mm). The remaining 1in. annular space starting at the top of the mineral wool to the top of the floor assembly was filled with Hilti FS-One Max caulking.

Opening #2 – The penetrating item consisted of a set of plastic sheathed data cables having a bunched up diameter of approximately 1 – ½ in. (38.1mm) and installed within the CLT floor assembly through the center of a 3 – ½ in. (89mm) diameter hole leaving a 1in. annular space all around. Mineral wool was installed in the 1in. annular space around the data cables to a total depth of approximately 4 – 5/32 in. (105.6mm). The remaining 1in. (25.4mm) annular space from the top of the mineral wool to the top of the floor assembly was filled with Hilti FS-One Max caulking.

Opening #3 – The penetrating item consisted of a 2 – ½ in. (63.5mm) Schedule 40 pipe installed within the CLT floor assembly through the center of a 4 – 59/64 in. (125mm) diameter hole leaving a 1in. annular space all around. Pipe wrap was installed around the schedule 40 pipe to a total depth of approximately 4 – 5/32 in. (105.6mm). The remaining 1in. annular space starting at the top of the pipe wrap to the top of the floor assembly was filled with Hilti FS-One Max caulking.

Opening #4 – The penetrating item consisted of a 6 in. (152.4mm) Cast Iron pipe installed within the CLT floor assembly through the center of a 8 – 11/32 in. (212mm) diameter hole leaving a 1in. annular space all around. Pipe wrap was installed in the 1in. annular space around the cast iron pipe to a total depth of approximately 4 – 5/32 in. (105.6mm). The remaining 1in. annular space starting at the top of the pipe wrap to the top of the floor assembly was filled with Hilti FS-One Max caulking.

Opening #5 – The penetrating item was a Hilti 6 in (152.4mm) Drop-In Device System No. F-B-2049 installed within the CLT floor assembly through the center of a 9 – 1/64 in. (229mm) diameter hole leaving an annular space between 1in. and 1 – ¼ in. (25.4mm – 31.75mm) all around. Mineral wool was installed in the 1 – ¼ in. (31.75mm) annular space around the drop-in

device to a total depth of approximately 1 – 7/64 in. (28mm) and the remaining 1 in. annular space from the top of the mineral wool to the top edge of the 9 – 1/64 in. hole in the CLT was filled with Hilti FS-One Max caulking.

The test assembly was allowed to cure under laboratory maintained conditions of 25°C (±3°C) & 52% R.H. for a duration of more than 21 days.

See Appendix A – Construction Details

3.3. UNEXPOSED SURFACE THERMOCOUPLE LOCATIONS

Surface thermocouples with insulated pads were fastened to the wall, pipes and firestop devices at various locations as required by the test standards to determine eligibility for a temperature (T) rating.

3.3.1. Test Assembly No. 1 [3 – 5/64in. (78mm) CLT Panel w/ 5 penetrations]

THERMOCOUPLE NO.	LOCATION
TC#1a	1in. (25.4mm) away from the data cable (on surface of the caulking).
TC#1b	Caulking-CLT interface.
TC#1c/e *reference standard section	Equidistant from 3 penetrating items @ 3 – 15/16in. (100mm). This Tc is common for data cable, copper pipe & Schedule 40 pipe but is on the surface of the drywall because there is no access to the CLT surface.
TC#1f	Surface of data cable bunch @ 1in. (25.4mm) from the sample surface.
TC#2a	1in. (25.4mm) away from the copper pipe (on surface of the caulking).
TC#2b	Caulking-CLT interface.
TC#2f	Surface of copper pipe @ 1in. (25.4mm) from the sample surface.
TC#3a	1in. (25.4mm) away from the Sch. 40 pipe (on surface of the caulking).
TC#3b	Caulking-CLT interface.
TC#3c/e	Equidistant from 2 penetrating items @ 3 – 15/16in. (100mm). This Tc is common for Sch. 40 & Cast iron pipe and is on the surface of the drywall because there is no access to the CLT surface.
TC#3f	Surface of Sch. 40 @ 1in. (25.4mm) from the sample surface.
TC#4a	1in. (25.4mm) away from the cast iron pipe (on surface of the caulking).
TC#4b	Caulking-CLT interface.
TC#4c/e	Equidistant from 2 penetrating items @ 3 – 15/16in. (100mm). This Tc is common for cast iron pipe & drop in device but is on the surface of the drywall because there is no access to the CLT surface.
TC#4f	Surface of cast iron @ 1in. (25.4mm) from the sample surface.
TC#5a	1in. (25.4mm) away from the edge of the plastic cap of the drop in device (on the surface of the metallic face plate).
TC#5b	Metallic face plate – CLT interface.
TC#5g	Surface of the plastic covering of the drop in device

3.3.2. Test Assembly No. 2 [5 – 5/32in. (131mm) CLT Panel w/ 2 penetrations]

THERMOCOUPLE NO.	LOCATION
TC#1a	1in. (25.4mm) away from the PVC-IPEX Aquarise Pipe (on surface of the caulking).
TC#1b	Caulking-CLT interface.
TC#1c/e	Equidistant from 2 penetrating items @ 3 – 15/16in. (100mm). This Tc is common for both PVC & XFR pipe but is on the surface of the drywall because there is no access to the CLT surface.
TC#1f	Surface of PVC pipe @ 1in. (25.4mm) from the sample surface.
TC#2a	1in. (25.4mm) away from the XFR Pipe (on surface of the caulking).
TC#2b	Caulking-CLT interface.
TC#2f	Surface of XFR pipe @ 1in. (25.4mm) from the sample surface.

3.3.3 Test Assembly No. 3 [5 – 5/32in. (131mm) CLT Panel w/ 5 penetrations]

THERMOCOUPLE NO.	LOCATION
TC#1a	1in. (25.4mm) away from the copper pipe (on surface of the caulking).
TC#1b	Caulking-CLT interface.
TC#1c/e *reference standard section	Equidistant from 3 penetrating items @ 3 – 15/16in. (100mm). This Tc is common for copper pipe, data cable & Schedule 40 pipe but is on the surface of the drywall because there is no access to the CLT surface.
TC#1f	Surface of copper pipe @ 1in. (25.4mm) from the sample surface.
TC#2a	1in. (25.4mm) away from the data cable (on surface of the caulking).
TC#2b	Caulking-CLT interface.
TC#2f	Surface of data cable @ 1in. (25.4mm) from the sample surface.
TC#3a	1in. (25.4mm) away from the Sch. 40 pipe (on surface of the caulking).
TC#3b	Caulking-CLT interface.
TC#3c/e	Equidistant from 2 penetrating items @ 3 – 15/16in. (100mm). This Tc is common for Sch. 40 & Cast iron pipe and is on the surface of the drywall because there is no access to the CLT surface.
TC#3f	Surface of Sch. 40 @ 1in. (25.4mm) from the sample surface.
TC#4a	1in. (25.4mm) away from the cast iron pipe (on surface of the caulking).
TC#4b	Caulking-CLT interface.
TC#4c/e	Equidistant from 2 penetrating items @ 3 – 15/16in. (100mm). This Tc is common for cast iron pipe & drop in device but is on the surface of the drywall because there is no access to the CLT surface.
TC#4f	Surface of cast iron @ 1in. (25.4mm) from the sample surface.
TC#5a	1in. (25.4mm) away from the edge of the plastic cap of the drop in device (on the surface of the metallic face plate).
TC#5b	Metallic face plate – CLT interface.
TC#5g	Surface of the plastic covering of the drop in device

Please refer to the legend and illustration for placement locations of thermocouples:

- A At a point on the surface of the *test specimen*, 25 mm from one of each type of through-penetrating item;
- B At a point on the surface of the *firestop system* material at the periphery of the *test specimen*;
- C At a point on the surface of the *firestop system* material approximately equidistant from two penetrating items and groups of items, and approximately equidistant from the penetrating item or group of penetrating items and the periphery of the *test specimen*;
- D At a point on any frame installed around the perimeter of the opening;
- E At a point on the unexposed surface of the wall or floor *test assembly* at least 100 mm from any opening;
- F On each type of through-penetrating item at a point 25 mm from the unexposed surface of the *firestop system* material. If the through-penetrating item is insulated or coated on the unexposed side, the thermocouple shall be located on the exterior surface of the insulation or coating. If the coating or insulation does not extend the full length of the penetrating item on the unexposed side, an additional thermocouple shall be installed on the penetrating item 25 mm beyond the termination of the insulation or coatings;
- G At points on the unexposed surface of the *test specimen* deemed to be most susceptible to temperature rises (not shown in Figure 2);
- H Where the grouping of through-penetrating items or the placement of the firestop material does not permit the installation of the thermocouple pad specified in Clause 5.3.3, the size or shape of the thermocouple pad can be modified to accommodate the shape available. Alternatively, the thermocouple may be relocated to a nearby position where similar temperature rise conditions are expected to exist. (Not shown in Figure 2.)

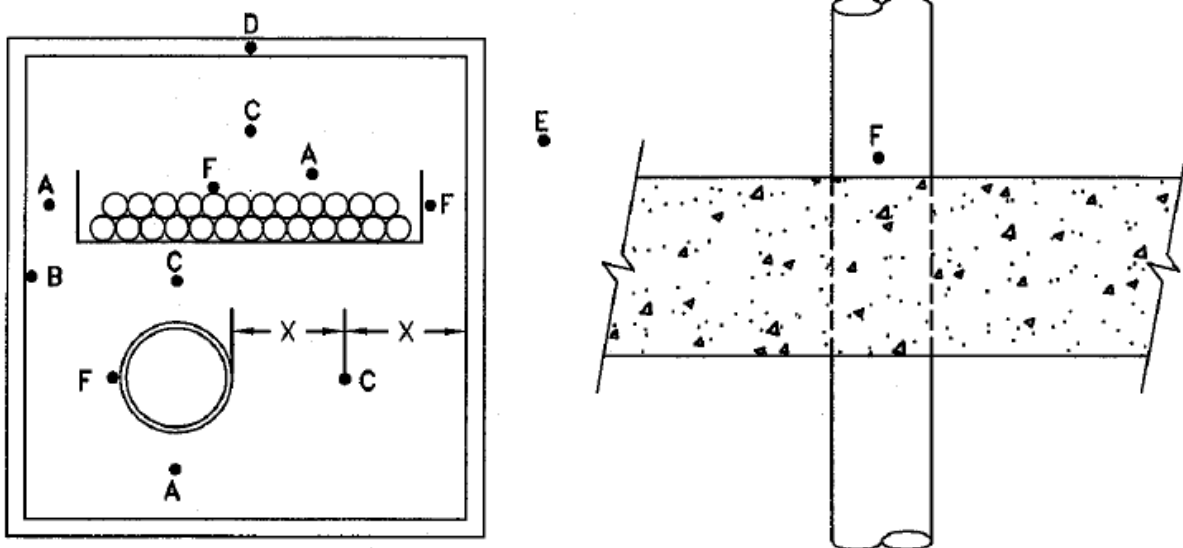

For example Tc#1a, 1b, 1c/e, 1f etc. where Tc#1 references the thermocouple for penetration 1 and the prefixes 'a' to 'g' refer to the locations as depicted in the diagram above. Some thermocouple placements may be common for 2 locations and have been reported as such ie. 1c/e, 3c/e, 4c/e.

4 Testing and Evaluation Methods

4.1. THE FIRE TEST

The test assemblies were mounted on top of the pilot scale fire test furnace.

Furnace temperatures were measured by six uniformly distributed thermocouples. These readings were recorded by a data acquisition system capturing data every 30 seconds and displayed every 5 seconds in real time while monitoring the fire test. See Appendix C – Test Data. The floor assemblies were subjected to the standard time/temperature curve of CAN/ULC S101 and the unexposed surface was observed for the duration of the test.

Furnace pressure was maintained at -0.0050 in W.C. ± 0.01 in W.C. @ 10 in. below the surface of the test assembly within the furnace. The exhaust opening is located along the back of the furnace. Four natural gas burners are located in the furnace floor, as are four secondary air inlets. The pressure was monitored throughout the test duration.

For test assembly no. 2 PVC – XFR [5 – 5/32 in. (131mm) CLT Panel] a pressure box was placed over the test assembly and connected to an air extraction unit to maintain a -50 pascal (-0.203 inches in water column) pressure differential between the furnace and the overhead box.

The furnace pressures and the overhead box pressure (for assembly no. 2) were monitored for each test.

See Appendix C – Test Data.

4.2. THE HOSE STREAM TEST

The hose stream test was not requested for any of the assemblies to be able to obtain the maximum F rating as deemed by CAN ULC S115-11.

5 Testing and Evaluation Results

5.1. RESULTS AND OBSERVATIONS

5.1.1. Observations - Test Assembly No. 1

TIME (min)	EXPOSED SIDE	UNEXPOSED SIDE
0:00	Start of test	
05:00	Furnace pressures stable. Surface charred.	
10:00		Vapor/smoke coming out of cast iron pipe.
11:17	Discoloration of cast iron pipe, data cable wires melted.	
35:00	Small pieces of the first layer of CLT is starting to fall away.	
37:58	Drop in system has expanded and crushed the insulation.	Top cover of drop in system has popped off. No through hole observed.
41:28	First layer of CLT falling off and the new layer has brought added energy into the furnace.	
50:00	CLT pieces continue to fall away from the exposed face.	
60: 45	Intumescent around the pipes have expanded.	
62:00		Light smoke from the surface of the intumescent on the unexposed side.
72:00		Crackling noises heard coming from the assembly.
75:00	Fire impacted CLT exposed to furnace conditions beginning to experience structural failure.	Large increase of smoke around the perimeter of the assembly as it begins to deflect inwards towards the furnace.
78:00	Flaming observed on the unexposed side of the assembly. Test ended.	

After Test Observations:

The test assembly experienced structural failure and was carefully extinguished and moved off the furnace.

5.1.2. Test Assembly No. 2 (with overhead pressure box @ - 50 pascals)

The penetration seal design did not contain intumescent on the exposed face to be able to close the openings hence the pipes were capped from both exposed and non-exposed sides to be able to maintain tests pressures for the entire test duration as required by standard.

TIME (min)	EXPOSED SIDE	UNEXPOSED SIDE
00:00	Start of test	
00:38	Surface beginning to ignite.	Pressure box on 50 Pa differential pressure established
01:53	Pipes reacting to heat and forming a crusty broken up surface.	
03:38	XFR pipe has fallen away to the furnace floor.	
10:21	Sustained flaming on charred surface of the CLT exposed to the fire.	
12:00	PVC pipe has fallen away.	
24:23	Flaming consistent and even on the exposed face.	
35:38	Small pieces starting to fall away from the exposed surface of the CLT panel.	No smoke leaking around the caulking on either penetration within the pressure box.
41:30	Significant sized pieces of CLT starting to fall away to the furnace floor from the exposed face of the assembly. The new face brings with it additional energy into the furnace.	
52:07	Small pieces continuing to falling off the sample on the exposed face.	No smoke leaking through around the caulking.
62:45	CLT pieces from the second layer are starting to fall away.	Sample stable. No change to the unexposed face.
75:00	Test continued. Pieces of CLT still falling away exposing new areas.	
95:53	Approx. 3 layers of the CLT panel have burnt away.	No leakage observed on the unexposed face around the penetration within the pressure box that suggests the intumescent cured enough to form an air tight seal between the penetrating pipe and the CLT panel that was maintained under conditions of negative 50pascals.
100:00	End of test declared as requested by client representative from GHL. No leakage was observed on the unexposed face inside the pressure at any location for the entire duration of the test.	

After Test Observations:

The exposed face of the assembly was carefully extinguished and the cavity of the penetrating pipes were observed to be completely open through the floor assembly. The unexposed side of the assembly was intact and no leakage was observed between the CLT floor and the penetrating pipes through the cured intumescent caulking under a negative pressure exposure of -50 pascals.

The test assembly did not achieve a rating because the pipe openings could not be closed by the intumescent caulking that was installed on the unexposed face only as the temperatures experienced were not hot enough to allow it to react and crush the pipe opening.

5.1.3. Test Assembly No. 3

TIME (min)	EXPOSED SIDE	UNEXPOSED SIDE
0:00	Start of test	
01:21	Surface ignition.	
05:00	Furnace pressures stable. Even flaming on the exposed face.	
08:45	Plastic sheathing of cable penetration has melted away.	
13:30	Drop in system has reacted and intumescent has closed off the exposed face.	Unexposed face cove of the drop in system has popped off. No through hole observed .
18:45	Light vapor observed on the unexposed face of the caulking as the pipes conduct heat through.	
34:00		Intumescent around the copper pipe has expanded.
35:30	Small pieces of exposed layer of CLT starting to fall off.	
41:07	New layer of CLT exposed bringing additional energy into the furnace.	
55:23		Some thermocouples have moved from their initial locations as the intumescent seals expand.
58:33		Intumescent caulking around most penetrations have expanded and are releasing vapor.
75:00	3 rd layer of CLT beginning to char as the previous layer falls away in pieces.	
87:00		Slight deflections of the assembly observed.
99:23	Furnace temperature spike observed as 4 th CLT layer exposure to furnace conditions adds energy into the furnace.	
102:30	Crackling noise.	
116:00		Expansion of firestop caulking observed around all penetrations
120:00	End of test declared.	

After Test Observations:

The exposed face of the assembly was carefully extinguished and the sample was allowed to cool. The assembly was slightly deflected but still retained enough strength to retain the weight of all the penetrating items. The charred face was pried off using a shovel to access the underlying CLT layers to be able to cool down the CLT assembly safely.

After the surface was cooled and extinguished the view from the exposed side of the assembly showed the intumescent caulking had cured evenly.

6 Conclusion

The CLT Floor assemblies were non-traceable samples sent directly to the Intertek test facility in Coquitlam BC from Nordic Structures production facility in Chibougamau. The composition, manufacturing techniques and quality assurance procedures have not been witnessed by Intertek and is not under our Listing and Follow-up Service program.

The test specimens as described did not allow flames to penetrate through the firestop system seals at any time during their described test periods as per the observations in section 5 of this report.

The ratings determined for the penetrations and firestop materials, installed as described in this report and test in accordance with ULC S115-11, *Standard Method of Fire Tests of Firestop Systems* are as follows:

Test Assembly No. 1

Item (size & type)	Opening (size)	Annular Space (min/max)	Firestop System	ULC S115-11		
				F	T	FT
Data Cable Bunch 1 – ½in. (38.1mm) Dia.	3 – ½in. (89mm)	1in. (25.4mm)	Mineral wool was installed in the 1in. annular space around the data cables to a total depth of approximately 2 – 5/64in. (52.8mm). The remaining 1in. annular space (25.4mm) from the top of the mineral wool to the top of the floor assembly was filled with Hilti FS-One Max caulking.	1 hr	½ hr	½ hr
Copper Pipe 2in. (50.8mm) Dia.	4 – 3/8in. (111mm)	1in. (25.4mm)	Pipe wrap was installed around the copper pipe to a total depth of approximately 2 – 5/64in. (52.8mm). The remaining 1in. annular space starting at the top of the mineral wool to the top of the floor assembly was filled with Hilti FS-One Max caulking.	1 hr	-	-
Schedule 40 2 – ½in. (63.5mm) Dia.	4 – 59/64in. (125mm)	1in. (25.4mm)	Pipe wrap was installed around the schedule 40 pipe to a total depth of approximately 2 – 5/64in. (52.8mm). The remaining 1in. annular space starting at the top of the pipe wrap to the top of the floor assembly was filled with Hilti FS-One Max caulking.	1 hr	-	-
Cast Iron 6in. (152.4mm) Dia.	8 – 11/32in. (212mm)	1in. (25.4mm)	Mineral wool was installed in the 1in. annular space around the cast iron pipe to a total depth of approximately 2 – 5/64in. (52.8mm). The remaining 1in. annular space starting at the top of the pipe wrap to the top of the floor assembly was filled with Hilti FS-One Max caulking.	1 hr	-	-

Hilti 6in. (152.4mm) Drop-In Device System No.: F- B-2049	9 – 1/64in. (229mm)	1in. (25.4mm)	Mineral wool was installed in the 1 – 1/4in. annular space around the drop-in device to a total depth of approximately 1 – 7/64in. (28mm) and the remaining 1in. annular space from the top of the mineral wool to the top edge of the 9 – 1/64in. hole in the CLT was filled with Hilti FS-One Max caulking.	1 hr	3/4 hr	3/4 hr
---	------------------------	------------------	---	------	--------	--------

Test Assembly No. 2

Item (size & type)	Opening (size)	Annular Space (min/max)	Firestop System	ULC S115-11		
				*F	*T	*FT
PVC-IPEX Aqualise Pipe 2in. (50.8mm) Dia.	4 – 3/8in. (111mm)	1in. (25.4mm)	Mineral wool was installed around the pipe to a total depth of approximately 4 – 5/32in. (105.6mm). The remaining 1in. annular space starting at the top of the mineral wool to the top of the floor assembly was filled with Hilti FS-One Max caulking.	-	-	-
XFR Pipe 3in. (76.2mm) Dia.	5 – 25/64in. (137mm)	1in. (25.4mm)	Mineral wool was installed around the pipe to a total depth of approximately 4 – 5/32in. (105.6mm). The remaining 1in. annular space starting at the top of the mineral wool to the top of the floor assembly was filled with Hilti FS-One Max caulking.	-	-	-

*Note: No rating has been awarded to the PVC or XFR penetrations.

Test Assembly No. 3

Item (size & type)	Opening (size)	Annular Space (min/max)	Firestop System	ULC S115-11		
				F	T	FT
Copper Pipe 2in. (50.8mm) Dia.	4 – 3/8in. (111mm)	1in. (25.4mm)	Pipe wrap was installed around the copper pipe to a total depth of approximately 4 – 5/32 in. (105.6mm). The remaining 1in. annular space starting at the top of the mineral wool to the top of the floor assembly was filled with Hilti FS-One Max caulking.	2 hr	-	-
Data Cable Bunch 1 – 1/2in. (38.1mm) Dia.	3 – 1/2in. (89mm)	1in. (25.4mm)	Mineral wool was installed in the 1in. annular space around the data cables to a total depth of approximately 4 – 5/32 in. (105.6mm). The remaining 1in. annular space (25.4mm) from the top of the mineral wool to the top of the floor assembly was filled with Hilti FS-One Max caulking.	2 hr	1 1/2 hr	1 1/2 hr

Schedule 40 2 – ½in. (63.5mm) Dia.	4 – 59/64in. (125mm)	1in. (25.4mm)	Pipe wrap was installed around the schedule 40 pipe to a total depth of approximately 4 – 5/32 in. (105.6mm). The remaining 1in. annular space starting at the top of the pipe wrap to the top of the floor assembly was filled with Hilti FS-One Max caulking.	2 hr	½ hr	½ hr
Cast Iron 6in. (152.4mm) Dia.	8 – 11/32in. (212mm)	1in. (25.4mm)	Mineral wool was installed in the 1in. annular space around the cast iron pipe to a total depth of approximately 4 – 5/32 in. (105.6mm). The remaining 1in. annular space starting at the top of the pipe wrap to the top of the floor assembly was filled with Hilti FS-One Max caulking.	2 hr	-	-
Hilti 6in. (152.4mm) Drop-In Device System No.: F-B-2049	9 – 1/64in. (229mm)	1in. (25.4mm)	Mineral wool was installed in the 1 – ¼in. annular space around the drop-in device to a total depth of approximately 1 – 7/64in. (28mm) and the remaining 1in. annular space from the top of the mineral wool to the top edge of the 9 – 1/64in. hole in the CLT was filled with Hilti FS-One Max caulking.	2 hr	1 ½ hr	1 ½ hr

The conclusions of this test report may not be used as part of the requirements for Intertek product certification. Authority to Mark must be issued for a product to become certified.

INTERTEK TESTING SERVICES NA LTD.

Witnessed/
Reported by:

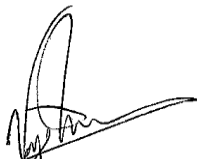

Vijay Lucas
Technical Analyst – Fire

Reviewed by:



Greg Philp
Reviewer – Fire Testing

APPENDIX A

Construction Details

Test Assembly No. 1 [3 – 5/64 in. (78mm) CLT Panel w/ 5 penetrations]

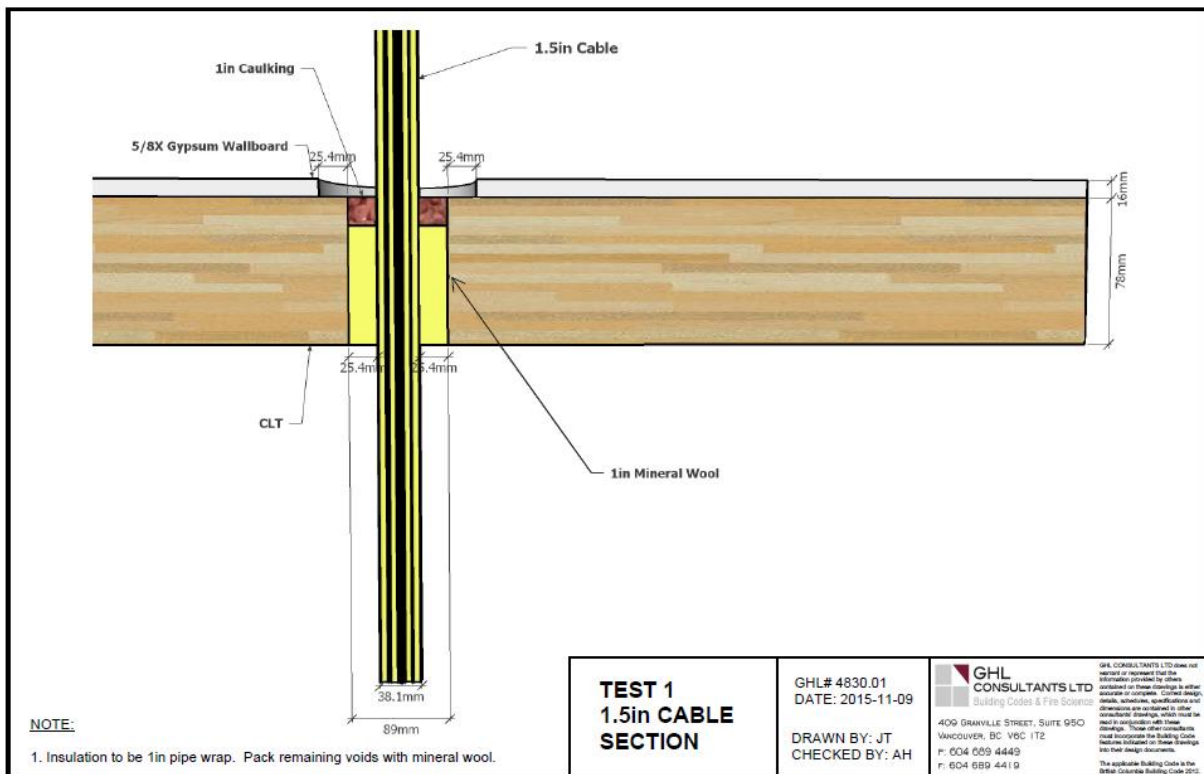
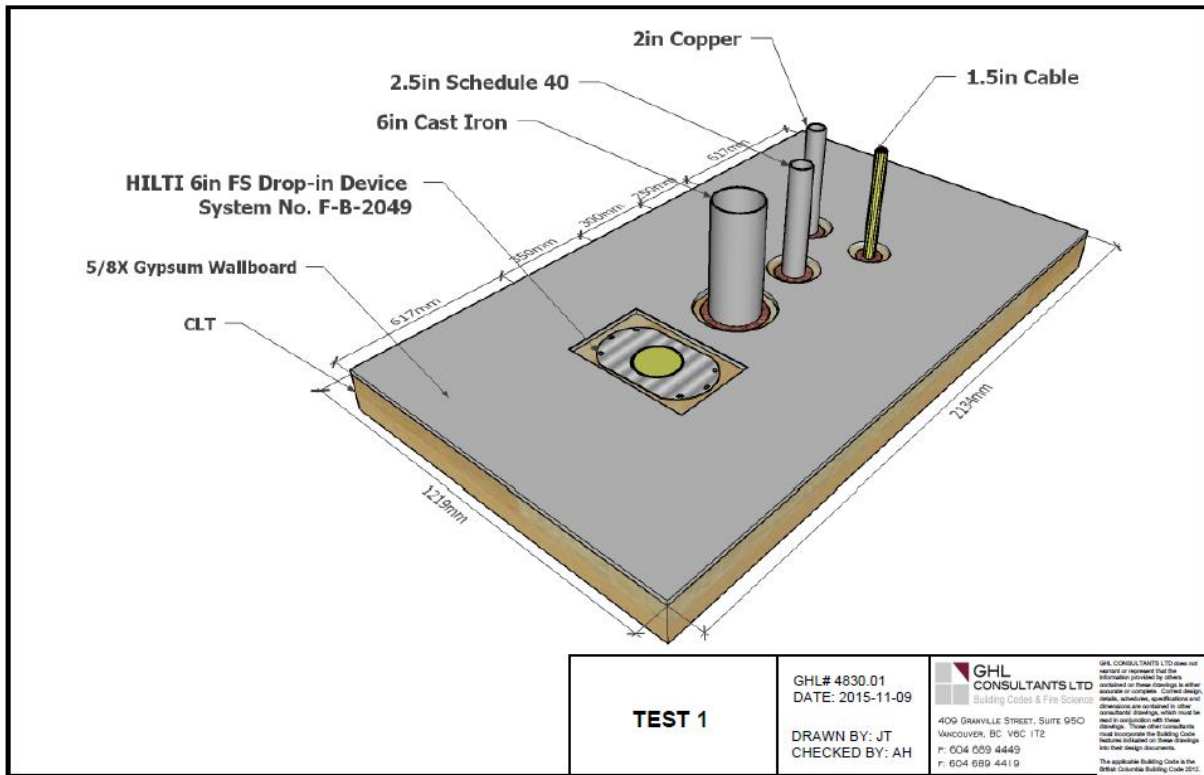

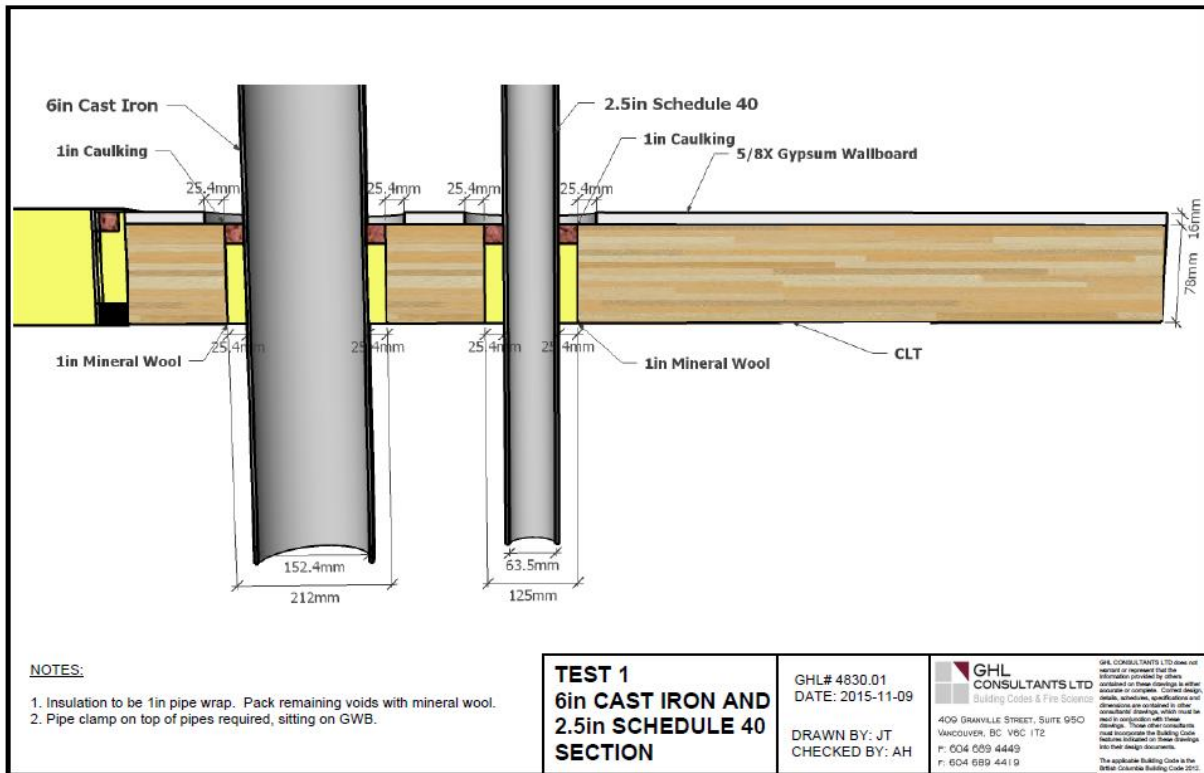
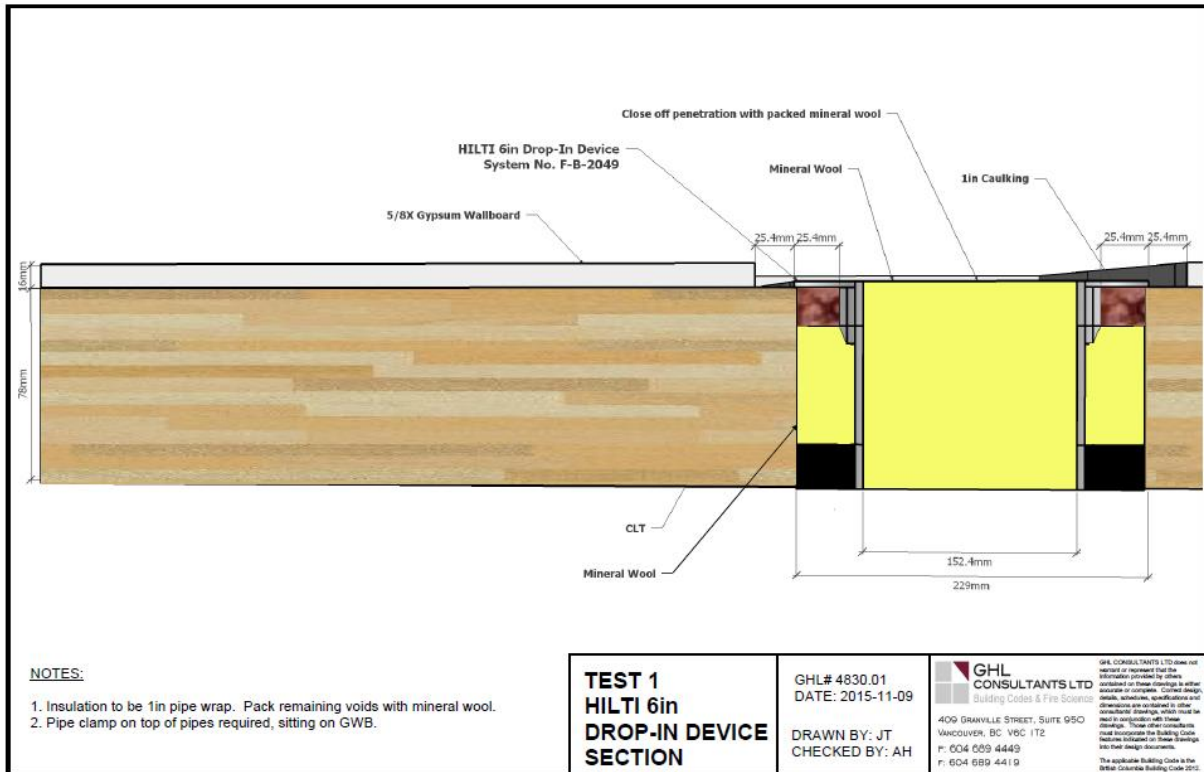

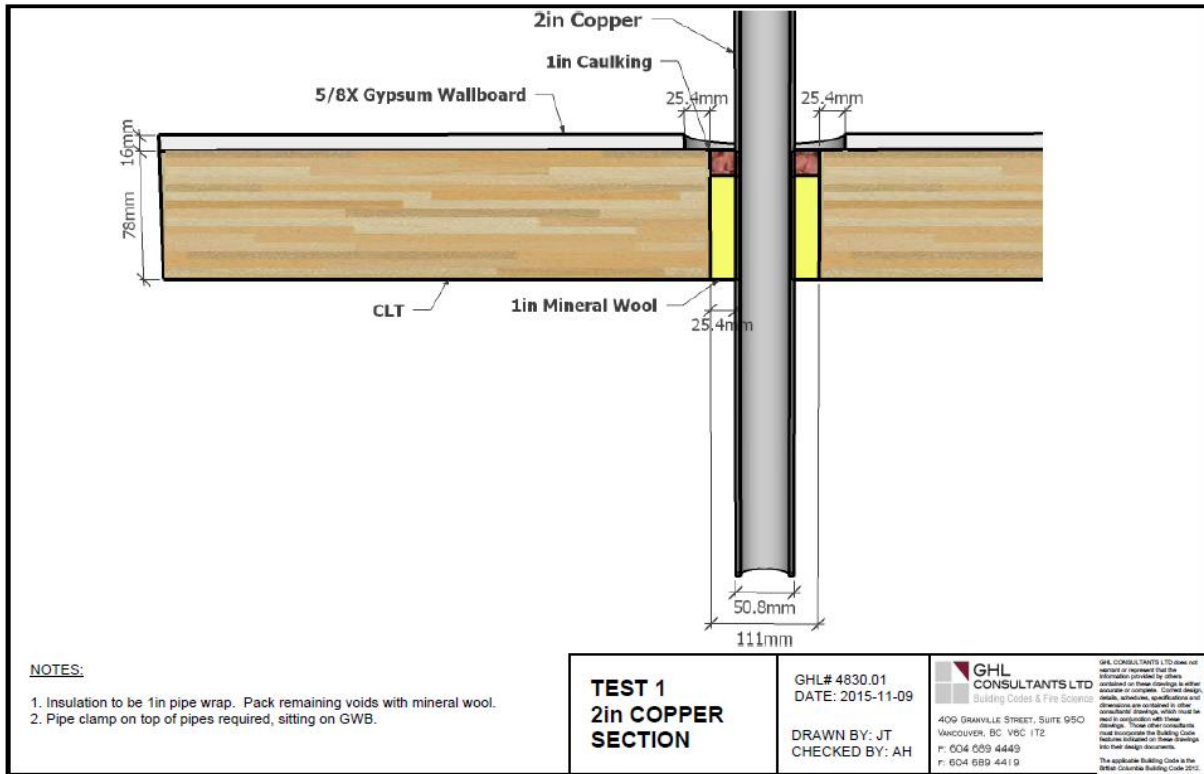

Test Assembly No. 2 [5 – 5/32 in. (131mm) CLT Panel w/ 2 penetrations]

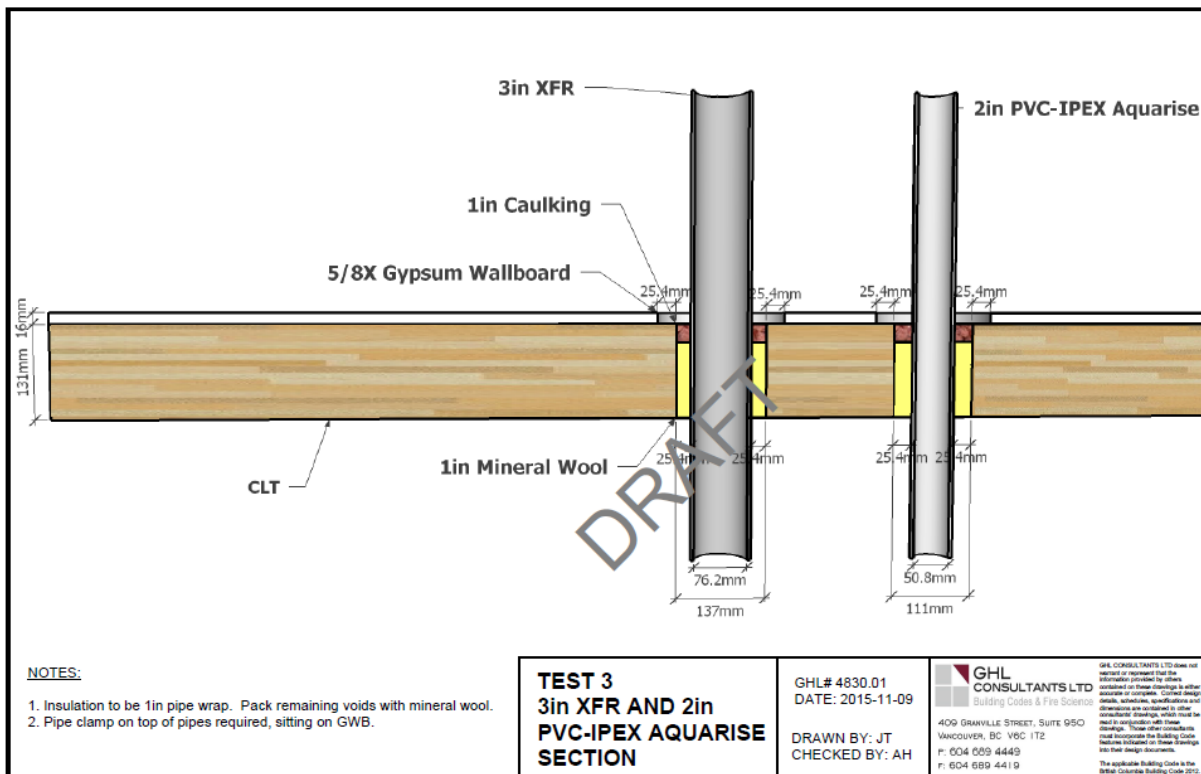
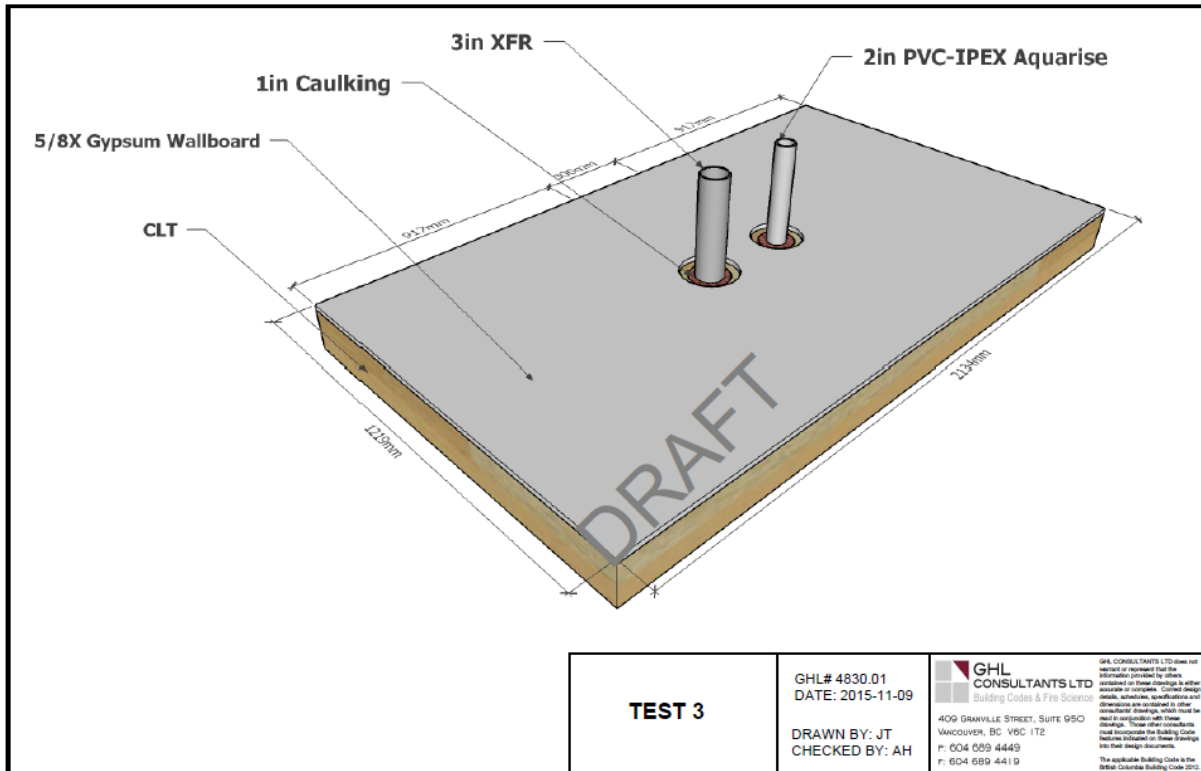

NOTES:

1. Insulation to be 1in pipe wrap. Pack remaining voids with mineral wool.
2. Pipe clamp on top of pipes required, sitting on GWB.

Test Assembly No. 3 [5 – 5/32in. (131mm) CLT Panel w/ 5 penetrations]

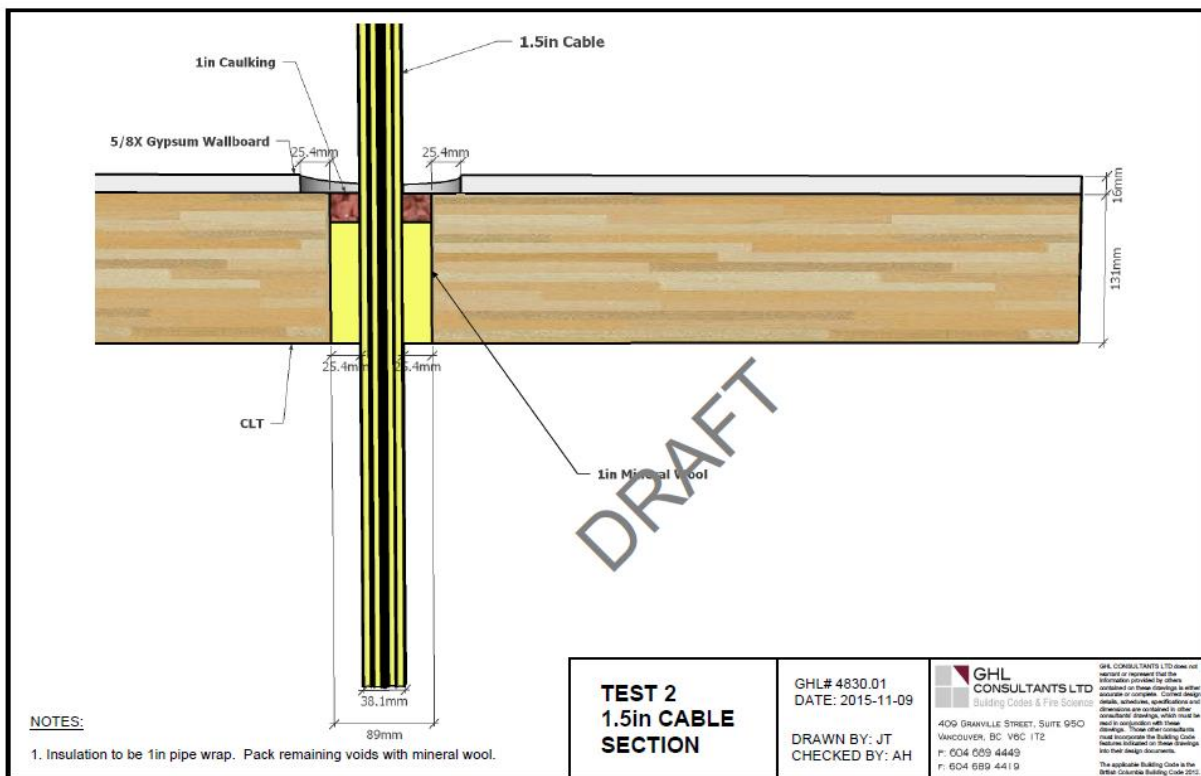
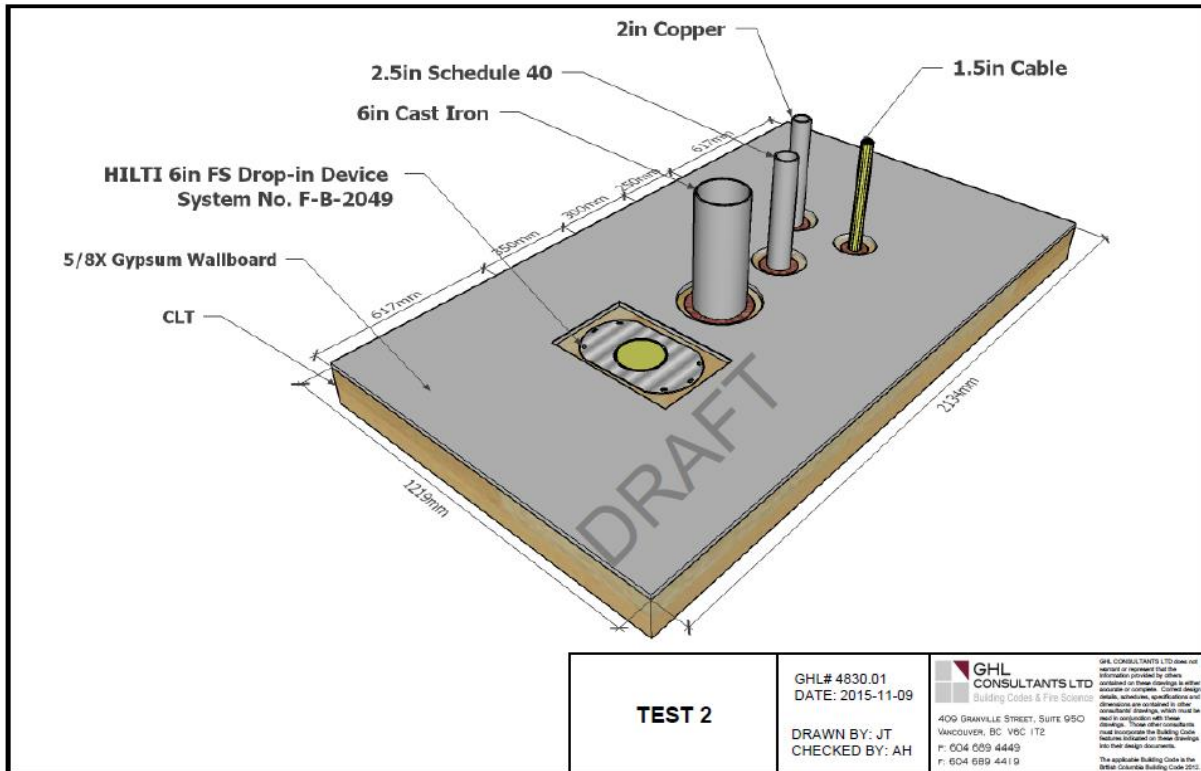

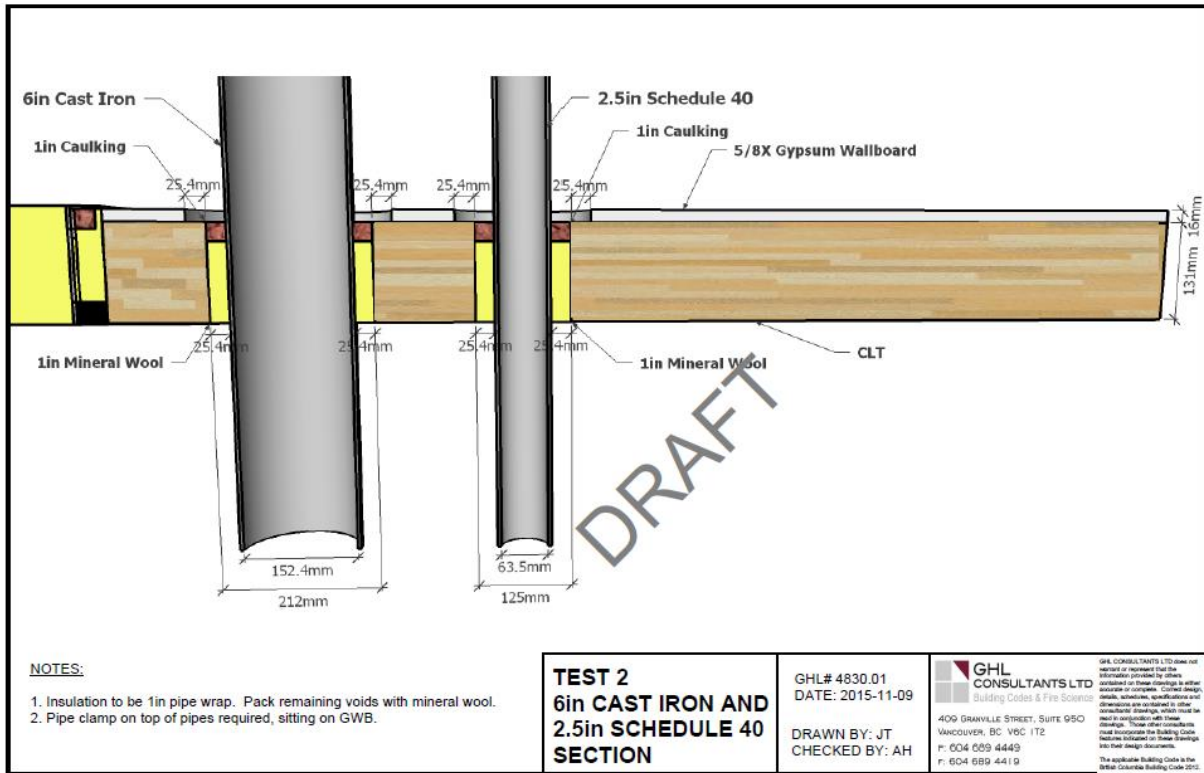
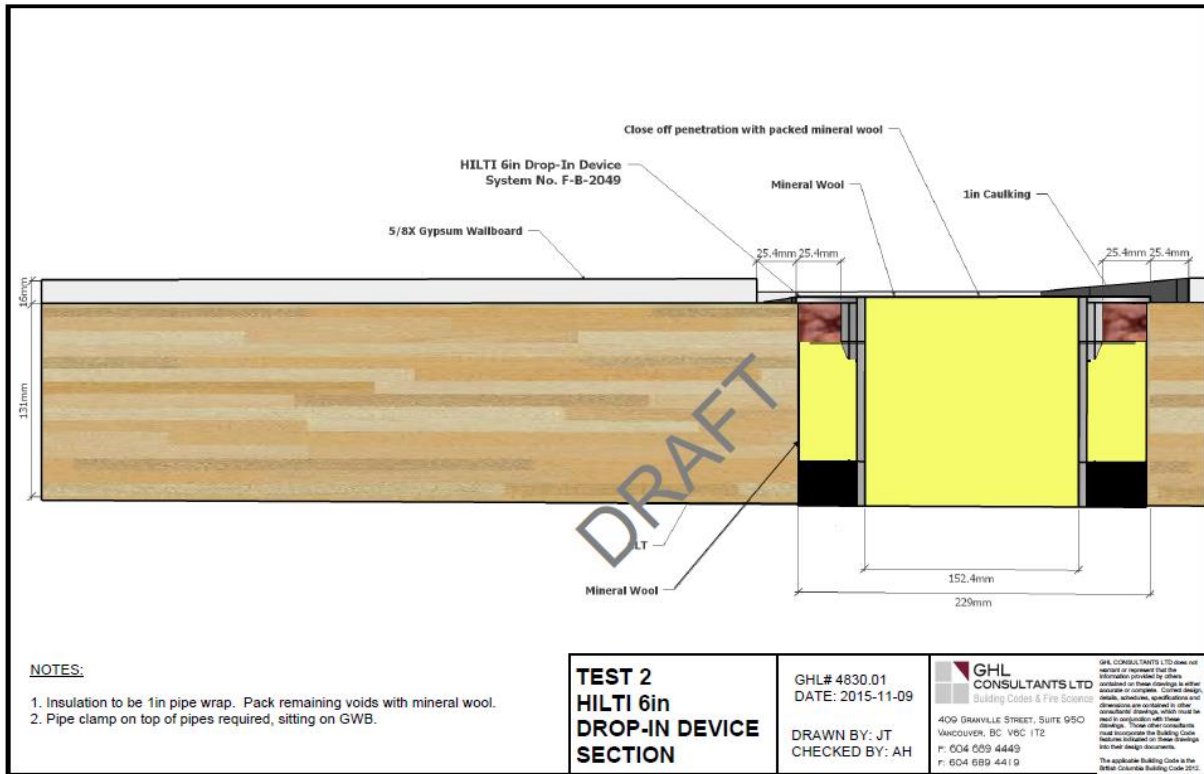

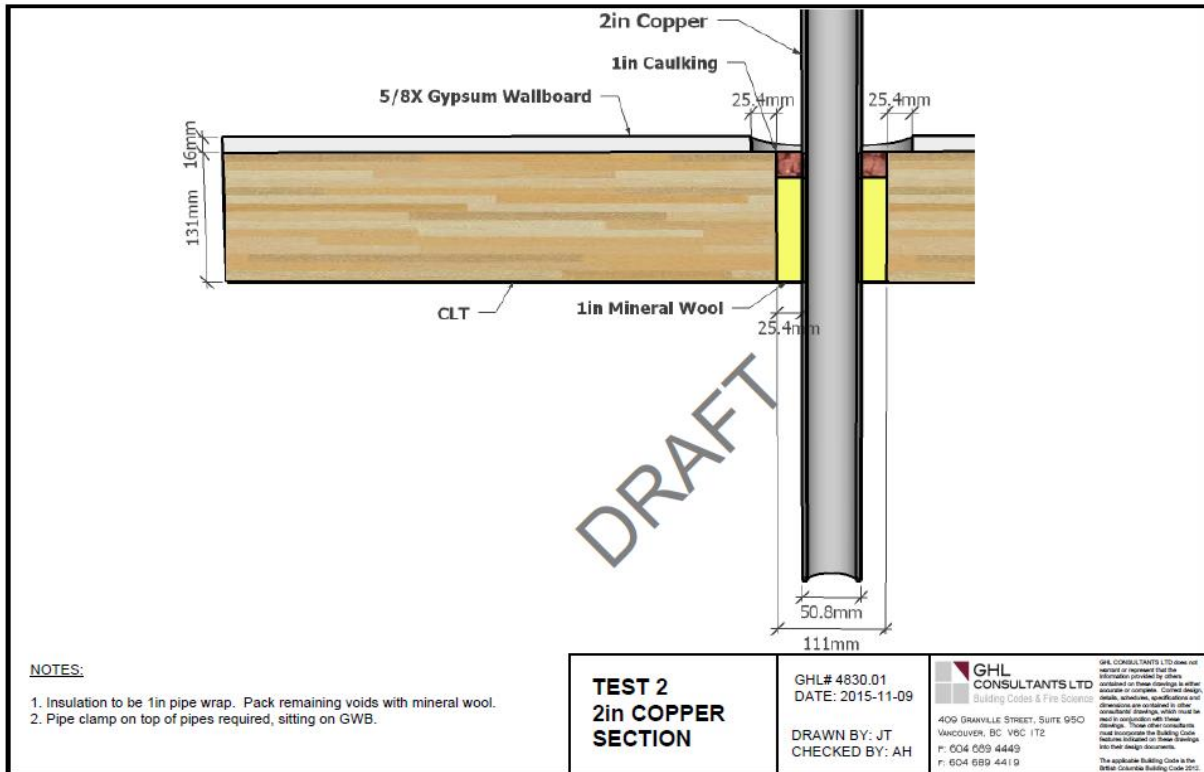

APPENDIX B

Test Data

Test Assembly No. 1 [3 – 5/64 in. (78mm) CLT Panel w/ 5 penetrations]

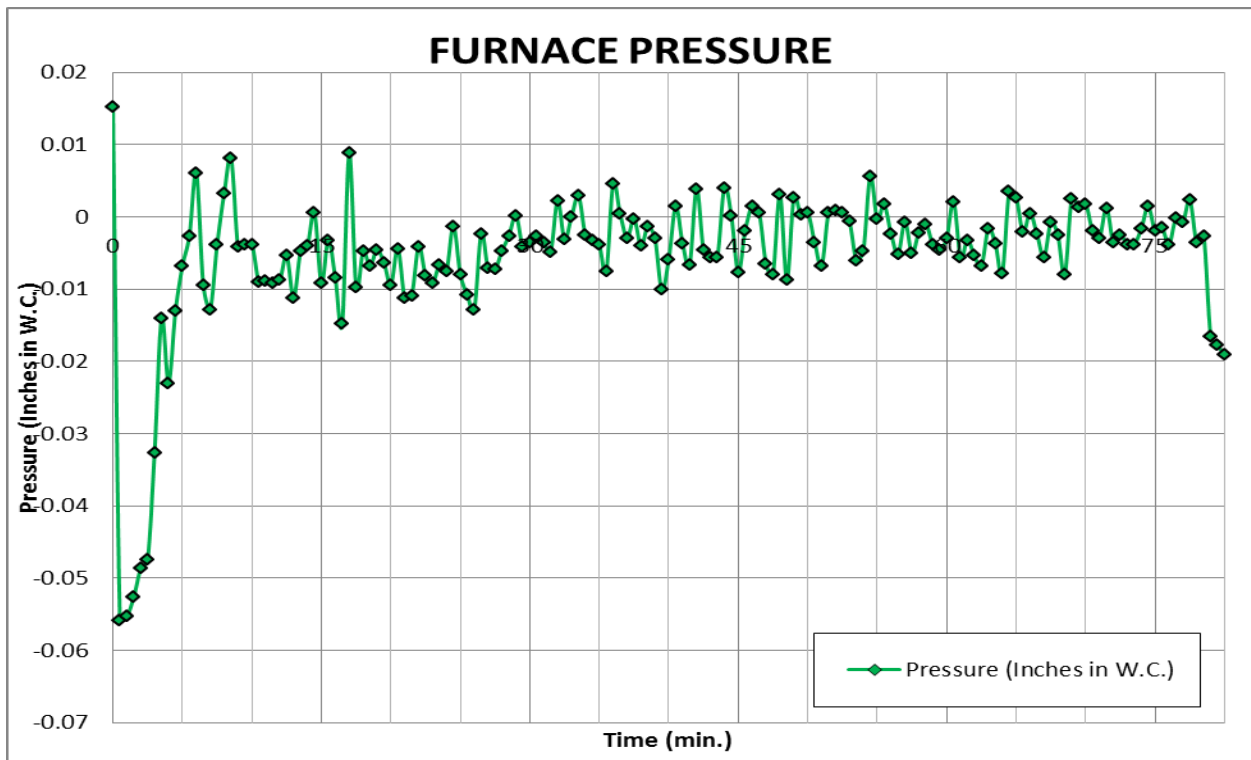
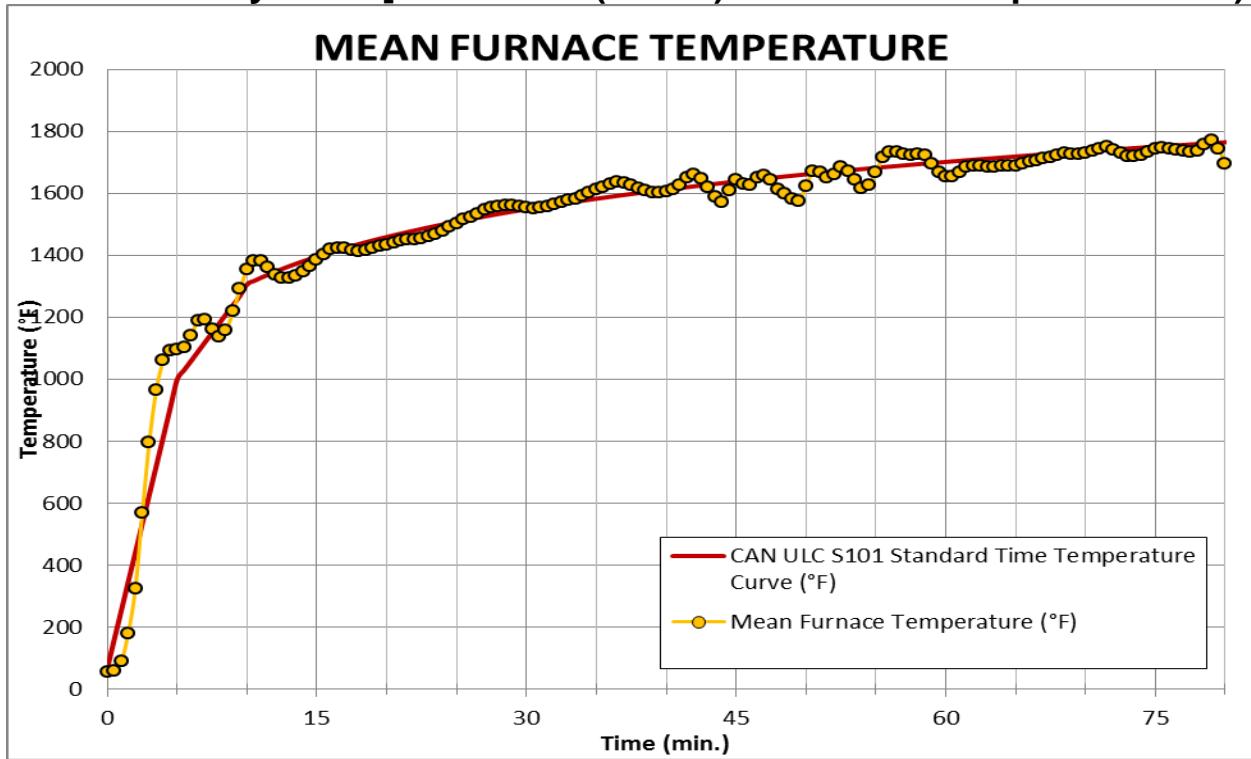

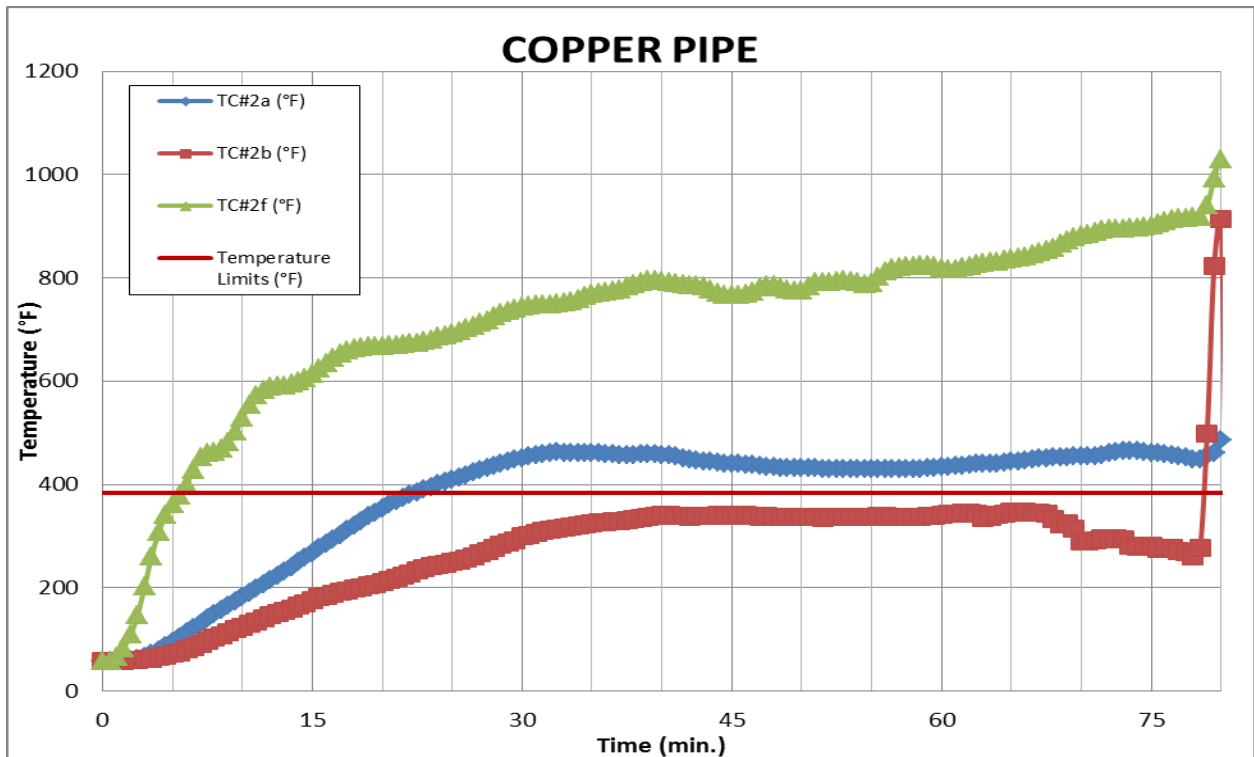
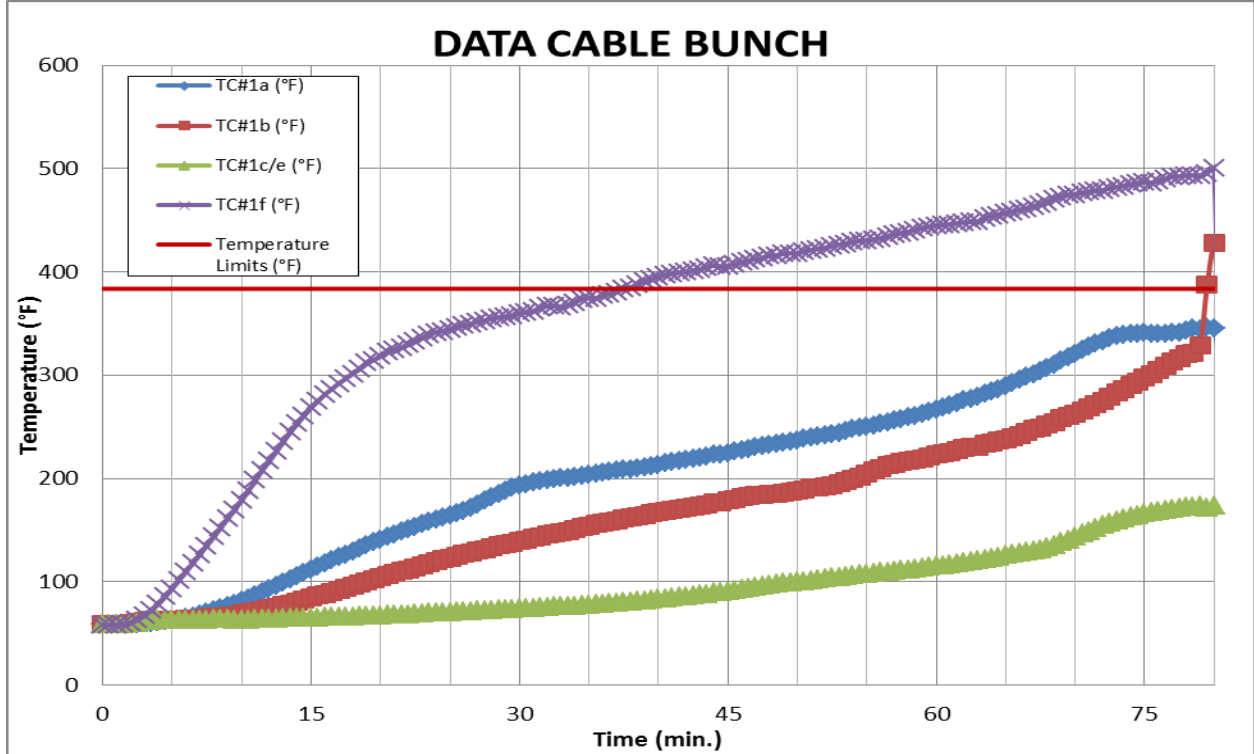

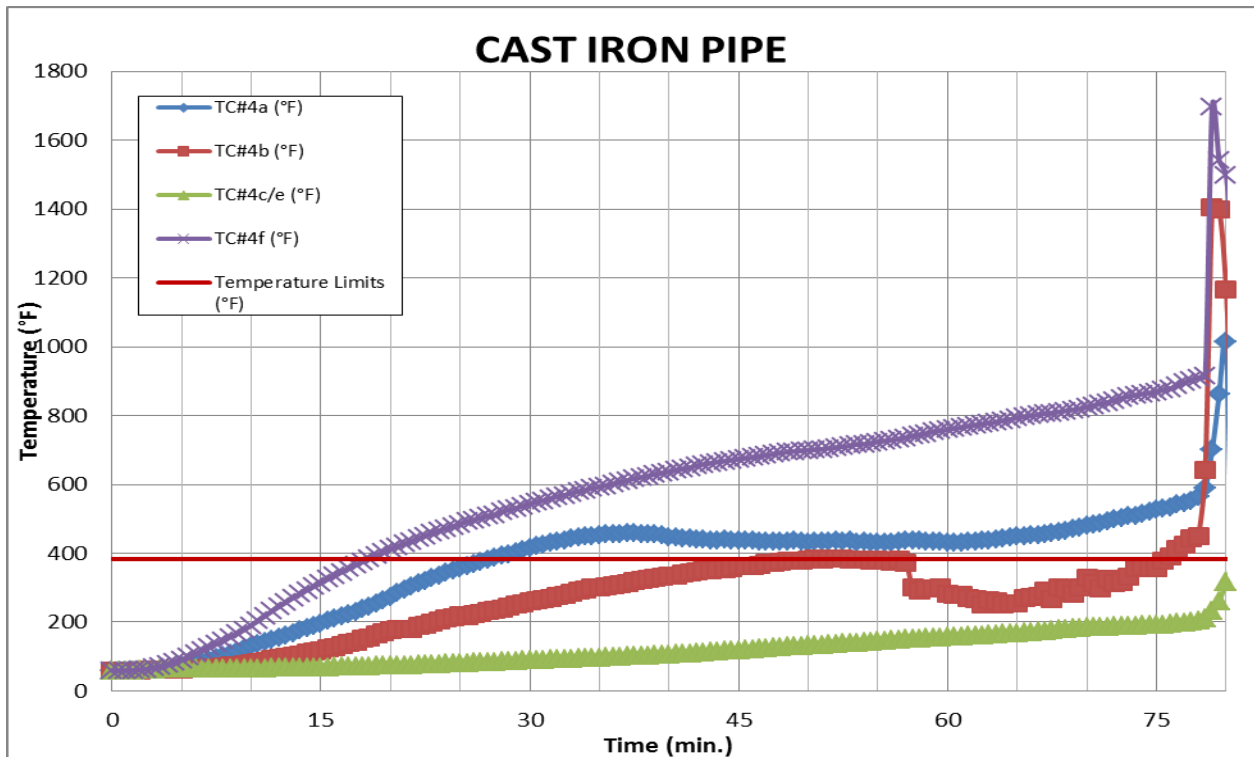
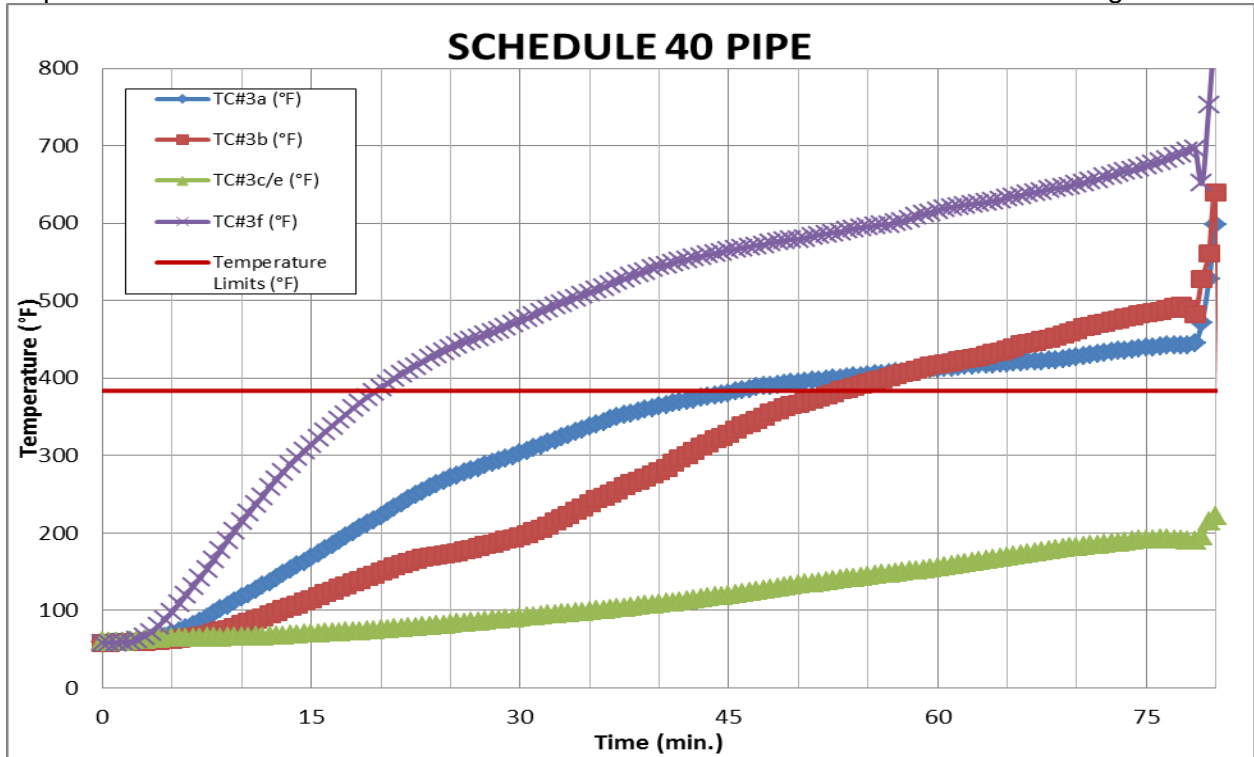

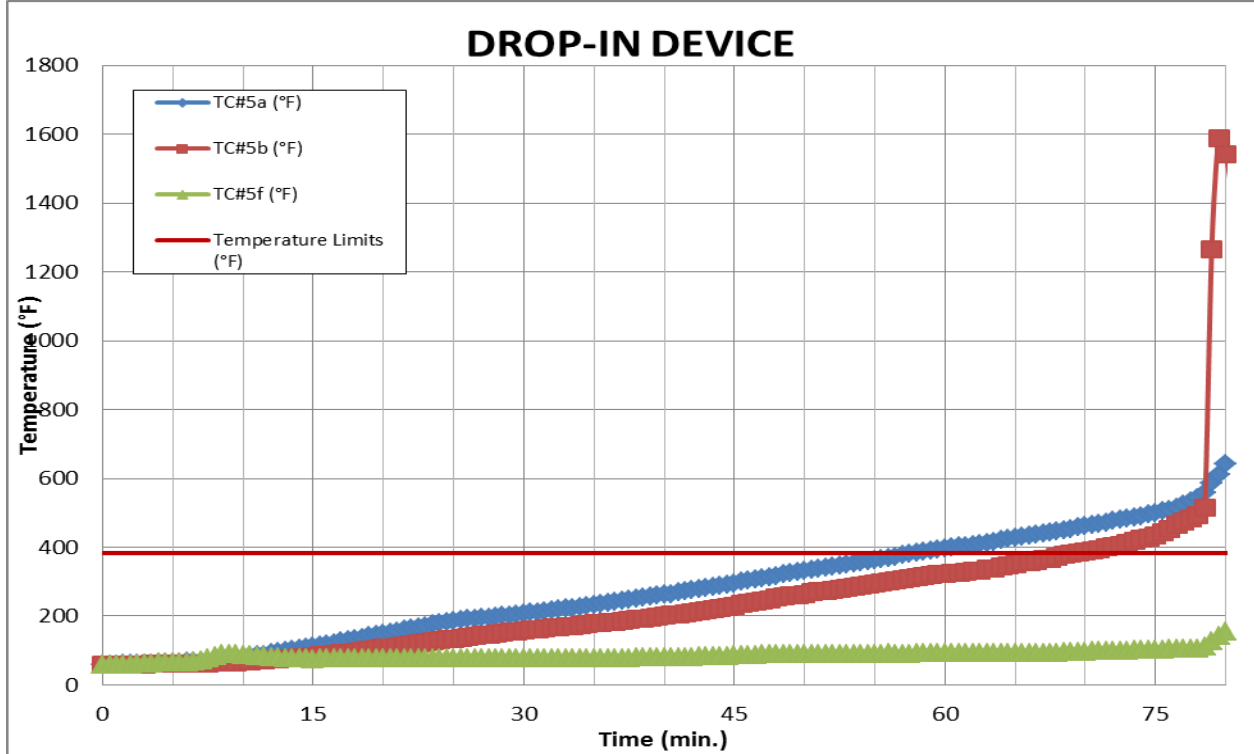

Test Assembly No. 2 [5 – 5/32 in. (131mm) CLT Panel w/ 2 penetrations]

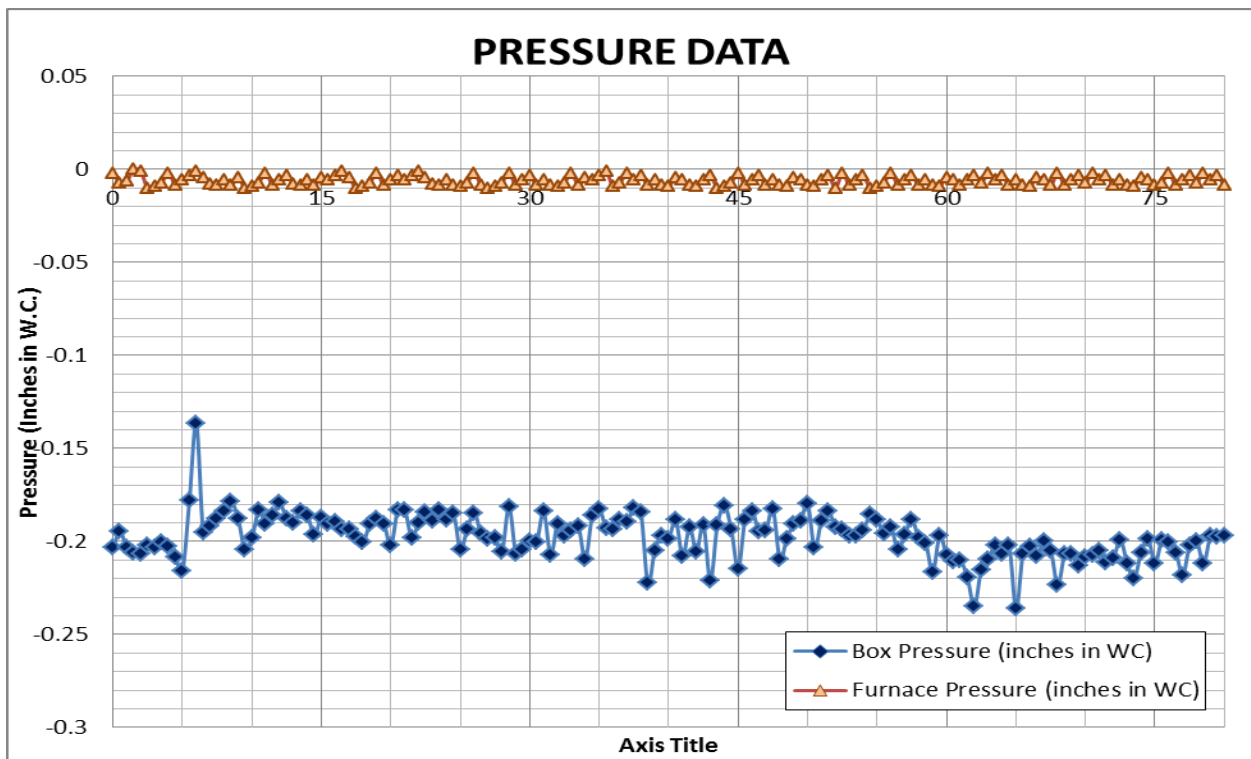
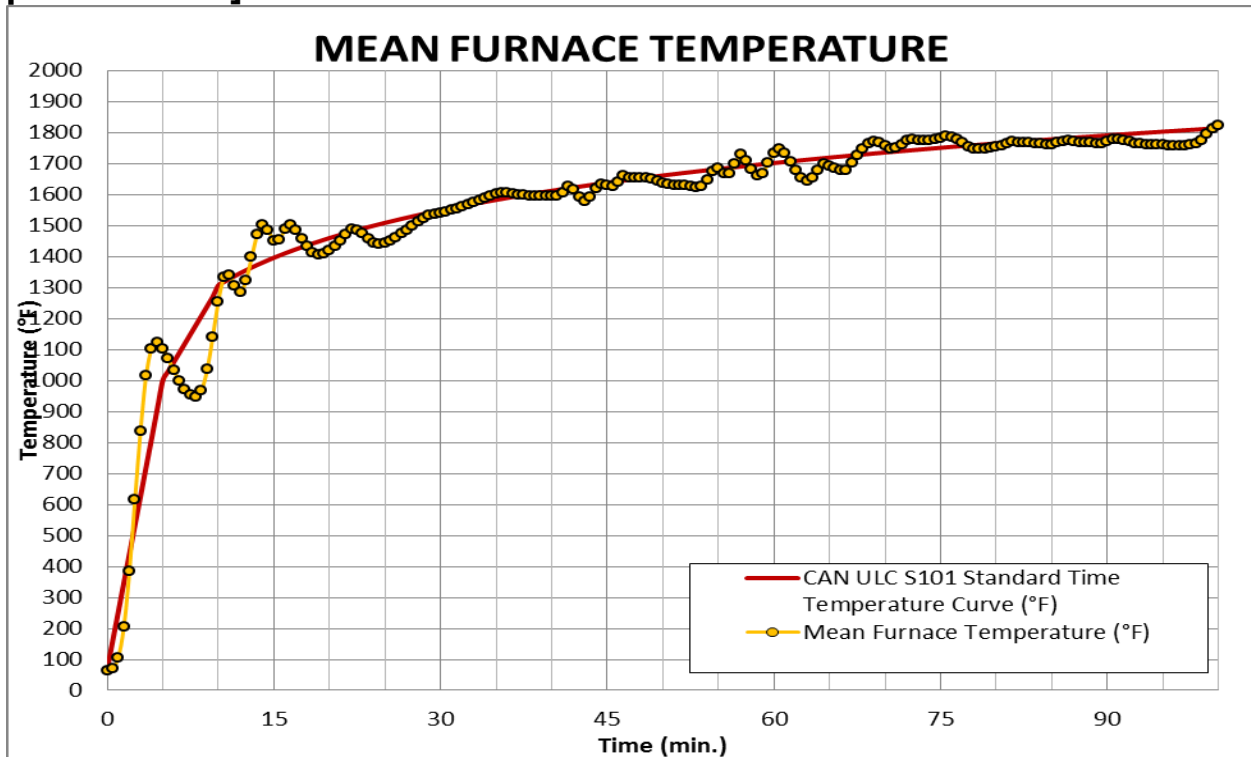

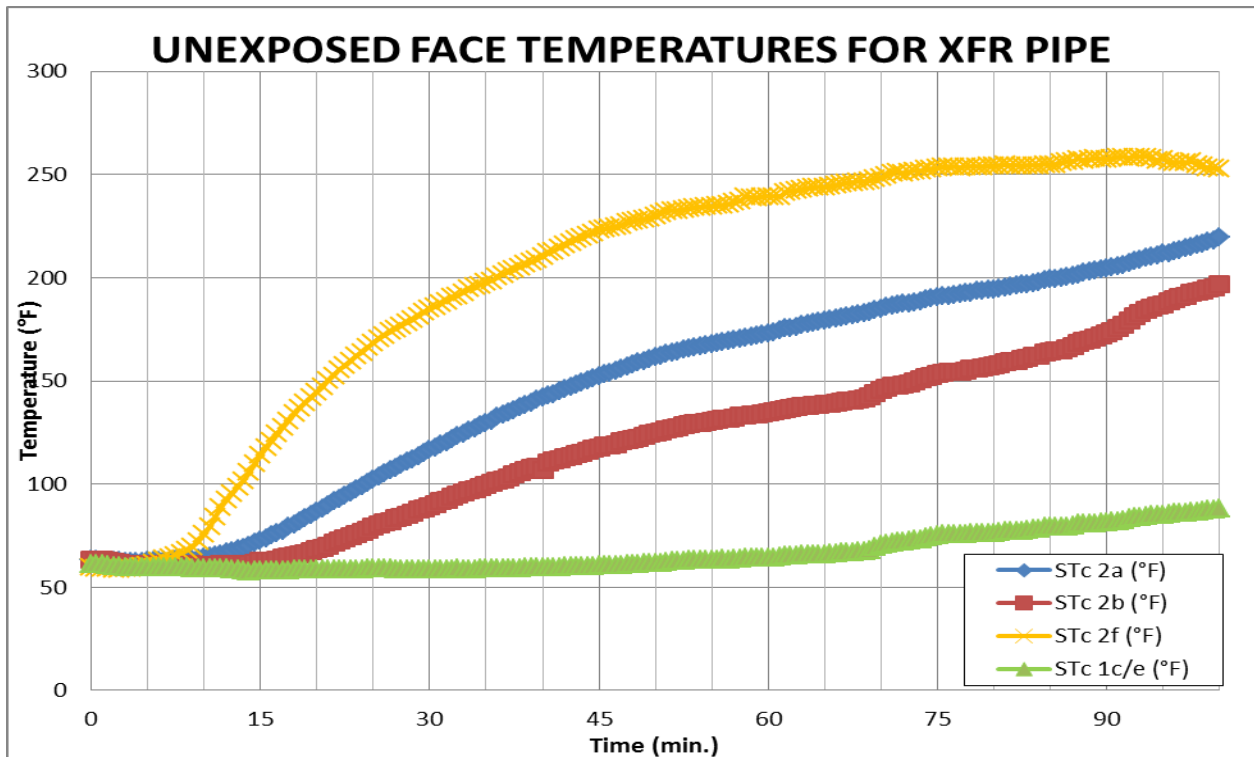
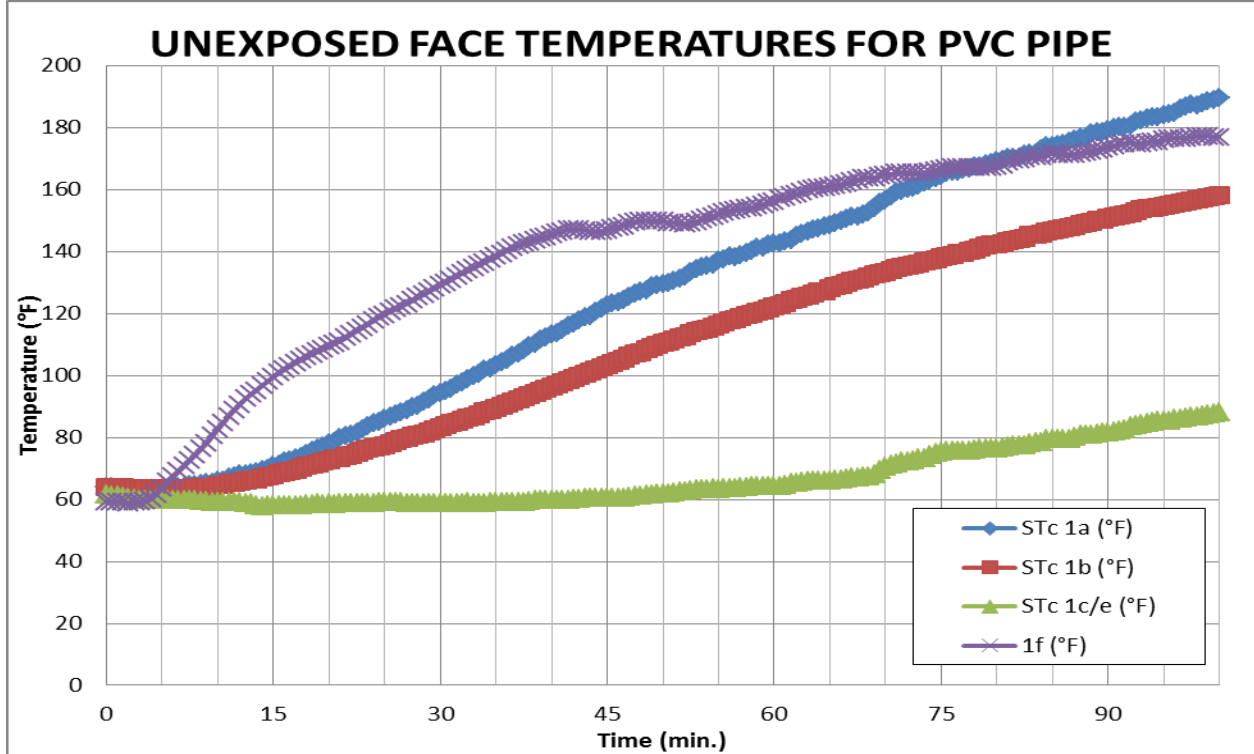

Test Assembly No. 3 [5 – 5/32 in. (131mm) CLT Panel w/ 5 penetrations]

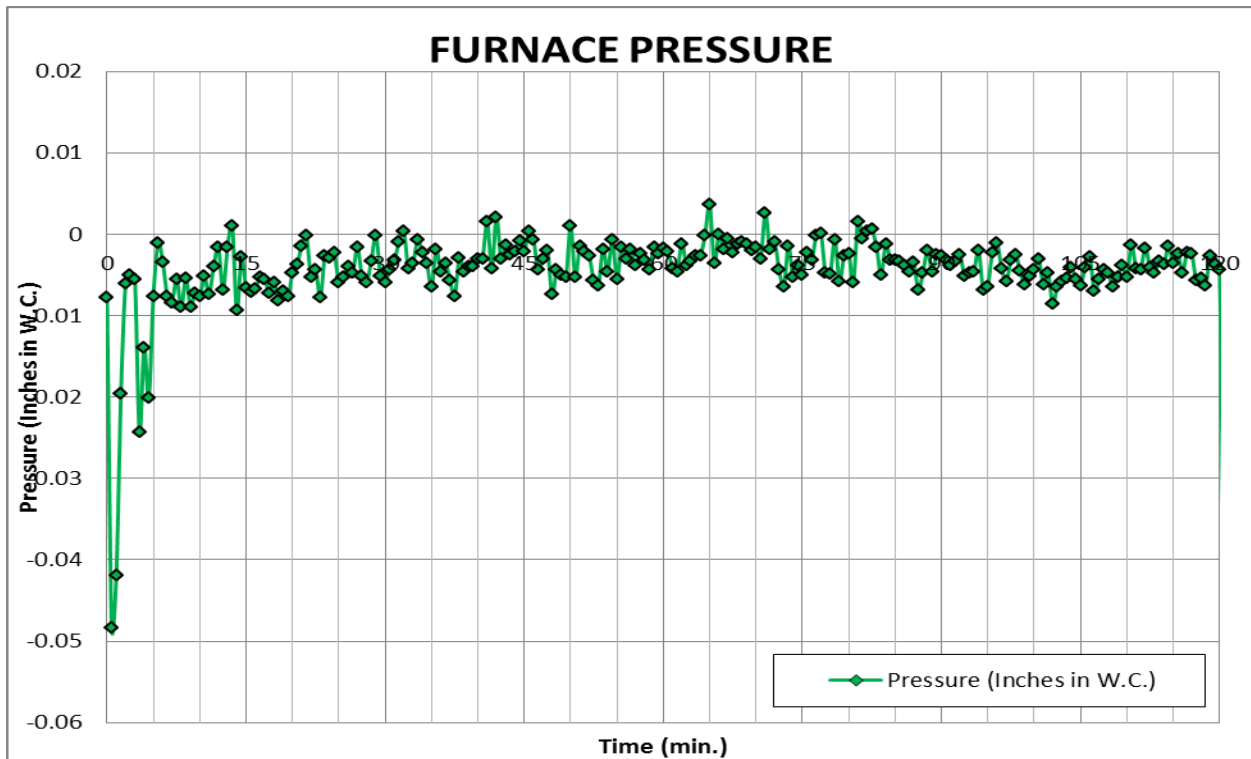
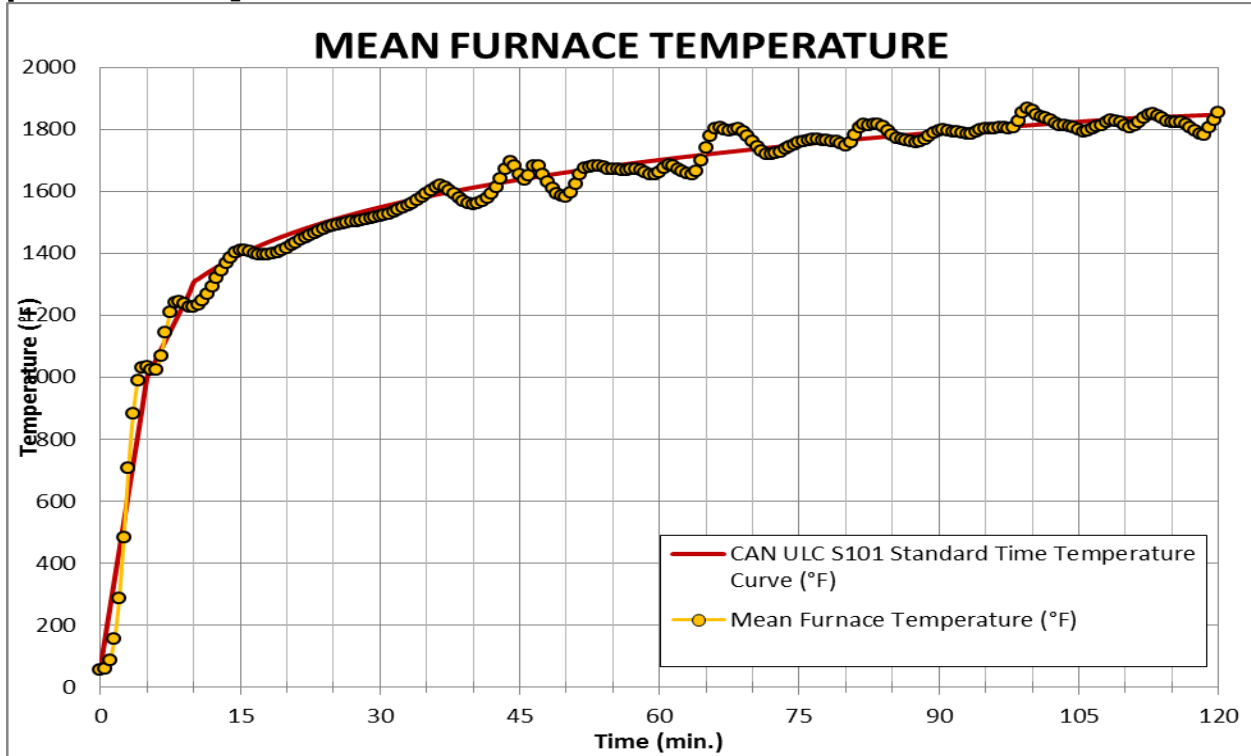

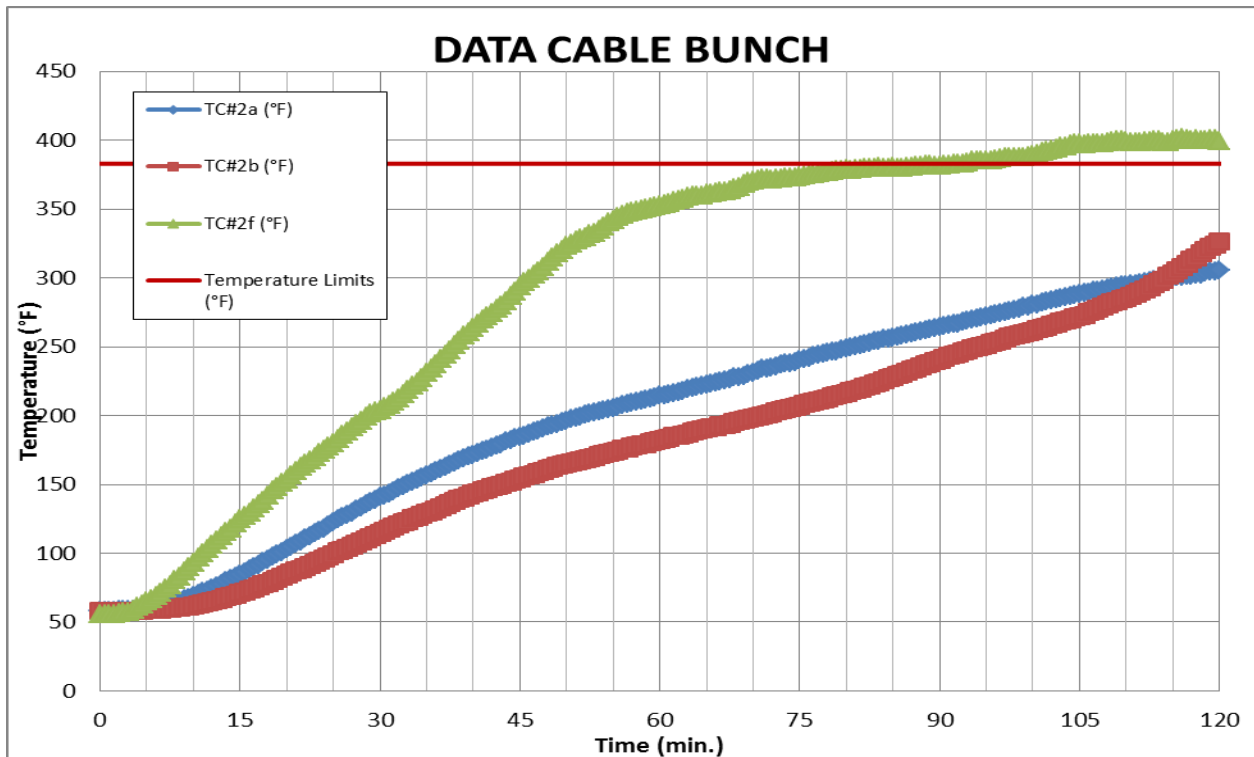
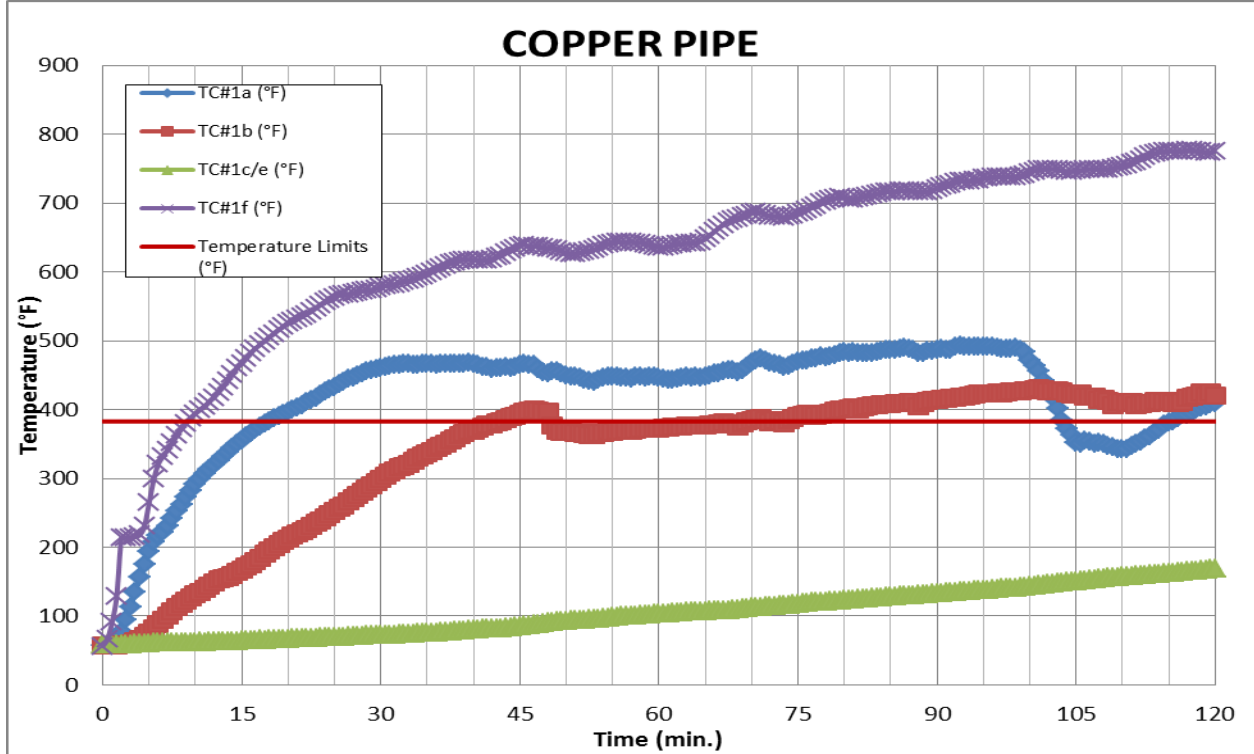

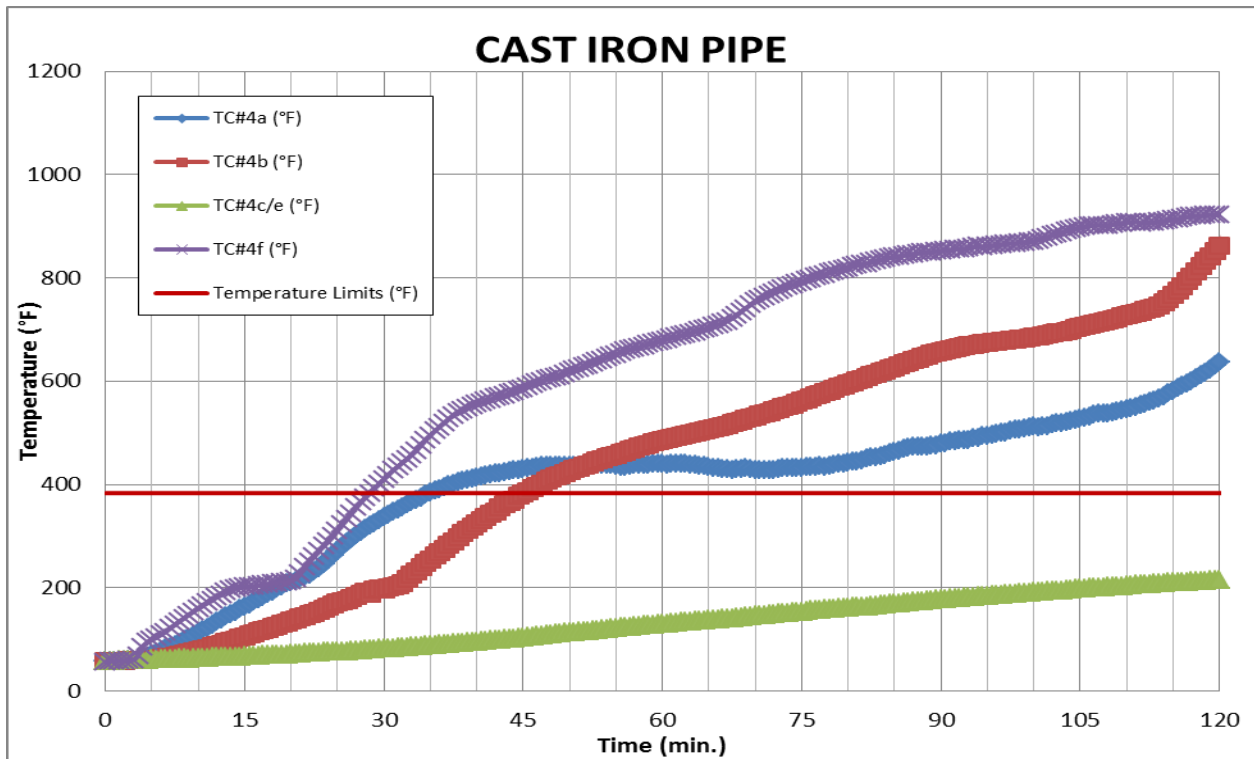
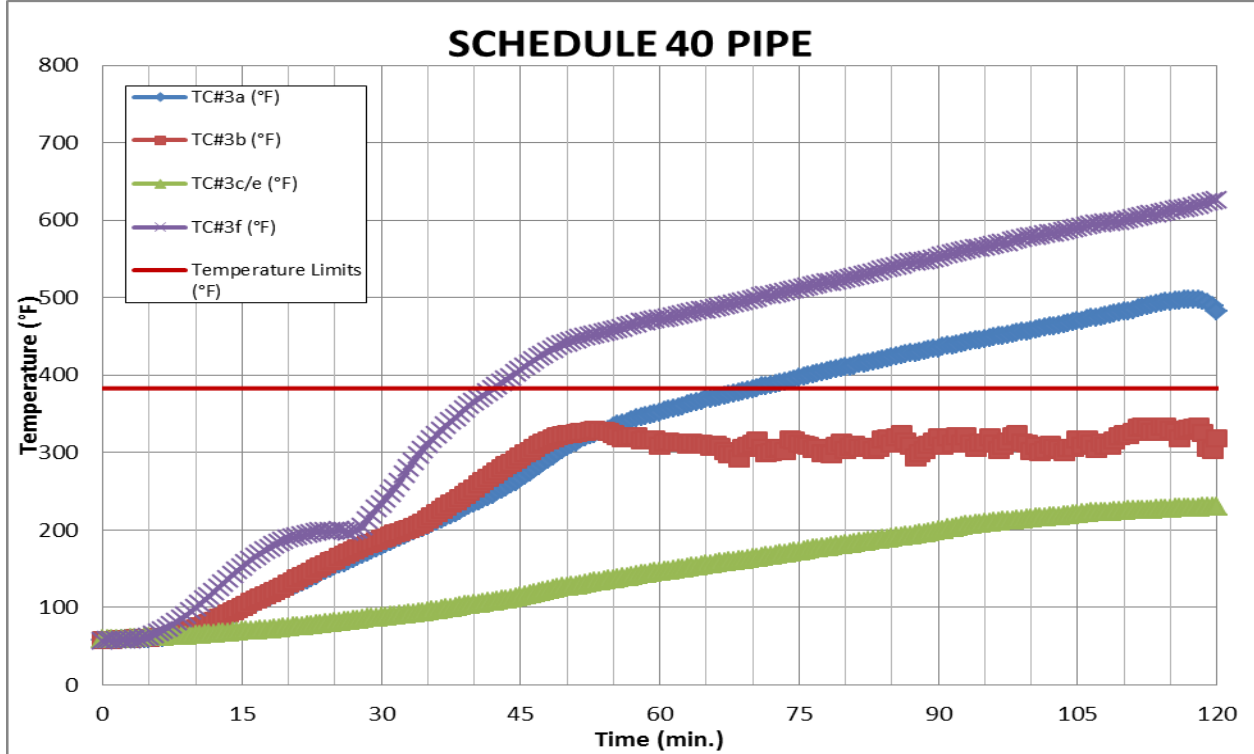

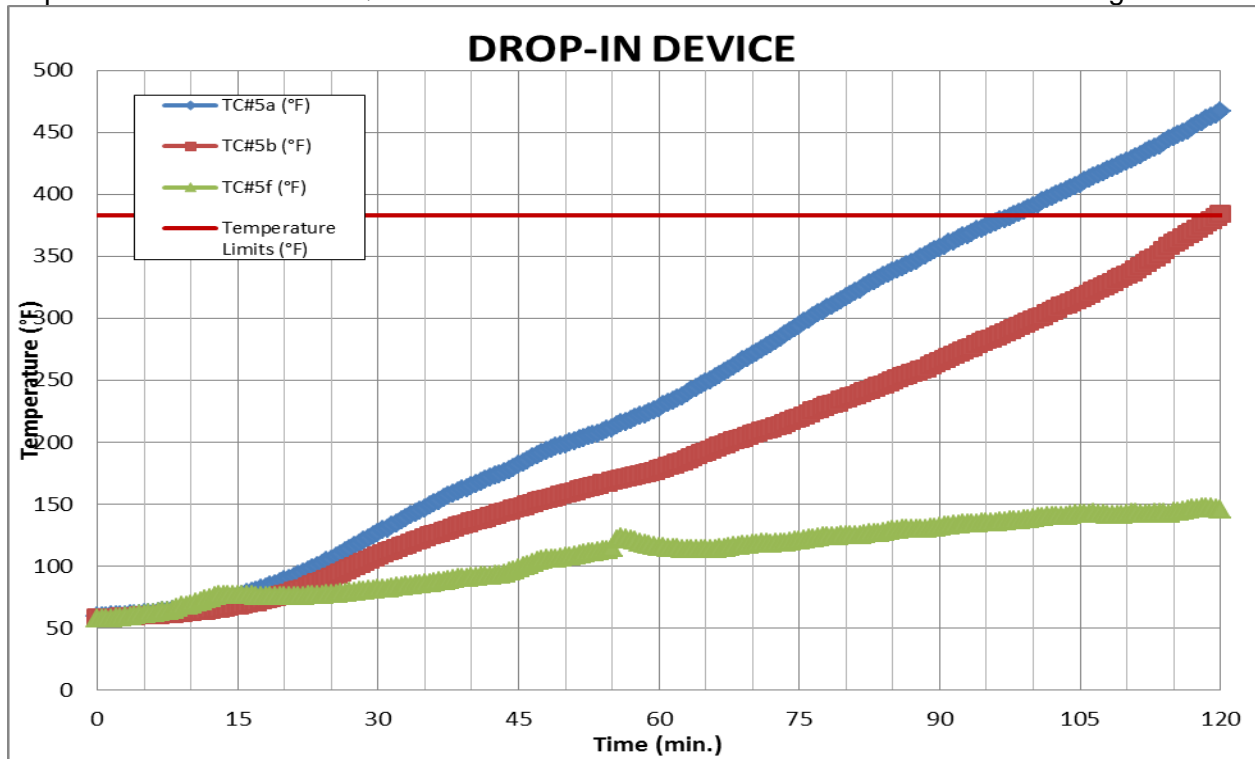

APPENDIX C

Photographs



Test Assembly No. 2 [5 – 5/32 in. (131mm) CLT Panel w/ 2 penetrations]





REVISION SUMMARY

DATE	PAGE(S)	SUMMARY
March 30, 2016	--	Issue date

Appendix B

Nordic X-Lam Product Information



Nordic X-Lam Nordic Structures

PR-L306

Revised March 26, 2016

Products: Nordic X-Lam
Nordic Structures
1100 Avenue des Canadiens-de-Montréal, Suite 504
Montreal, Québec, Canada H3B 2S2
(514) 871-8526
www.nordic.ca

1. Basis of the product report:
 - 2015 International Building Code (IBC): Section 2303.1.4 Structural Glued Cross-Laminated Timber
 - 2012 and 2009 IBC: Section 104.11 Alternative materials
 - 2015 International Residential Code (IRC): Sections R502.1.6, R602.1.6, and R802.1.6 Cross-Laminated Timber
 - 2012 and 2009 IRC: Section R104.11 Alternative materials
 - ANSI/APA PRG 320-2012 and PRG 320-2011 Performance Rated Cross-Laminated Timber
 - FPIInnovations Reports 201002775, 201004981, and 301010401, HPVA Report T-14054R, and other qualification data
2. Product description:

Nordic X-Lam cross-laminated timber (CLT) is manufactured with spruce-pine-fir in accordance with the E1 or custom grades of ANSI/APA PRG 320 through product qualification and/or mathematical models using principles of engineering mechanics. Nordic X-Lam panels can be used in floor, roof, and wall applications, and is manufactured in a plank billet with nominal widths of 12 to 96 inches, thicknesses of 3 to 15 inches, and lengths up to 64 feet.
3. Design properties:

Nordic X-Lam CLT shall be designed with the design properties and capacities provided in Tables 1 and 2, or with the allowable load table provided by the manufacturer (www.nordic.ca/en/documentation/technical-documents). The design adjustment factors, such as load duration, creep, moisture, temperature, volume factors, etc., shall be based on the recommendations provided by the manufacturer, the U.S. CLT Handbook (www.rethinkwood.com/mass-timber-webform/cross-laminated-timber-clt-handbook), and approved by the engineer of record. The lateral resistance of Nordic X-Lam CLT, when used as shearwalls or diaphragms, depends on the panel-to-panel connection and anchorage designs, and shall be consulted with the CLT manufacturer and approved by the engineer of record.
4. Product installation:

Nordic X-Lam CLT shall be installed in accordance with the recommendations provided by the manufacturer (see link above) and the engineering drawing approved by the engineer of record. Permissible details shall be in accordance with the engineering drawing.
5. Fire-rated assemblies:

Fire-rated assemblies shall be constructed in accordance with the recommendations provided by the manufacturer (see link above). Procedures specified in Chapter 16 of the 2015 National Design Specification for Wood Construction (NDS) shall be permitted for use in designing Nordic X-Lam CLT for a fire exposure up to 2 hours.

Nordic X-Lam CLT has been tested in accordance with ASTM E84, and meets the flame-spread index of 26 – 75 and smoke-developed index of 0 – 450.

6. Limitations:

- a) Nordic X-Lam CLT shall be designed in accordance with principles of mechanics using the design properties specified in this report or provided by the manufacturer.
- b) Nordic X-Lam products shall be limited to dry service conditions where the average equilibrium moisture content of solid-sawn lumber is less than 16 percent.
- c) Design properties for Nordic X-Lam CLT, when used as beams or lintels with loads applied parallel to the face-bond gluelines, are beyond the scope of this report.
- d) Nordic X-Lam CLT shall be manufactured in accordance with layup combinations specified in ANSI/APA PRG 320 or proprietary Nordic X-Lam CLT manufacturing specifications documented in the in-plant manufacturing standard approved by APA.
- e) Nordic X-Lam CLT is produced at the Nordic Structures, Chibougamau, Quebec facilities under a quality assurance program audited by APA.
- f) This report is subject to re-examination in one year.

7. Identification:

Nordic X-Lam CLT described in this report is identified by a label bearing the manufacturer's name (Nordic Structures) and/or trademark, the APA assigned plant number (1112), the product standard (ANSI/APA PRG 320), the APA logo, the CLT grade (such as E1), the report number PR-L306, and a means of identifying the date of manufacture.

Table 1. Allowable Design Properties^(a) for Lumber Laminations Used in Nordic X-Lam (for use in the U.S.)

CLT Grade	Major Strength Direction						Minor Strength Direction					
	F _{b,0} (psi)	E ₀ (10 ⁶ psi)	F _{t,0} (psi)	F _{c,0} (psi)	F _{v,0} (psi)	F _{s,0} (psi)	F _{b,90} (psi)	E ₉₀ (10 ⁶ psi)	F _{t,90} (psi)	F _{c,90} (psi)	F _{v,90} (psi)	F _{s,90} (psi)
E1	1,950	1.7	1,375	1,800	135	45	500	1.2	250	650	135	45

For SI: 1 psi = 0.006895 MPa

^(a) Tabulated values are allowable design values and not permitted to be increased for the lumber size adjustment factor in accordance with the NDS. The design values shall be used in conjunction with the section properties provided by the CLT manufacturer based on the actual layup used in manufacturing the CLT panel (see Table 2).

Table 2. Allowable Bending Capacities^(a) for Nordic X-Lam Listed in Table 1 (for use in the U.S.)

CLT Grade ^(b)	Layup # ^(c)	Thick-ness (in.)	Lamination Thickness (in.) in CLT Layup						Major Strength Direction						Minor Strength Direction					
			=	⊥	=	⊥	=	⊥	F _{S,ref0} (lb-ft/ft)	E _{I,ref0} (10 ⁶ lb-ft ² /ft)	G _{A,ref0} (10 ⁶ lb/ft)	V _{s,0} (lb/ft)	G _{k,u,0} ^(d) (10 ⁶ lb/ft)	F _{S,ref90} (lb-ft/ft)	E _{I,ref90} (10 ⁶ lb-ft ² /ft)	G _{A,ref90} (10 ⁶ lb/ft)	V _{s,90} (lb/ft)	G _{k,u,90} ^(d) (10 ⁶ lb/ft)		
E1	78-3s	3 1/8	1 1/64	1 1/16	1 1/64			2,525	48	0.34	1,070	1.36	95	1.4	0.47	360	1.36			
	105-3s	4 1/8	1 3/8	1 3/8	1 3/8			4,525	115	0.46	1,430	1.79	160	3.1	0.61	495	1.79			
	131-5s	5 1/8	1 1/64	1 1/16	1 1/64			5,800	184	0.69	1,470	2.23	785	35	0.94	1,090	2.23			
	175-5s	6 7/8	1 3/8	1 3/8	1 3/8			10,400	440	0.92	1,970	2.99	1,370	81	1.2	1,430	2.99			
	220-7s	8 5/8	1 3/8	1 1/16	1 3/8			15,975	853	1.4	2,400	3.75	2,160	184	1.5	1,580	3.75			
244-7l	9 5/8	1 3/8x2	1 3/8	1 3/8			23,700	1,404	2.0	3,200	4.18	1,370	81	1.9	1,430	4.18				
314-9l	12 3/8	1 3/8x2	1 3/8	1 3/8			36,700	2,794	2.4	3,875	5.38	3,125	309	2.5	1,960	5.38				

For SI: 1 in. = 25.4 mm; 1 ft = 304.8 mm; 1 lbf = 4.448N

- ^(a) Tabulated values are allowable design values and not permitted to be increased for the lumber size adjustment factor in accordance with the NDS.
- ^(b) The CLT grades are developed based on ANSI/APA PRG 320, as permitted by the standard.
- ^(c) The layup designation refers to the panel thickness (expressed in mm), the number of layers, and the layup combination ("s" for standard perpendicular layers, and "l" for doubled outermost parallel layers).
- ^(d) G_v = 36,200 psi based on product performance testing.

APA – The Engineered Wood Association is an approved national standards developer accredited by American National Standards Institute (ANSI). APA publishes ANSI standards and Voluntary Product Standards for wood structural panels and engineered wood products. APA is an accredited certification body under ISO/IEC 17065 by Standards Council of Canada (SCC), an accredited inspection agency under ISO/IEC 17020 by International Code Council (ICC) International Accreditation Service (IAS), and an accredited testing organization under ISO/IEC 17025 by IAS. APA is also an approved Product Certification Agency, Testing Laboratory, Quality Assurance Entity, and Validation Entity by the State of Florida, and an approved testing laboratory by City of Los Angeles.

**APA – THE ENGINEERED WOOD ASSOCIATION
HEADQUARTERS**

7011 So. 19th St. • Tacoma, Washington 98466
Phone: (253) 565-6600 • Fax: (253) 565-7265 • Internet Address: www.apawood.org

PRODUCT SUPPORT HELP DESK
(253) 620-7400 • E-mail Address: help@apawood.org

DISCLAIMER

APA Product Report® is a trademark of *APA – The Engineered Wood Association*, Tacoma, Washington. The information contained herein is based on the product evaluation in accordance with the references noted in this report. Neither APA, nor its members make any warranty, expressed or implied, or assume any legal liability or responsibility for the use, application of, and/or reference to opinions, findings, conclusions, or recommendations included in this report. Consult your local jurisdiction or design professional to assure compliance with code, construction, and performance requirements. Because APA has no control over quality of workmanship or the conditions under which engineered wood products are used, it cannot accept responsibility for product performance or designs as actually constructed.



Nordic X-Lam Nordic Engineered Wood

PR-L306C

Revised September 23, 2015

Products: Nordic X-Lam
Nordic Engineered Wood
1100 Avenue des Canadiens-de-Montréal, Suite 504
Montreal, Québec, Canada H3B 2S2
(514) 871-8526
www.nordicewp.com

1. Basis of the product report:
 - 2010 National Building Code of Canada (NBCC): Clause 1.2.1.1 of Division A and Clauses 4.1, 4.3.1.1, and 9.23 of Division B
 - CAN/CSA O86-14 Engineering Design in Wood
 - ANSI/APA PRG 320-2012 and PRG 320-2011 Performance Rated Cross-Laminated Timber
 - FPInnovations Reports 201002775, 201004981, and 301010401, and other qualification data
2. Product description:

Nordic X-Lam cross-laminated timber (CLT) is manufactured with spruce-pine-fir in accordance with the E1 grade of ANSI/APA PRG 320 or proprietary layup combinations approved by APA through product qualification and/or mathematical models using principles of engineering mechanics. Nordic X-Lam can be used in floor, roof, and wall applications, and is manufactured in a plank billet with nominal widths of 305 to 2438 mm (12 to 96 inches), thicknesses of 76 to 381 mm (3 to 15 inches), and lengths up to 19.5 m (64 feet).
3. Design properties:

Nordic X-Lam CLT shall be designed with the design properties and capacities provided in Tables 1 and 2, or with the maximum load table provided by the manufacturer (www.nordic.ca/en/documentation/technical-documents). The design adjustment factors, such as load duration, creep, moisture, temperature, volume factors, etc., shall be based on the recommendations provided by the manufacturer, the Canadian CLT Handbook (www.masstimer.com/products/cross-laminated-timber-clt/handbook/modules), and approved by the engineer of record. The lateral resistance of Nordic X-Lam CLT, when used as shearwalls or diaphragms, depends on the panel-to-panel connection and anchorage designs, and shall be consulted with the CLT manufacturer and approved by the engineer of record.
4. Product installation:

Nordic X-Lam CLT shall be installed in accordance with the recommendations provided by the manufacturer (see link above) and the engineering drawing approved by the engineer of record. Permissible details shall be in accordance with the engineering drawing.
5. Fire-rated assemblies:

Fire-rated assemblies shall be constructed in accordance with the recommendations provided by the manufacturer (see link above). Procedures specified in Chapter 8 of the 2011 Canadian Cross-Laminated Timber Handbook (www.fpinnovations.ca/Pages/CltForm.aspx) may be used in the fire design of Nordic X-Lam CLT when approved by the authority having jurisdiction.

Nordic X-Lam CLT has been tested in accordance with CAN/ULC S102-10, and meets the flame-spread rating of 26 – 75 and smoke developed classification of 0 – 450.

6. Limitations:

- a) Nordic X-Lam CLT shall be designed in accordance with principles of mechanics using the design properties specified in this report or provided by the manufacturer.
- b) Nordic X-Lam products shall be limited to dry service conditions where the average equilibrium moisture content of solid-sawn lumber is less than 16 percent.
- c) Design properties for Nordic X-Lam CLT, when used as beams or lintels with loads applied parallel to the face-bond gluelines, are beyond the scope of this report.
- d) Nordic X-Lam CLT shall be manufactured in accordance with layup combinations specified in ANSI/APA PRG 320 or proprietary Nordic X-Lam CLT manufacturing specifications documented in the in-plant manufacturing standard approved by APA.
- e) Nordic X-Lam CLT is produced at the Nordic Engineered Wood, Chibougamau, Quebec facilities under a quality assurance program audited by APA.
- f) This report is subject to re-examination in one year.

7. Identification:

Nordic X-Lam CLT described in this report is identified by a label bearing the manufacturer's name (Nordic Engineered Wood) and/or trademark, the APA assigned plant number (1112), the product standard (ANSI/APA PRG 320), the APA logo, the CLT grade (such as E1), the report number PR-L306, and a means of identifying the date of manufacture.

Table 1. Specified Strengths and Modulus of Elasticity^(a) for Laminations Used in Nordic X-Lam (for Use in Canada)

CLT Grade	Major Strength Direction						Minor Strength Direction					
	$f_{b,0}$ (MPa)	E_0 (MPa)	$f_{t,0}$ (MPa)	$f_{c,0}$ (MPa)	$f_{v,0}$ (MPa)	$f_{s,0}$ (MPa)	$f_{b,90}$ (MPa)	E_{90} (MPa)	$f_{t,90}$ (MPa)	$f_{c,90}$ (MPa)	$f_{v,90}$ (MPa)	$f_{s,90}$ (MPa)
E1	28.2	11,700	15.4	19.3	1.5	0.5	7.0	9,000	3.2	9.0	1.5	0.5

For Imperial: 1 MPa = 145.04 psi

^(a) Tabulated values are Limit States design values and not permitted to be increased for the lumber size adjustment factor in accordance with CSA O86. The design values shall be used in conjunction with the section properties provided by the CLT manufacturer based on the actual layup used in manufacturing the CLT panel (see Table 2).

Table 2. Unfactored Limit States Design Bending Resistances^(a) for Nordic X-Lam Listed in Table 1 (for Use in Canada)

CLT Grade ^(b)	Layup # ^(c)	Thick-ness (mm)	Lamination Thickness (mm) in CLT Layup						Major Strength Direction						Minor Strength Direction					
			=	⊥	=	⊥	=	⊥	$F_{b,ed,0}$ (10 ⁶ N-mm/m)	$E_{ed,0}$ (10 ⁹ N-mm ² /m)	$GA_{ed,0}$ (10 ⁶ N/m)	$V_{v,0}$ (kN/m)	$G_{k,0}$ (10 ⁶ N/m)	$F_{b,ed,90}$ (10 ⁶ N-mm/m)	$E_{ed,90}$ (10 ⁹ N-mm ² /m)	$GA_{ed,90}$ (10 ⁶ N/m)	$V_{v,90}$ (kN/m)	$G_{k,90}$ (10 ⁶ N/m)		
E1	78-3s	78	25.8	26.8	25.8			24	452	5.4	25	20	0.84	14	6.9	9.0	20			
	105-3s	105	34.9	34.9	34.9			42	1,081	7.3	34	26	1.40	32	9.0	12	26			
	131-5s	131	25.8	26.8	25.8		25.8	54	1,735	11	35	33	7.1	363	14	26	33			
	175-5s	175	34.9	34.9	34.9		34.9	97	4,140	15	46	44	12	831	18	34	44			
	220-7s	220	34.9	26.8	34.9		26.8	149	8,019	22	57	55	19	1,884	22	37	55			
	244-7i	244	2 x 34.9	34.9	34.9		2 x 34.9	221	13,194	31	75	61	12	831	28	34	61			
	314-9i	314	2 x 34.9	34.9	34.9		34.9	342	26,272	37	91	79	28	3,163	37	46	79			

For Imperial: 1 mm = 0.0394 in.; 1 m = 3.28 ft; 1 N = 0.2248 lbf

- ^(a) Tabulated values are unfactored Limit States design values and not permitted to be increased for the lumber size adjustment factor in accordance with CSA O86.
- ^(b) The CLT grades are developed based on ANSI/APA PRG 320, as permitted by the standard.
- ^(c) The layup designation refers to the panel thickness (in mm), the number of layers, and the layup combination ("s" for standard perpendicular layers, and "i" for doubled outermost parallel layers).

APA – The Engineered Wood Association is an approved national standards developer accredited by American National Standards Institute (ANSI). APA publishes ANSI standards and Voluntary Product Standards for wood structural panels and engineered wood products. APA is an accredited certification body under ISO/IEC 17065 by Standards Council of Canada (SCC), an accredited inspection agency under ISO/IEC 17020 by International Code Council (ICC) International Accreditation Service (IAS), and an accredited testing organization under ISO/IEC 17025 by IAS. APA is also an approved Product Certification Agency, Testing Laboratory, Quality Assurance Entity, and Validation Entity by the State of Florida, and an approved testing laboratory by City of Los Angeles and Miami-Dade County.

**APA – THE ENGINEERED WOOD ASSOCIATION
HEADQUARTERS**

7011 So. 19th St. • Tacoma, Washington 98466
Phone: (253) 565-6600 • Fax: (253) 565-7265 • Internet Address: www.apawood.org

PRODUCT SUPPORT HELP DESK
(253) 620-7400 • E-mail Address: help@apawood.org

DISCLAIMER

APA Product Report® is a trademark of *APA – The Engineered Wood Association*, Tacoma, Washington. The information contained herein is based on the product evaluation in accordance with the references noted in this report. Neither APA, nor its members make any warranty, expressed or implied, or assume any legal liability or responsibility for the use, application of, and/or reference to opinions, findings, conclusions, or recommendations included in this report. Consult your local jurisdiction or design professional to assure compliance with code, construction, and performance requirements. Because APA has no control over quality of workmanship or the conditions under which engineered wood products are used, it cannot accept responsibility for product performance or designs as actually constructed.

Appendix C

Fire Stops and Sealing Joints in Cross-laminated
Timber Construction, May 12, 2014, FPInnovations

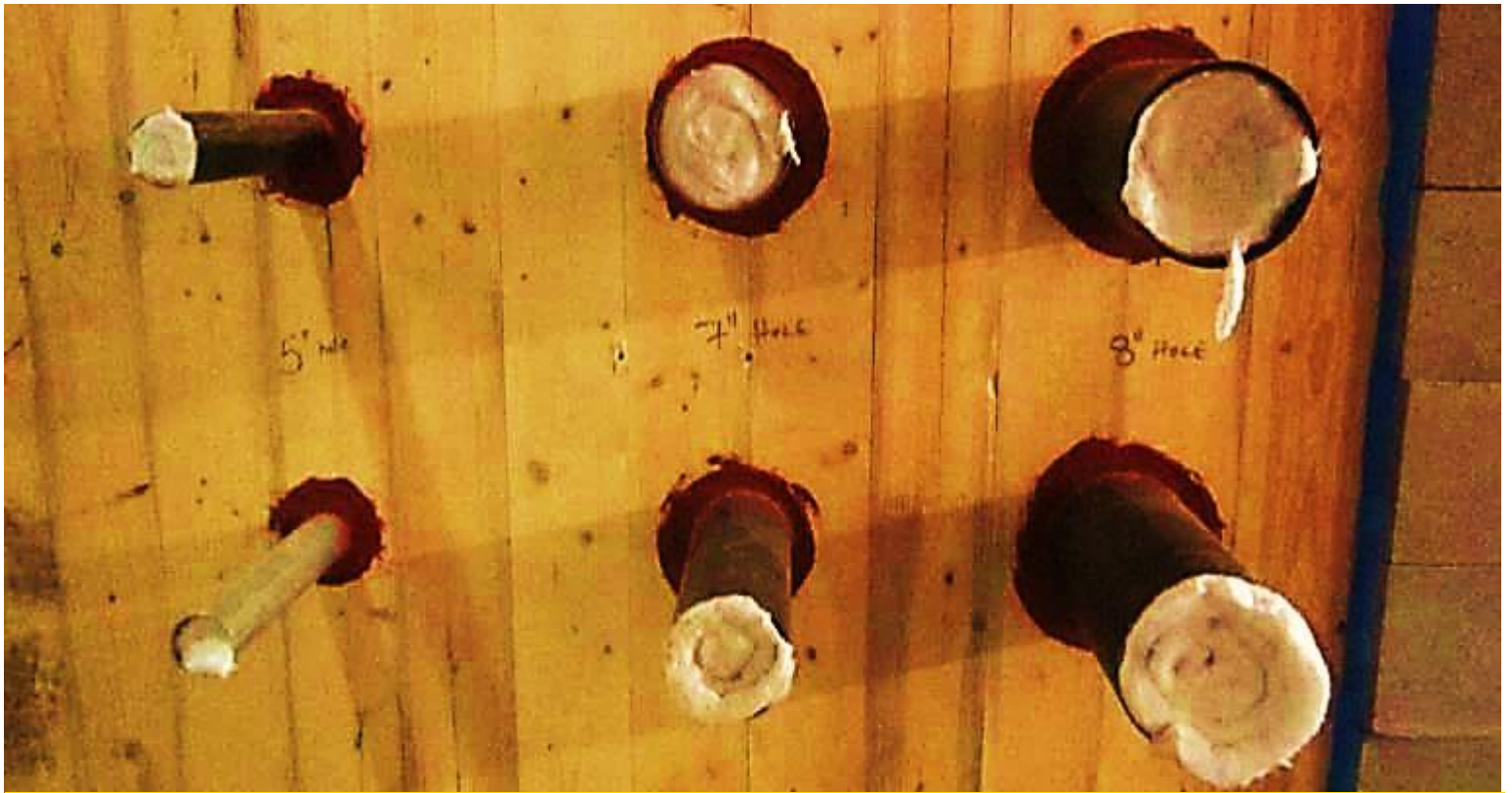

Fire Stops and Sealing Joints in Cross-laminated Timber Construction

Date: May 12, 2014

By: Christian Dagenais, Eng., M.Sc., Advanced Building Systems

Natural Resources Canada
Canadian Forest Service

Ressources Naturelles Canada
Service Canadien des Forêts

REPORT APPROVAL FORM

TYPE OF REPORT Canadian Forest Service

PROJECT # : 301006715

TITLE : Fire Stops and Sealing Joints in Cross-laminated Timber Construction

COMPANY : Canadian Forest Service

DATE : May 12, 2014

REVIEWERS : Lindsay Osborne, M.A.Sc.

Sylvain Gagnon, Eng.

Andrew Harmsworth, M. Eng., P.Eng., GHL Consultants Ltd.

SIGNATURES

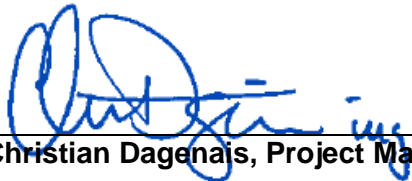

Christian Dagenais, Project Manager

Date : May 12, 2014



Sylvain Gagnon, Reviewer

Date : May 12, 2014

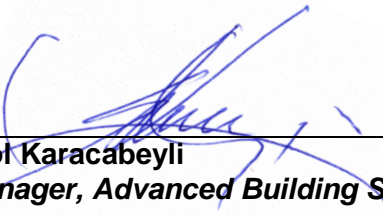

Erol Karacabeyli
Manager, Advanced Building Systems Dept.

Date : May 12, 2014

FPInnovations is a not-for-profit world leader that specializes in the creation of scientific solutions in support of the Canadian forest sector's global competitiveness and responds to the priority needs of its industry members and government partners. It is ideally positioned to perform research, innovate, and deliver state-of-the-art solutions for every area of the sector's value chain, from forest operations to consumer and industrial products. FPInnovations' staff numbers more than 525. Its R&D laboratories are located in Québec City, Ottawa, Montréal, Thunder Bay, Edmonton and Vancouver, and it has technology transfer offices across Canada. For more information about FPInnovations, visit: www.fpinnovations.ca.

Follow us on:  

PROJECT N^o 301006715

Fire Stops and Sealing Joints in Cross-laminated Timber Construction

ACKNOWLEDGEMENTS

This project was financially supported by the Canadian Forest Service under the Contribution Agreement existing between the Government of Canada and FPInnovations. The funding from the Province of British Columbia - Ministry of Technology, Innovation and Citizens' Services is also acknowledged.

The author would also like to thank Marc Narduzzi from PCL Construction, as well as Andrew Harmsworth and Jun H. Kim from GHL Consultants Ltd. for providing valuable comments and assistance throughout this project.

The picture of the cover page is provided by Intertek Testing Services NA Ltd., while others shown in the report are provided by GHL Consultants Ltd.

REVIEWERS

Lindsay Osborne, M.A.Sc., Scientist
Sylvain Gagnon, Eng., Research Leader
Advanced Building Systems, FPInnovations

Andrew Harmsworth, M.Eng, P.Eng.
GHL Consultants Ltd.

PROJECT LEADER

Christian Dagenais, Eng., M.Sc.
Advanced Building Systems
Telephone: (418) 659-2647 ext. 6753

christian.dagenais@fpinnovations.ca

TABLE OF CONTENTS

List of Figures	v
List of Tables	v
1 OBJECTIVE.....	1
2 STAFF	1
3 BACKGROUND.....	1
3.1 National Building Code of Canada.....	1
3.1.1 Joint Fire Stop	2
3.1.2 Through-Penetration Fire Stop	2
3.2 CAN/ULC S115 Test Method.....	3
4 MATERIALS AND METHODS	3
4.1 Horizontal Fire Stop (Floor-to-Wall No.1).....	3
4.2 Horizontal Fire Stop (Floor-to-Wall No.2).....	4
4.3 Horizontal Fire Stop (Wall-to-Floor)	5
4.4 Horizontal Fire Stop (Floor-to-fFloor)	7
4.5 Horizontal Fire Stop (Stair landings)	8
4.6 Through-Penetration Fire Stops.....	8
5 RESULTS.....	10
5.1 Horizontal Fire Stop (Floor-to-Wall No.1).....	10
5.2 Horizontal Fire Stop (Floor-to-Wall No.2).....	11
5.3 Horizontal Fire Stop (Wall-to-Floor)	12
5.4 Horizontal Fire Stop (Floor-to-Floor)	14
5.5 Horizontal Fire Stop (Stair landings)	14
5.6 Through-Penetration Fire Stops.....	15
6 DISCUSSION AND RECOMMENDATIONS	17
7 CONCLUSION.....	18
8 REFERENCES	20
Appendix I.....	21
Appendix II.....	38
Appendix III.....	55
Appendix IV	72
Appendix V	91
Appendix VI	111

List of Figures

Figure 1.	Horizontal linear joint No. 1 (Floor-to-Wall)	4
Figure 2.	Horizontal linear joint No. 2 (Floor-to-Wall)	5
Figure 3.	Horizontal linear joint No. 3 (Wall-to-Floor)	6
Figure 4.	Thermocouple locations for linear joint No. 3 (Wall-to-Floor).....	6
Figure 5.	Horizontal linear joint No. 4 (Floor-to-Floor)	7
Figure 6.	Horizontal linear joint No. 5 (Stair landings)	8
Figure 7.	Through-penetration fire stops No. 6	9
Figure 8.	Test sample No.1 removed from furnace	11
Figure 9.	Time-temperature curve during test sample No.2	12
Figure 10.	Time-temperature curve during test sample No.3	13
Figure 11.	Visual observations from test sample No.3	13
Figure 12.	Test sample No.4 removed from furnace	14
Figure 13.	Visual observations from test sample No.5	15
Figure 14.	Unexposed surface of the 4 in. cast iron pipe during the test.....	16
Figure 15.	Test sample No.6 removed from furnace	16
Figure 16.	Joint fire stopping located at unexposed surface	17
Figure 17.	Fire stopping of through-penetrations	18

List of Tables

Table 1 – Fire protection rating of closures, per NBCC	2
Table 2 – Through-penetration test matrix for test sample No.6.....	9

1 OBJECTIVE

The main objective of this study is to evaluate the fire-protection F- and T-ratings of selected fire stops and sealing joints in cross-laminated timber assemblies, in accordance with CAN/ULC S115 test method, “*Standard Method of Fire-Tests of Firestop System*” [1].

Recommendations are given in this report with respect to proper detailing to ensure that the tested closure devices, when used in mass timber plate construction, will perform as expected. It is noted that test data is to date limited, and further testing may result in revision of these recommendations

2 STAFF

Christian Dagenais, Eng, M.Sc Scientist, Advanced Building Systems

Andrew Harmsworth, M.Eng, P.Eng. Principal, GHL Consultants Ltd.

Testing was witnessed by Andrew Harmsworth and Marc Narduzzi on behalf of FPInnovations. Most of the results and discussion presented herein are taken from a detailed test report written by Jun H. Kim and Andrew Harmsworth of GHL Consultants Ltd [2] and provided to FPInnovations.

3 BACKGROUND

A recent literature review – conducted by a CHM Fire Consultants on behalf of FPInnovations – identified that there are currently no listed fire stop systems available in North America for service penetrations in mass timber plate construction, such as CLT walls and floors, thus increasing the difficulty for designers in gaining acceptance of a proposed design from an Authority Having Jurisdiction (AHJ) [3].

The CHM literature review provides background information on the CAN/ULC S115 test method, on the technical provisions in the National Building Code of Canada [4, 5] and recent work done in Europe on fire stopping of through-penetrations on solid wood assemblies.

3.1 National Building Code of Canada

The National Building Code of Canada (NBCC) requires that buildings be subdivided into fire-rated compartments in order to limit the risk of fire spread beyond the compartment of fire origin. In order to effectively provide fire-rated boundaries to a compartment, these boundaries need to be built as fire separations.

Walls, partitions, and floors required to be designed as fire separations, need to be constructed as to provide a continuous element and to have a prescribed fire-resistance rating. Service penetrations and gaps in fire separations are inevitable. In order to maintain the integrity of fire separations with service penetrations and gaps, these details must maintain their integrity and fire-resistance. Furthermore, smoke-tight joints must be provided where fire separations abut on or intersect a floor, a wall or a roof. Subsections 3.1.8 and 3.1.9 of Division B of the NBCC detail the specific provisions for enclosures and penetrations in fire-rated separations.

Penetrations for building service equipment and systems in wall and floor assemblies acting as fire separations must be planned early in the designing stage. As designers embrace taller and larger wood buildings, and as new mass timber plate systems such as cross-laminated timber (CLT) become available, proper design solutions with respect to fire stopping in mass timber construction become increasingly necessary.

Fire stop systems are intended to ensure the integrity of a fire compartment by maintaining the fire-resistance rating of the floor and/or wall assemblies that they penetrate, or at construction joints. According to CAN/ULC S115, a fire stop (also called fire stop system) consists of a material, component and means of support used to fill gaps between fire separations or between fire separations and other assemblies, or used around items that wholly or partially penetrate a fire separation. A fire stop that provides a seal along a continuous linear opening between two (2) assemblies is required to provide a fire-resistance rating, or bounded by a fire-resistance rated assembly, to prevent the spread of fire is called “*joint fire stop system*”. In the case where a fire stop seals an opening around penetrating items, such as cables, cable trays, conduits, ducts and pipes, which pass through the entire assembly, such fire stop system is called “*through-penetration fire stop*”.

3.1.1 Joint Fire Stop

Subsection 3.1.8 of Division B of the NBCC requires that fire separation terminate so that smoke-tight joints are provided where it abuts on, or intersects a floor, a roof slab, or a roof deck. The continuity of a fire separation where it abuts against another fire separation, a floor, a ceiling, or an exterior wall assembly, is typically maintained by filling all openings at the juncture of the assemblies with a material that will ensure the integrity of the fire separation at that location for the full duration of the prescribed fire-resistance rating.

3.1.2 Through-Penetration Fire Stop

Subsection 3.1.9 of Division B of the NBCC prescribes penetrations of a fire separation or a membrane forming part of an assembly required to provide a fire-resistance rating to be sealed by a fire stop system that has been tested in accordance with CAN/ULC S115 or cast-in place devices. According to the NBCC, the use of the term “cast in place” is to reinforce that there are to be no gaps between the building service or penetrating item, and the membrane or assembly it penetrates, which is typically found in reinforced concrete slab or wall. A minimum F-rating not less than those shown in

Table 1 are to be provided by the closures used in the fire separation. A fire stop shall be considered as meeting the requirements for an F-rating if it remains in the opening during the fire test for the rating period without permitting the passage of flame through openings, or the occurrence of flaming on any element of the unexposed side of the fire stop system.

Table 1 – Fire protection rating of closures, per NBCC

Fire-Resistance Rating of Fire Separation	Minimum Fire-Protection Rating of Closure
45 min	45 min
1 h	45 min
1.5 h	1 h
2 h	1.5 h
3 h	2 h
4 h	3 h

Additional requirements may be applicable and need to be fulfilled per the NBCC, such as where a fire stop is required to provide a FT-rating not less than the fire-resistance rating for the fire separation of the assembly. A FT-rating is considered to be met when a fire stop remains in the opening during the fire test while achieving the requirements for a F-rating and limiting the temperature rise below 180°C above the initial temperature, when measured on the unexposed surface of the fire stop system.

3.2 CAN/ULC S115 Test Method

The Canadian test method references in the NBCC is intended to evaluate the fire performance of fire stop systems used in assemblies, or membranes forming part of an assembly, required to provide a fire-resistance rating as well as linear openings (i.e. construction joints) between adjacent fire-resistance rated floor assemblies, wall assemblies, or both.

When evaluating through-penetration fire stops, the construction of the test specimens needs to include any penetrating elements (pipes, ducts, conduits, cables, etc.) so as to produce a truly representative fire stop system for which an evaluation is being sought. Through-penetrating elements are to be installed such as they extend 305 mm (12 in.) beyond the faces of the surrounding walls or floor construction on the exposed side.

Typically, manufacturers of fire stop systems publish technical documentation through their website. Additional information such as construction details and appropriate ratings may also be found on websites of accredited agencies such as Intertek Testing Services or Underwriters Laboratories (UL). However, as reported in [3], there are currently no listed fire stop systems available for service penetrations and construction joints in solid wood wall and floor assemblies in North America.

4 MATERIALS AND METHODS

The tested specimens were subjected to CAN/ULC S115, “*Standard Method of Fire-Tests of Firestop System*” [1], to evaluate their fire-protection F- and T-ratings, as required by the NBCC. All specimens used in this test series were built from V2 stress grade CLT panels manufactured with Spruce-Pine-Fir (SPF) lumber and structural adhesive conforming to ANSI/APA PRG-320 standard [6].

These tests were all conducted at the Intertek Evaluation Center in Coquitlam, BC.

In attempting to evaluate selected commercially available joint fire stop systems and configurations, a total of five (5) CLT assemblies with linear openings (construction joints) and one (1) CLT assembly having six (6) through-penetrations have been evaluated.

4.1 Horizontal Fire Stop (Floor-to-Wall No.1)

The first assembly consisted of a 5-ply CLT wall (169 mm thick) measuring 2.13 m wide by 2.28 m high, and a 3-ply CLT floor (99 mm thick) measuring 2.13 m wide by 1.16 m long. A linear opening (gap) of 13 mm (½ in.) was created between the CLT wall and floor elements. The entire assembly was fastened together using 254 mm lag screws. Such joint would typically occur where a fire-resistance rated floor assembly abuts against a fire-resistance rated wall assembly, such as at elevator and stair shafts.

The CLT floor-to-wall linear joint was fire stopped on the unexposed side of the joint using Hilti’s CP 606 FS (Red) joint filler to a depth of 25 mm deep into the gap. It is noted that, according to UL System No. XHBN.FW-D-0041, Hilti CP 606 FS (Red) is approved for F- and FT-ratings of 2 hours in floor-to-wall concrete assemblies with a maximum joint width of 13 mm (½”). The joint system is designed to accommodate a maximum of 12.5% compression or extension and requires using a minimum of 25 mm of fill material to be applied within the joint to prevent movement of flames at the intersection between fire-resistance rated assemblies.

Although Figure 1 shows that both sides of the linear joint had joint filler, the filler on the fire exposed side was actually removed prior to testing, leaving CP 606 FS (Red) joint filler only on the unexposed side (i.e. at the top of the linear joint). The first assembly was evaluated in the morning of October 22, 2013.

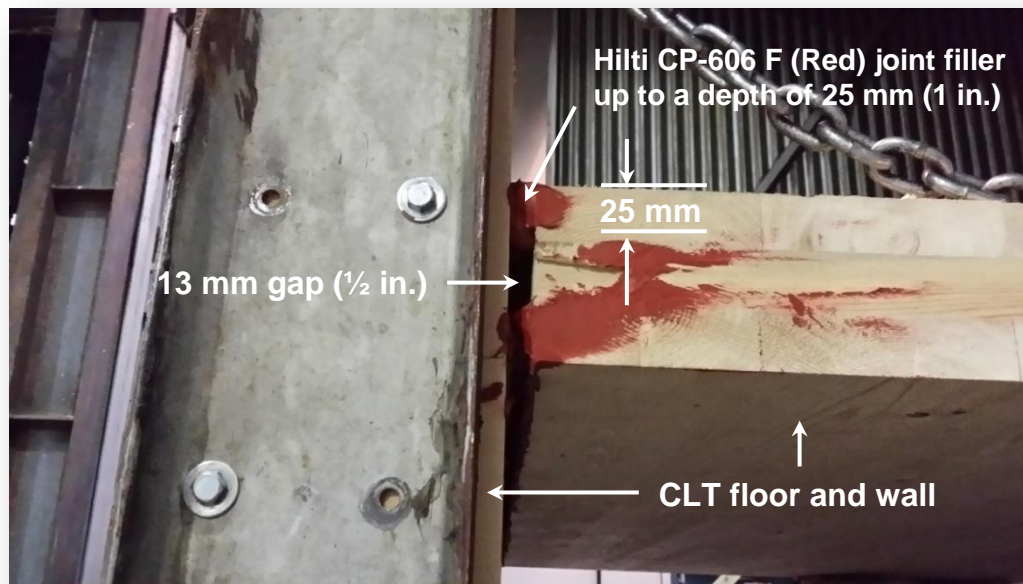

Figure 1. Horizontal linear joint No. 1 (Floor-to-Wall)

Unexposed surface thermocouples, as required by CAN/ULC S115, were mounted on the unexposed surface to determine eligibility for T-ratings. Details and pictures of the thermocouple locations can be found in the laboratory test report [7].

4.2 Horizontal Fire Stop (Floor-to-Wall No.2)

The second assembly was identical to the first assembly with the exception that the Hilti CP 606 FS (Red) joint filler was applied only on the fire-exposed side, to a depth of 25 mm into a linear opening (gap) of 13 mm (1/2 in), as shown in Figure 2. Such joint would typically occur where a fire-resistance rated floor assembly abuts against a fire-resistance rated wall assembly, such as at elevator and stair shafts.

The second assembly was evaluated in the afternoon of October 22, 2013.

Unexposed surface thermocouples, as required by CAN/ULC S115, were mounted on the unexposed surface to determine eligibility for T-ratings. Details and pictures of the thermocouple locations can be found in the laboratory test report [8].

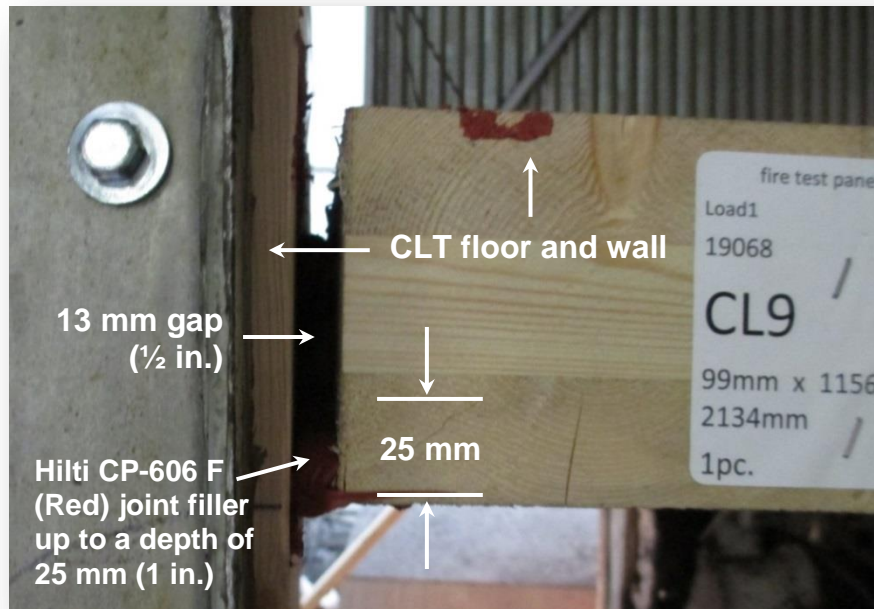

Figure 2. Horizontal linear joint No. 2 (Floor-to-Wall)

4.3 Horizontal Fire Stop (Wall-to-Floor)

The third assembly consisted of a 5-ply CLT wall (169 mm thick) measuring 2.13 m wide by 1.86 m high, and a 3-ply CLT floor (99 mm thick) measuring 2.13 m wide by 1.65 m long. A linear opening (gap) of 13 mm (½ in.) was created between the CLT wall and floor elements. The entire assembly was fastened together using 254 mm lag screws. Such joint would typically occur where a fire-resistance rated wall assembly abuts to the underside of a fire-resistance rated floor assembly, such as when using fire-rated partitions within a floor area to enclose a fire compartment in buildings.

The CLT wall-to-floor linear joint was fire stopped on both sides of the joint using Hilti's CP 606 FS (Red) joint filler to a depth of 25 mm deep into the gap, as shown in Figure 3. The third assembly was evaluated in the morning of October 24, 2013.

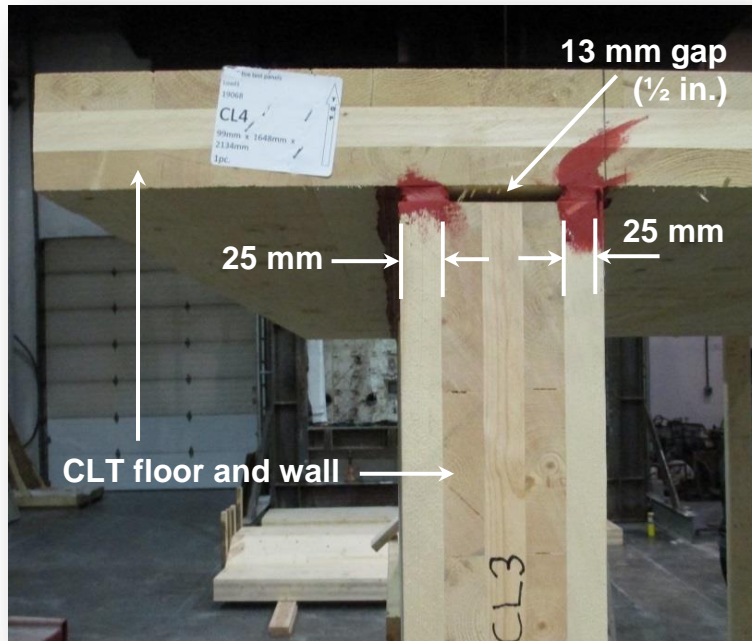

Figure 3. Horizontal linear joint No. 3 (Wall-to-Floor)

Unexposed surface thermocouples, as required by CAN/ULC S115, were mounted on the unexposed surface to determine eligibility for T-ratings. Details and pictures of the thermocouple locations can be found in the laboratory test report [9]. Figure 4 shows the thermocouple locations on the unexposed side, along the joint filler.



Figure 4. Thermocouple locations for linear joint No. 3 (Wall-to-Floor)

4.4 Horizontal Fire Stop (Floor-to-Floor)

The fourth assembly consisted of a 3-ply CLT floor slab (99 mm thick) measuring 0.7 m wide by 2.13 m long, supported by 5-ply CLT floor slabs (169 mm thick) of similar dimensions as the 3-ply. The entire assembly was fastened together using 152 mm (6 in.) lag screws. There was no discernable gap between the 5-ply floor slabs and the 3-ply transition. The “corrugated” floor system consisted of staggered CLT floor slabs is a useful configuration for the distribution of mechanical and electrical systems. The use of such configuration creates horizontal chases between the staggered floor slabs to allow running the services both below the floor and above the ceiling. The chases may then be left exposed or enclosed, depending in the architectural design and code-related fire provisions (e.g. flame spread of concealed spaces, sprinklers, etc.).

The CLT floor-to-floor linear joints were fire stopped on the exposed side of the joints using Hannoband BSB BG1 fire protection tape on one side and Manus Bond SIP-seal VLM sealant on the other side. Hannoband BSB BG1 fire protection tape is a polyurethane soft foam with an acrylate dispersion impregnation which is especially formulated for fire protection and currently evaluated only to European standards. The Hannoband tape is suitable for the forming of joints between masonry elements and suitable for a F-rating up to 2 hours for partitions. Manus Bond SIP-seal VLM is a high performance elastomeric adhesive/sealant used, among other others, in the Structural Insulated Panels (SIP) industry. The fourth assembly was evaluated in the morning of October 23, 2013.

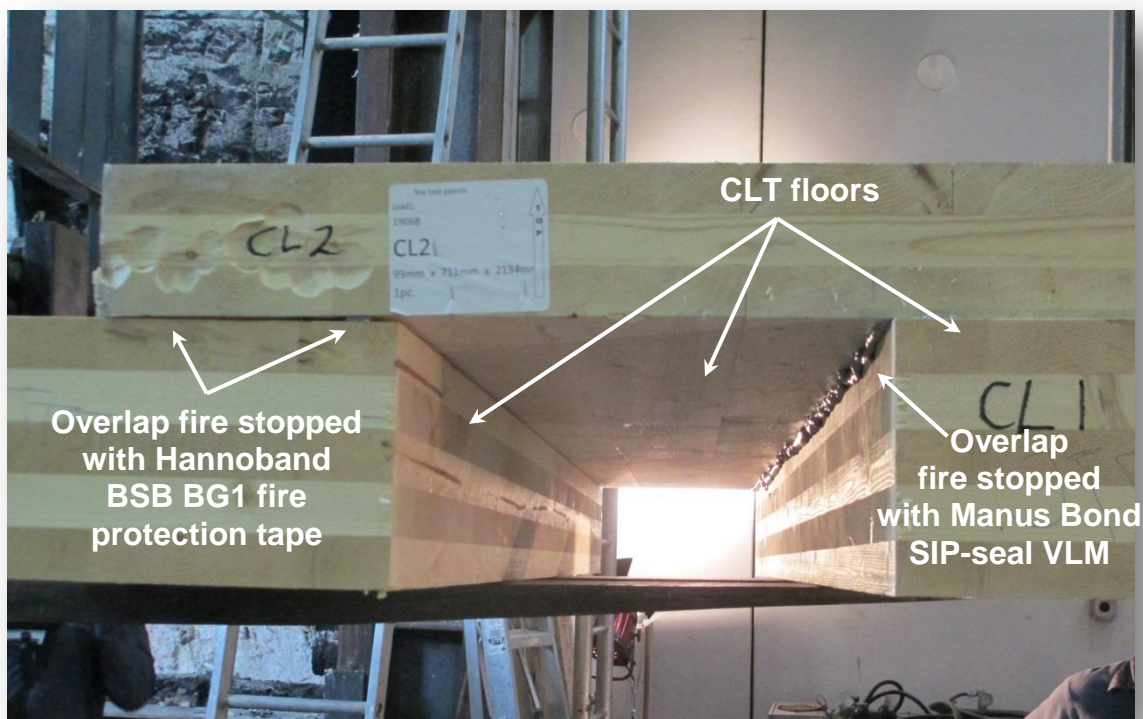

Figure 5. Horizontal linear joint No. 4 (Floor-to-Floor)

Unexposed surface thermocouples, as required by CAN/ULC S115, were mounted on the unexposed surface to determine eligibility for T-ratings. Details and pictures of the thermocouple locations can be found in the laboratory test report [10].

4.5 Horizontal Fire Stop (Stair landings)

The fifth assembly consisted of 5-ply CLT floor slabs (169 mm thick) measuring 0.7 m wide by 2.13 m long, supported by 5-ply CLT floor slabs (169 mm thick) of similar dimensions as the 3-ply. The entire assembly was fastened together using 152 mm (6 in.) lag screws. Such joints would typically occur with fire-resistance rated stair assemblies, such as those used as exit stairs required to have smoke-tight fire separation and a fire-resistance rating.

The CLT stair assembly linear joints were fire stopped using Hannoband BSB BG1 fire protection tape placed into a groove machined on the side of the upper CLT landing and the stair ramp and Manus Bond SIP-seal VLM sealant installed at the half-lapped joint machined at the junction between the lower CLT landing and the stair ramp (Figure 6). The fifth assembly was evaluated in the afternoon of October 23, 2013.

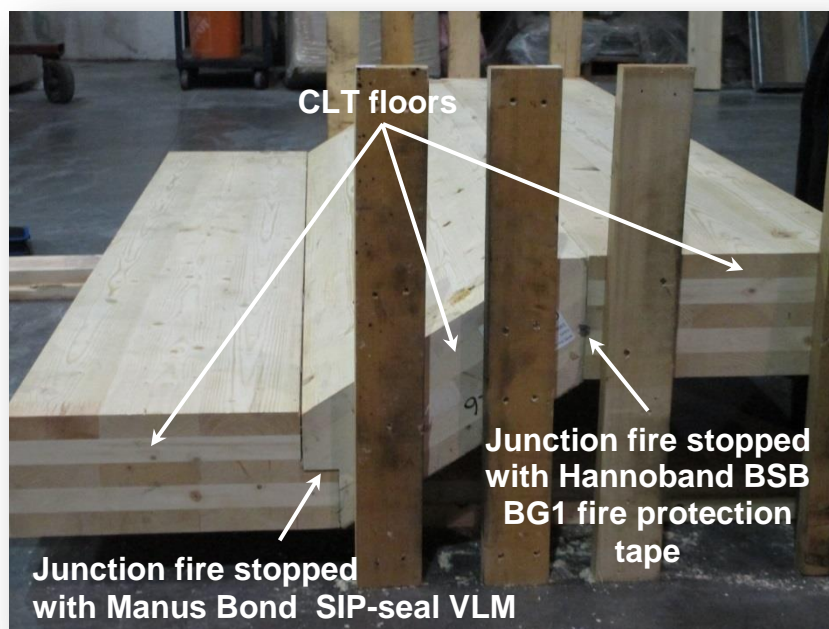

Figure 6. Horizontal linear joint No. 5 (Stair landings)

Unexposed surface thermocouples, as required by CAN/ULC S115, were mounted on the unexposed surface to determine eligibility for T-ratings. Details and pictures of the thermocouple locations can be found in the laboratory test report [11].

4.6 Through-Penetration Fire Stops

The sixth assembly consisted of 3-ply CLT vertical slab (99 mm thick) measuring 1.52 m wide by 1.37 m high, with a total of six (6) round holes cut through the CLT, as shown in Figure 7. Two of each hole were cut and measured 127, 178 and 203 mm in diameters (5, 7 and 8 in.). The holes contained pipes penetrations as detailed in Table 2. The pipes were centered within the holes, thus not touching the CLT slab. Through-openings in fire separations are inherent to every types of construction and needs to be properly protected by means conforming to the provisions detailed in Subsection 3.1.8 of Division B of the NBCC.



a) Unexposed side



b) Exposed side

Figure 7. Through-penetration fire stops No. 6

Table 2 – Through-penetration test matrix for test sample No.6

Sample	Opening	Penetrating Item
1	203 mm (8 in.)	152 mm (6 in.) Cast iron
2	203 mm (8 in.)	152 mm (6 in.) Steel
3	178 mm (7 in.)	102 mm (4 in.) EMT *
4	178 mm (7 in.)	102 mm (4 in.) Cast iron
5	127 mm (5 in.)	51 mm (2 in.) Steel
6	127 mm (5 in.)	51 mm (2 in.) EMT *

* EMT = electrical metallic tubing (typically used for electrical conduits)

The opening perimeters were fire stopped using Hilti CP 606 FS (Red) joint filler on both sides (exposed and unexposed), installed from 25 to 38 mm (1 to 1½ in.) in the annular space (gap between the penetrating items and the hole on the CLT) and to a depth of 25 mm (1 in.) into the annular space. Mineral wool insulation was placed in between the joint filler and the ends of the pipes were closed with ceramic fiber blanket rolled up on the exposed side. The assembly was evaluated on December 17, 2013.

Unexposed surface thermocouples, as required by CAN/ULC S115, were mounted on the unexposed surface to determine eligibility for T-ratings. Details and pictures of the thermocouple locations can be found in the laboratory test report [12].

5 RESULTS

The results presented herein are a summary of those found in the laboratory test reports [6-11] and observations detailed in [2]. Further details such as the complete temperature readings from the thermocouples can be found in the complete reports, attached in Appendix I to VI.

For all five (5) samples, the same furnace was used with the same design time-temperature curve for the operator to follow. The CAN/ULC S101 standard time-temperature curve was used, which is the curve referenced in the CAN/ULC S115 standard. It is noted that although the operators attempted to follow the CAN/ULC S101 curve to the best of their abilities, the actual time-temperature curve exposing the samples were different for each sample due to the unpredictable nature of fire. Samples that have been subjected to a significant higher fire exposure are described below, namely samples 2 and 3.

5.1 Horizontal Fire Stop (Floor-to-Wall No.1)

The fire exposure during test sample 1 was very close to the standard CAN/ULC S101 time-temperature curve.

As mentioned in section 4.1 of this report, joint filler was initially applied to seal both the exposed and unexposed sides of the 13 mm ($\frac{1}{2}$ in.) gap, but the filler on the exposed side was removed prior to the test. Little bits of filler were still apparent, but not enough to significantly seal the gap to less than 13 mm on the exposed side. Negligible intumescent effects were visible in the filler. Therefore, it was adequate to assume that the joint fire stop was applied to the unexposed side only.

The test ended at 95 minutes with the unexposed side of the 5-ply wall still cold. It was found that the 3-ply floor got very hot near the end of the test, with a maximum temperature of approximately 125°C, which is still within the CAN/ULC-S115 standard limit temperature rise of 180°C above the initial temperature. The thermocouples on the joints were still relatively cool at approximate room temperature.

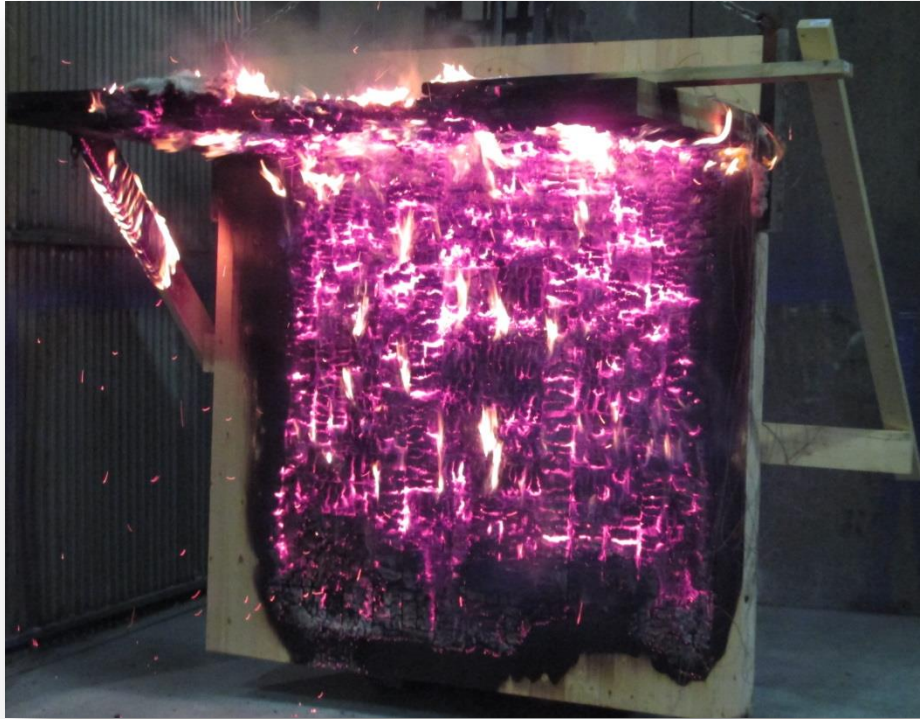

Figure 8. Test sample No.1 removed from furnace

The back end (away from the 5-ply wall) of the 3-ply floor was charred most significantly. This is likely due to high local turbulence. It was observed at the end of the test that most, if not all of the floor slab, was charred and approximately 2.5 layers of the wall charred off.

No flames were observed through the joint fire stop, floor, or wall. The joint fire stop remained intact for 95 minutes, which would yield into an FT-rating of 1½ hours.

5.2 Horizontal Fire Stop (Floor-to-Wall No.2)

Although test sample 2 is very similar in assembly as test sample 1, the furnace temperature during the sample 2 testing was generally much higher than the sample 1 test. The maximum furnace temperature reached approximately 1200°C (2200°F) towards the end of the test. As the actual furnace temperature was significantly higher than the CAN/ULC S 101 time-temperature curve (Figure 9), the results of this test are considered conservative.

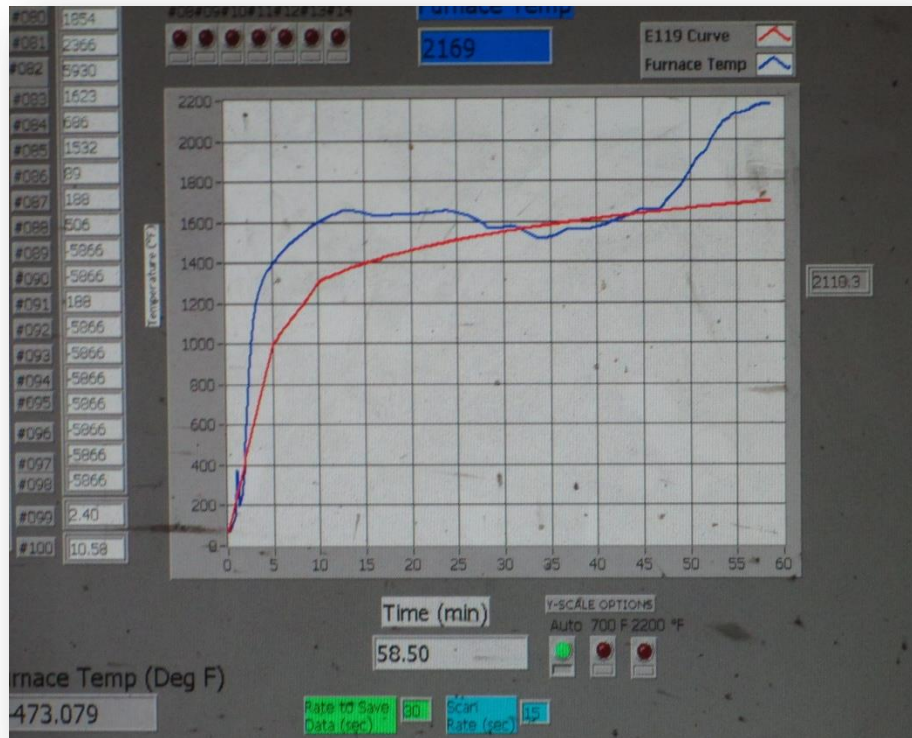

Figure 9. Time-temperature curve during test sample No.2

The test was stopped after 1 hour due to the overwhelming heat in the furnace. The sample was offset from the center; hence a large amount of smoke escaped through the side during the test. Nevertheless, the temperature rise on the unexposed side of the thermocouples stayed relatively low.

It was noticed that the exhaust of the furnace was significantly radiating heat to the unexposed side of the floor. Therefore, the thermocouple on the unexposed side of the floor located close to the furnace exhaust consistently displayed higher temperature than the other thermocouples.

No flames were observed through the joint fire stop, floor, or wall. The joint fire stop remained intact for 60 minutes, which would yield into an FT-rating of 1 hour.

5.3 Horizontal Fire Stop (Wall-to-Floor)

As with test sample 2, the furnace temperature during the sample 3 testing was generally much higher than the CAN/ULC S101 time-temperature curve (Figure 10), the results of this test are judged conservative.

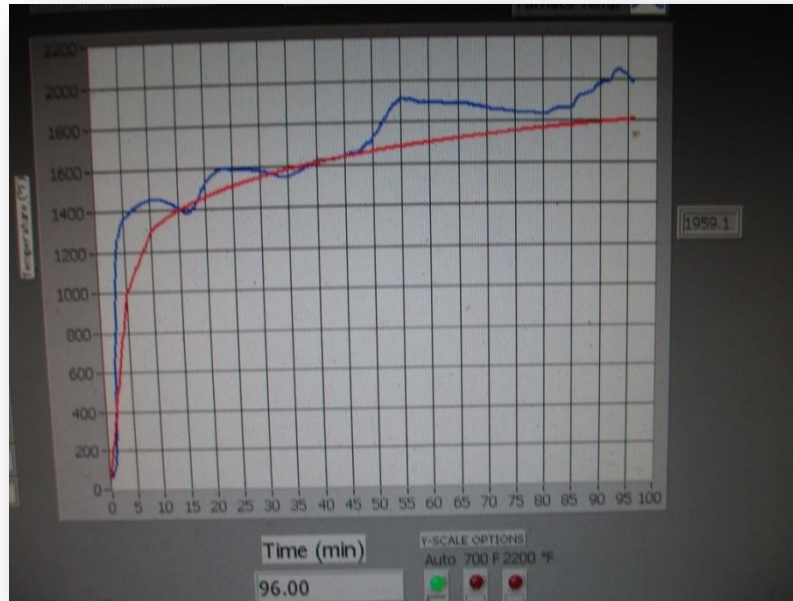

Figure 10. Time-temperature curve during test sample No.3

After 83 minutes in the test, the thermocouples on the unexposed side of the joint fire stop read roughly 21°C, while the thermocouples on the unexposed side of the 3-ply floor slab read between 60°C to 104°C. The higher temperature within the range (104°C) of the floor slab was physically closer to the furnace exhaust than the lower range (60°C) of the floor slab. This would suggest that the furnace exhaust may have affected the temperature readings of the thermocouples on the unexposed side of the floor.

At 89 minutes, sap was observed on the unexposed side of the 3-ply floor slab. At 95 minutes, smoke was observed leaking through the cracks of the 3-ply floor. The test was stopped at 96 min, at which point flaming through the floor slab was observed (Figure 11). However, no flames or smoke were observed through the joint fire stop or the 5-ply wall.



Figure 11. Visual observations from test sample No.3

No flames were observed through the joint fire stop or wall. The joint fire stop remained intact for 96 minutes, which would yield into an FT-rating of 1½ hour.

5.4 Horizontal Fire Stop (Floor-to-Floor)

The fire exposure during test sample 4 was very close to the standard CAN/ULC S101 time-temperature curve.

At approximately 108 minutes, smoke was observed in the middle of the 3-ply CLT slab; however, flames did not propagate through the floor. The test was stopped after 120 minutes at which point, the highest temperature reading from all thermocouples was 115°C which was recorded at the center of one of the floor slabs (Figure 12). As with test sample 3, it was observed that the thermocouples closer to the furnace exhaust displayed higher temperatures than those away from the furnace exhaust. Nevertheless, the readings from the thermocouples at the joints remained relatively low at approximately 27°C.

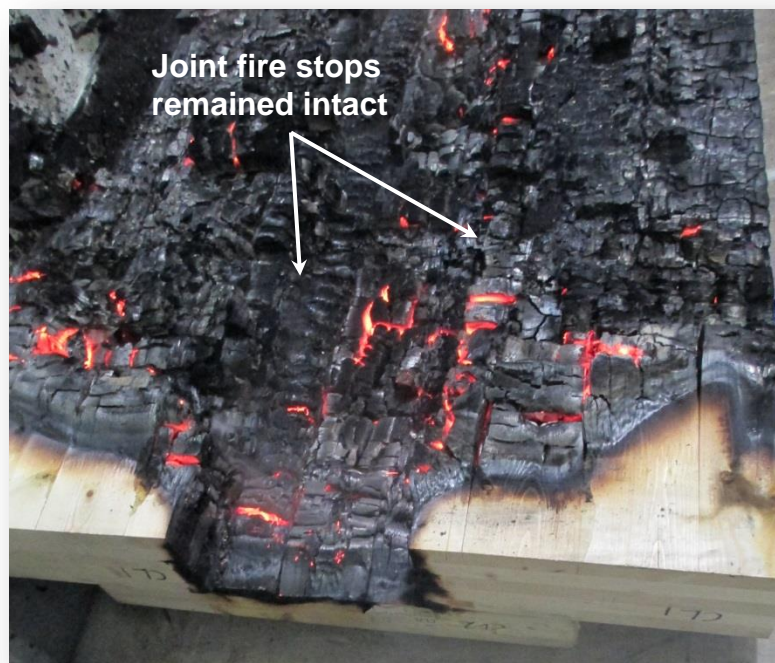

Figure 12. Test sample No.4 removed from furnace

No flames were observed through the joint fire stops or the floor slabs. The joint fire stops remained intact for 120 minutes, which would yield into an FT-rating of 2 hours.

5.5 Horizontal Fire Stop (Stair landings)

The fire exposure during test sample 5 was very close to the standard CAN/ULC S101 time-temperature curve.

No significant events were observed throughout the test with the exception of flames periodically escaping through the outer perimeter of the sample due to gaps formed between the furnace and the

sample. This occurred after approximately 82 minutes, at which time the first layer of CLT had already burnt off. Throughout the test, ceramic fiber insulation was added to the gaps formed between the sample and the furnace due to the charring of wood.

No smoke was observed coming through the wood or the joint fire stops throughout the test, which ended after 120 minutes. All thermocouple temperatures remained relatively cool with maximum temperature approximately 71°C.

It was observed that the middle portion of the three 5-ply CLT panels was charred more significantly than the other two. This is likely due to the angle at which the middle panel is assembled. Nevertheless, only two layers had charred off, with the third layer significantly charred.

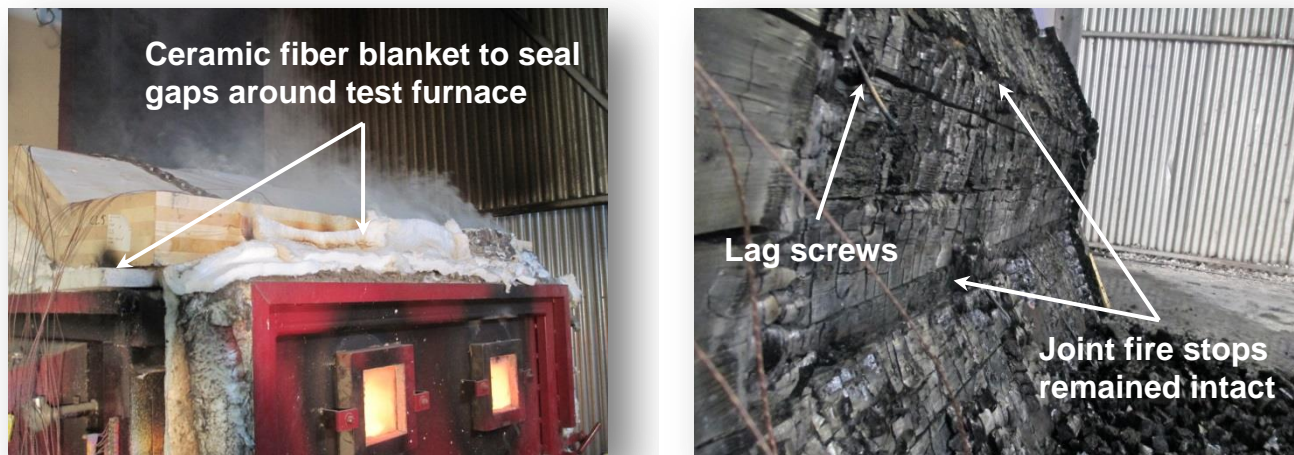

Figure 13. Visual observations from test sample No.5

No flames were observed through the joint fire stops or the floor slabs. The joint fire stops remained intact for 120 minutes, which would yield into an FT-rating of 2 hours.

5.6 Through-Penetration Fire Stops

The fire exposure during test sample 6 was very close to the standard CAN/ULC S101 time-temperature curve.

Shortly after 16 minutes in the test, the thermocouples assigned for the 102 mm (4 in.) EMT pipe read temperatures beyond the CAN/ULC-S115 standard limit temperature rise of 180°C above the initial temperature, followed by the 102 mm (4 in.) cast iron, 152 mm (6 in.) steel and cast iron and 51 mm (2 in.) steel pipes at 20, 22, 28 and 39 minutes respectively. The 51 mm (2 in.) EMT pipe reached the temperature limit at 50 minutes.

With respect to temperature measurements at the unexposed surface of the joint fire stops, the 152 mm (6 in.) steel and cast iron pipes were the first to reach the CAN/ULC-S115 standard limit temperature rise of 180°C above the initial temperature at 45 and 48 minutes. The 102 mm (4 in.) cast iron and EMT and the 51 mm (2 in.) steel pipe reached the temperature criterion after 49, 49 and 52 minutes respectively. The maximum temperature measured at the unexposed surface of the joint fire stop of the 51 mm (2 in.) EMT pipe was 44°C, at 90 minutes.

Figure 14 shows the unexposed surface of the 102 mm (4 in.) cast iron pipe during the test while Figure 15 shows the exposed surface of the entire assembly after being removed from the furnace.



Figure 14. Unexposed surface of the 4 in. cast iron pipe during the test



Figure 15. Test sample No.6 removed from furnace

No flames were observed through the joint fire stops around all 6 pipes. The joint fire stops remained intact for 91 minutes, which would yield into an F-rating of 1½ hours.

6 DISCUSSION AND RECOMMENDATIONS

Fire stop systems are designed to maintain the integrity of a fire compartment by maintaining the fire-resistance rating of floor and/or wall assemblies at penetrations and construction joints. As mentioned previously in this report, there are many fire stop systems that have been approved for use with concrete and/or light frame assemblies. As such, fire stop systems in mass timber may be based on similar systems currently used in concrete and light frame assemblies. In fact, the results from this test series show two features of significant importance relating to fire stopping mass timber construction:

- 1) Joint fire stops need to be installed at a location that will not be affected by potential charring of the wood. Degree of charring can be calculated by generally accepted methods.
- 2) Through-penetration fire stops, subject to review of conformity of material compatibility, need to be installed in an acceptable arrangement to limit their effect on ignition or charring of the wood.

With respect to item 1 identified above, the results from this test series show that proper fire protection can be afforded by the joint fire stop, when installed away from the exposed surface (Figure 16). When comparing the results from the 3 horizontal fire stops (assemblies described in subsections 4.1 to 4.3 of this report), it can be observed that the joint fire stops performed much better when they are not directly exposed to fire (sample 1 achieved a FT-rating of 1½ hours while sample 2 only reached 1 hour).

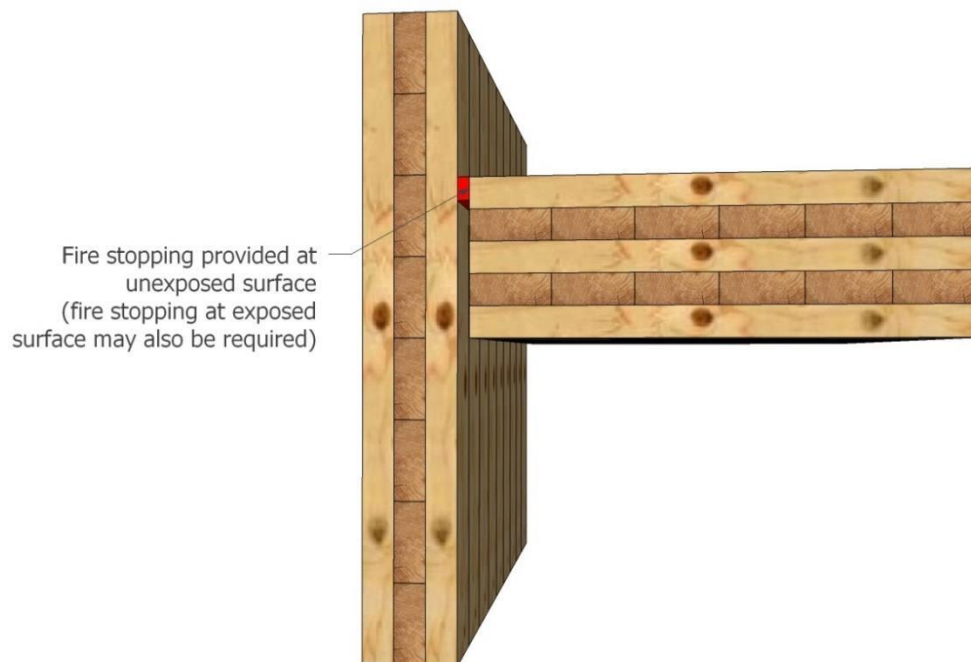

Figure 16. Joint fire stopping located at unexposed surface

While it is common practice in concrete construction to leave through-penetrating items “sitting” on the concrete opening, the results gathered from this test series suggest that it is fundamental in mass timber plate construction that through-penetrating items do not directly interact or touch the timber components to limit heat transfer conducted from the penetrating item to the surrounding timber, which could lead to premature ignition, charring and potential flame penetration (

Figure 17). It is also important that any gap(s) within the fire stop joint filler is filled with an appropriate thermal insulation such as rock or mineral wool to prevent convective heat transfer from the through-penetrating item and the surrounding timber component.

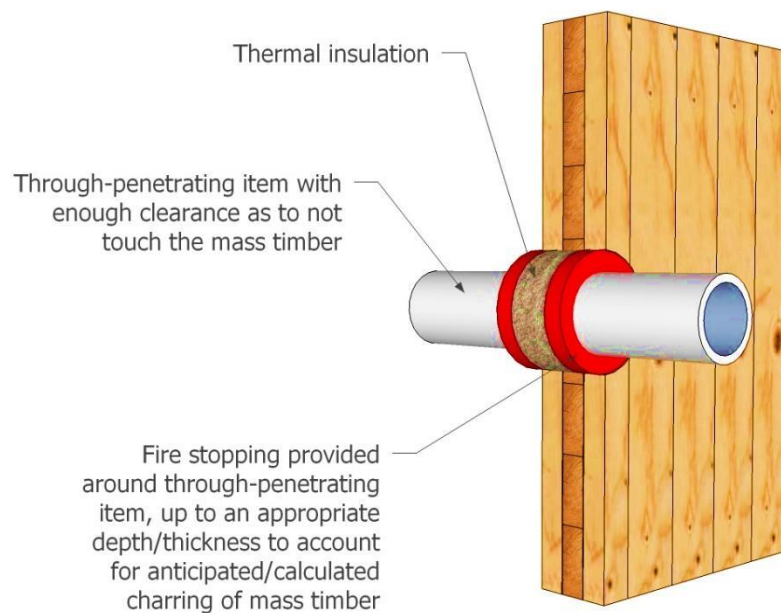

Figure 17. Fire stopping of through-penetrations

7 CONCLUSION

Mass timber plates, such as CLT, bear similarities to concrete and light frame assemblies and suggest that currently approved fire stops may be applicable to mass timber plate construction. However, a recent literature review – conducted by a CHM Fire Consultants on behalf of FPInnovations – identified that there are currently no listed fire stop systems available for service penetrations in mass timber plate construction in North America, thus increasing the difficulty for designers in gaining acceptance of a proposed design from an Authority Having Jurisdiction. To assess the fire-protection F- and T-ratings of selected commercially available joint fire stop systems and configurations, a total of five (5) CLT assemblies with linear openings (construction joints) and one (1) CLT assembly having six (6) through-penetrations have been evaluated in accordance with CAN/ULC S115 test method. The fire stops used in this test series are widely used in concrete and light frame construction.

The five (5) samples evaluated with linear openings (construction joints) replicate typical construction where floor-to-wall, wall-to-floor and floor-to-floor assemblies as well as stair landings. FT-ratings obtained from the test results vary from 1 to 2 hours. When installed and detailed properly, a floor-to-wall joint can achieved a FT-rating of 1 and 1½ hour. The longest rating has been observed on the assembly where the fire stop is located away from the exposed surface (e.g. unexposed surface to fire). Such 1½ hour rating is that required for closures used in fire separations required to provide a fire-resistance rating of 2 hours

The sample evaluated with through-penetrations showed that 1½ hour F-rating can be achieved. As with the previous five (5) samples, such rating is that required for service penetrations used in fire separations required to provide a fire-resistance rating of 2 hours.

The results from this test series show two (2) features of significant importance relating to fire stopping mass timber construction:

- 1) Joint fire stops need to be installed at a location that will not be affected by potential (i.e anticipated/calculated) charring of the wood;
- 2) Through-penetration fire stops need to be installed in an acceptable arrangement to limit their effect on ignition or charring of the wood.

While it is common practice in concrete construction to leave through-penetrating items “sitting” on the concrete opening, the results gathered from this test series suggest that it is fundamental in mass timber plate construction that through-penetrating items do not directly interact or touch the timber components to limit heat transfer conducted from the penetrating item to the surrounding timber, which could lead to premature ignition, charring and potential flame penetration. It is also important that any gap(s) within the fire stop joint filler is filled with an appropriate thermal insulation such as rock or mineral wool to prevent convective heat transfer from the through-penetrating item and the surrounding timber component.

Proper detailing of fire stops and through-penetrations are to be carefully thought and planned in the early phase of the designing stage. Proper field inspection is also an important feature to ensure that the designed fire stops are properly installed as planned. Since fire stopping is a performance attribute required in the NBCC, proper detailing, installation and field inspection is applicable to all types of construction.

8 REFERENCES

- [1] ULC, Standard Method of Fire-Tests of Firestop Systems (ULC S115), Toronto (Ont.): Underwriters Laboratories of Canada, 2011.
- [2] J. H. Kim et A. Harmsworth, «Observations of CLT Firestop Tests - Wall and Floor Assemblies Tested at Intertek,» GHl Consultants Ltd., Vancouver, BC, 2014.
- [3] C. Dagenais, «Literature Review: Fire Stop Requirements as Related to Massive Wood Wall and Floor Assemblies (Project No. 301006155),» FPIinnovations, 2013.
- [4] NRCC, National Building Code - Canada (volume 1), Ottawa, Ontario: National Research Council Canada, 2010.
- [5] NRCC, National Building Code - Canada (volume 2), Ottawa, Ontario: National Research Council Canada, 2010.
- [6] ANSI, Standard for Performance-Rated Cross-Laminated Timber (ANSI/APA PRG 320-2012), New York (NY): American National Standards Institute, 2012.
- [7] ITS, «Horizontal Joint Firestop System (Report No. 101341829COQ-003A),» Intertek Testing Services NA Ltd., Coquitlam, BC, 2013.
- [8] ITS, «Horizontal Joint Firestop System (Report No. 101341829COQ-003B),» Intertek Testing Services NA Ltd., Coquitlam, BC, 2013.
- [9] ITS, «Horizontal Joint Firestop System (Report No. 101341829COQ-003C),» Intertek Testing Services NA Ltd., Coquitlam, BC, 2013.
- [10] ITS, «Horizontal Joint Firestop System (Report No. 101341829COQ-003D),» Intertek Testing Services NA Ltd., Coquitlam, BC, 2013.
- [11] ITS, «Horizontal Joint Firestop System (Report No. 101341829COQ-003E),» Intertek Testing Services NA Ltd., Coquitlam, BC, 2013.
- [12] ITS, «Through-Penetration Firestop Systems (Report Number No. 101460521COQ-003),» Intertek Testing Services NA Ltd., Coquitlam, BC, 2013.

Appendix I

Intertek Report Number 101341829COQ-003A (rev. Feb. 2014)

TEST REPORT

The Intertek logo consists of the word "Intertek" in a white, sans-serif font, centered within a dark blue rounded rectangular background.

REPORT NUMBER: 101341829COQ-003A
ORIGINAL ISSUE DATE: November 21, 2013
REVISION DATE: February 24, 2014

EVALUATION CENTER
Intertek Testing Services NA Ltd.
1500 Brigantine Drive
Coquitlam, B.C. V3K 7C1

RENDERED TO

PCL Constructors Canada Inc.
13911 Wireless Way, Suite 310
Richmond, B.C. V6V 3A4

PRODUCT EVALUATED: Horizontal Joint Firestop System
EVALUATION PROPERTY: Fire Resistance

Report of testing a Horizontal Joint Firestop System for compliance with the applicable requirements of the following criteria: CAN/ULC S115-11, *Standard Method of Fire Tests of Firestop Systems.*

This report is for the exclusive use of Intertek's Client and is provided pursuant to the agreement between Intertek and its Client. Intertek's responsibility and liability are limited to the terms and conditions of the agreement. Intertek assumes no liability to any party, other than to the Client in accordance with the agreement, for any loss, expense or damage occasioned by the use of this report. Only the Client is authorized to permit copying or distribution of this report and then only in its entirety. Any use of the Intertek name or one of its marks for the sale or advertisement of the tested material, product or service must first be approved in writing by Intertek. The observations and test results in this report are relevant only to the sample tested. This report by itself does not imply that the material, product, or service is or has ever been under an Intertek certification program.

1 Table of Contents

	PAGE
1 Table of Contents.....	2
2 Introduction	3
3 Test Samples	3
3.1. SAMPLE SELECTION	3
3.2. SAMPLE AND ASSEMBLY DESCRIPTION	3
4 Testing and Evaluation Methods.....	4
4.1. WALL FLOOR TEST INSTALLATION	4
4.2. UNEXPOSED THERMOCOUPLE LOCATIONS.....	4
4.3. THE FIRE TEST.....	5
5 Testing and Evaluation Results.....	7
5.1. FIRE TEST OBSERVATIONS.....	7
5.2. EXAMINATION OF RESULTS	7
6 Conclusion	8
APPENDIX A – Photographs.....	2 Pages
APPENDIX B – Temperature and Pressure Data.....	4 Pages
REVISION SUMMARY	

2 Introduction

Intertek Testing Services NA Ltd. (Intertek) has conducted testing for PCL Constructors Canada Inc. on a 1-hour fire test to evaluate firestop system for a wall floor/ceiling assembly with a horizontal joint using Hilti CP606 (Red) firestop caulking. The assembly was tested to CAN/ULC S115-11, *Standard Method of Fire Tests of Firestop Systems*.

This evaluation began October 22, 2013 and was on the same day.

3 Test Samples

3.1. SAMPLE SELECTION

Intertek did not select the specimen and did not verify the composition, manufacturing techniques or quality assurance procedures. The samples were received at the Evaluation Centre on October 18, 2013.

3.2. SAMPLE AND ASSEMBLY DESCRIPTION

The test assembly consisted of a 5 ply Cross Laminated Timber (CLT) wall, measuring 7 ft. wide by 7 ft. 5-7/8 in. high, and a 3 ply Cross Laminated Timber (CLT) floor/ceiling, measuring 7 ft. wide by 3 ft. 9-1/2 in. deep. A 1/2 in. gap was created between the floor and wall assembly using wood shims that were off set from the edge. The samples were fastened together using 10 in. lag screws.

A 1/2 in. thickness of "Hilti CP606 (Red)" firestop caulking was installed on the unexposed side, within the annulus, to a depth of 1 in.

4 Testing and Evaluation Methods

4.1. UNEXPOSED THERMOCOUPLE LOCATIONS

Unexposed surface thermocouples, as required by the Standard, were mounted on the unexposed surface to determine eligibility for T ratings. Thermocouple locations are indicated in the following table:

Thermocouple #	Thermocouple Location
1	12 in. from left side on wall behind annular space
2	42 in. from left hand side of wall behind annular space
3	12 in. from right side on wall behind annular space
4	12 in. from left side on floor/ceiling 1 in. from firestop interface
5	42 in. from left side on floor/ceiling 1 in. from firestop interface
6	12 in. from right side on floor/ceiling 1 in. from firestop interface
7	12 in. from left side on floor/ceiling on firestop caulking
8	42 in. from left side on floor/ceiling on firestop caulking
9	12 in. from right side on floor/ceiling assembly on firestop caulking
10	12 in. from left side on wall assembly 1 in. from firestop interface
11	42 in. from left side on wall assembly 1 in. from firestop interface
12	12 in. from right side on wall assembly 1 in. from firestop interface
13	Centre of floor ceiling assembly

4.2. THE FIRE TEST

The test assembly was mounted on our pilot scale fire test furnace. The furnace opening for horizontal fire separations has dimensions of 70 in. in width by 44 in. in length. The furnace opening for vertical fire separations has dimensions of 70 in. in width by 56 in. in height.

Furnace temperatures are measured by six uniformly distributed thermocouples. These readings were recorded by a Yokogawa data acquisition system (ID no. WH D3593/WH D3595) recorded every 30 seconds and displayed every 15 seconds. See Appendix C – Temperature Data. The wall assembly was subjected to the standard time/temperature curve of CAN/ULC S101-07 and the unexposed surface was observed.

Furnace pressures are measured by one probe, located 12 in. below the exposed surface of the horizontal fire separation. The exhaust opening is located along the back of the furnace. Four natural gas burners are located in the furnace floor, as are four secondary air inlets. A positive pressure of 0.010 in. water column (2.5 Pa.) was maintained in the furnace. The pressure was continuously monitored throughout the test duration.

The burners were ignited and controlled to maintain furnace temperature rise to conform as closely as possible to the standard time/temperature curve. Observations, furnace temperatures, the pressure differential, and unexposed temperatures were recorded throughout the test duration.

4.3. THE HOSE STREAM TEST

The hose stream portion of this test is optional and was declined by the client.

5 Testing and Evaluation Results

5.1. FIRE TEST OBSERVATIONS

TIME (min.)	EXPOSED SIDE	UNEXPOSED SIDE
0:30	Surface ignition	
8:35	Intensity of fire decreasing	
11:30	Surface has reignited	
17:00		Small area of caulk pulling away from floor ceiling assembly
50:00	Char falling from ceiling	
62:00	Char from wall has fallen away	Firestop material expanding
72:00	Char continues to fall away from wall	
84:00	Char continues to fall away	
90:00*	Test discontinued	

* At the request of the client, the test was extended to 90 minutes to collect temperature data.

5.2. EXAMINATION OF RESULTS

The following test sample achieved a 1-1/2 hour FT rating:

5 ply CLT wall system and 3 ply CLT floor/ceiling assembly with ½ in. thickness of “Hilti CP606 (Red)” firestop caulking installed on the unexposed side, within the annulus, to a depth of 1 in.

6 Conclusion

The PCL Constructors Canada Inc. wall floor/ceiling horizontal joint assembly, as described in this report, met the following 'F' and 'T' performance ratings in accordance with CAN/ULC S115-11, *Standard Method of Fire Tests of Firestop Systems*.

Assembly	Description	'F' Rating	'T' Rating	Hose Stream
1	5 ply CLT wall and 3 ply CLT floor/ceiling assembly with a ½ in. thickness of "Hilti CP606 (Red)" firestop caulking installed on the unexposed side, within the annulus, to a depth of 1 in.	1-1/2 Hr.	1-1/2 Hr.	N/A

The conclusions of this test report may not be used as part of the requirements for Intertek product certification. Authority to Mark must be issued for a product to become certified.

INTERTEK TESTING SERVICES NA LTD.

Tested and
Reported by:



Dave Park
Technician – Building Products

Reviewed by:



Greg Philp
Reviewer – Fire Testing

APPENDIX A

Photographs

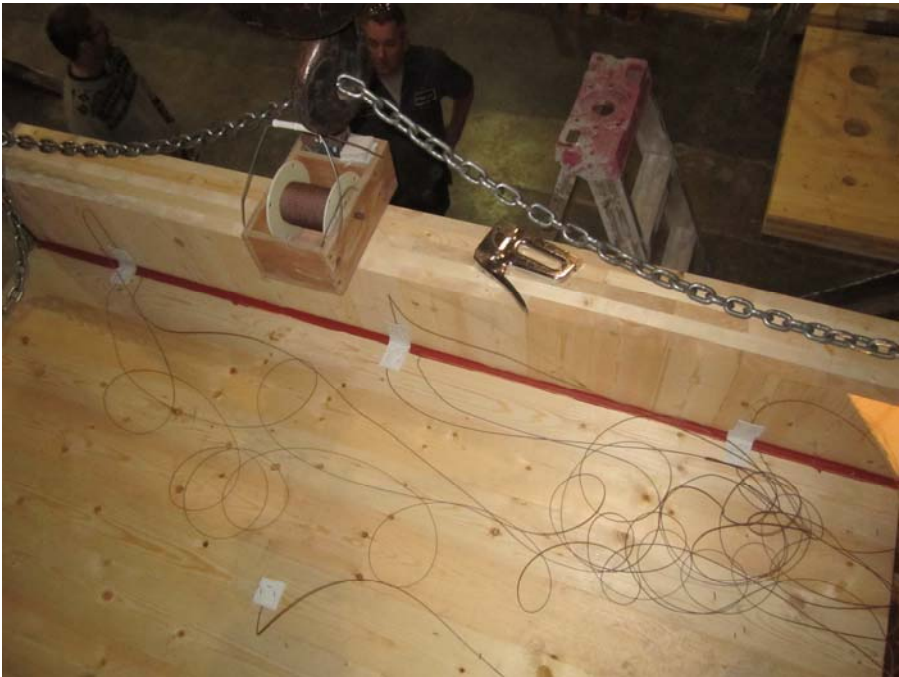

Unexposed Top Side Prior to the Fire Test



Unexposed Side Prior to the Fire Test



Exposed Side After Fire Test

APPENDIX B

Temperature Data

TIME TEMPERATURE CURVE AVERAGE TEMPERATURE OF FURNACE DURING THE FIRE TEST

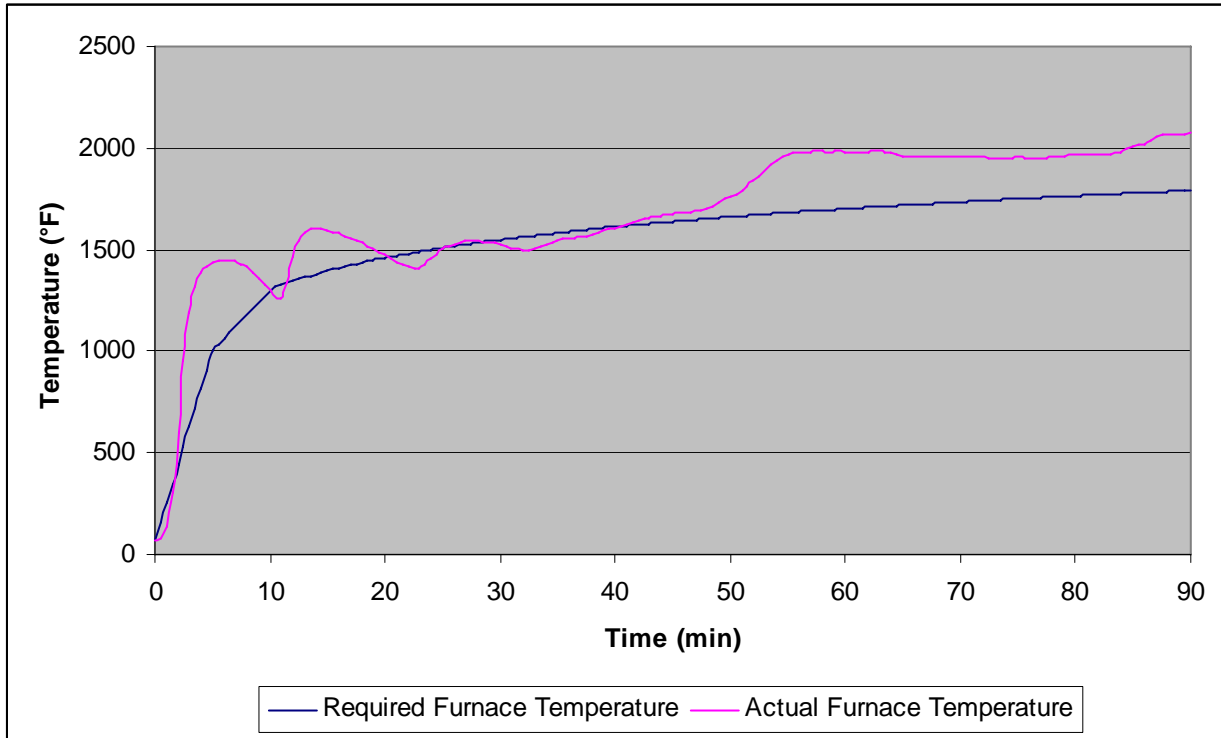

TIME PRESSURE CURVE
PRESSURE INSIDE THE FURNACE 12 IN. BELOW THE CEILING DURING THE FIRE TEST

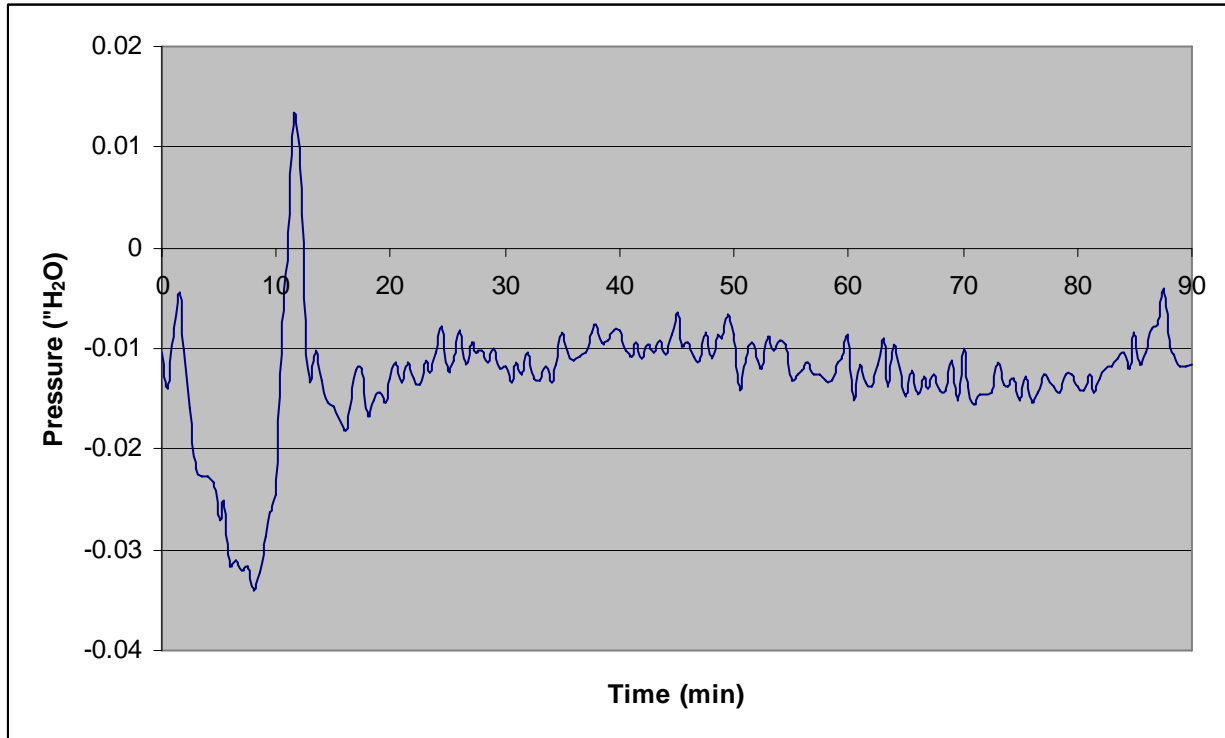

UNEXPOSED SURFACE TEMPERATURES (°F)

Time (min)	TC 1	TC 2	TC 3	TC 4	TC 5	TC 6	TC 7	TC 8	TC 9	TC 10	TC 11	TC 12	TC 13
0	67	68	67	67	68	67	67	68	67	67	68	67	69
1	67	67	67	69	71	69	68	69	68	69	70	69	73
2	67	68	67	79	83	81	74	70	70	77	76	75	85
3	67	68	67	87	94	91	85	75	76	92	93	88	103
4	67	68	67	88	97	94	88	76	78	95	97	92	105
5	67	68	67	87	97	95	90	78	81	95	99	94	105
6	67	68	67	88	98	94	93	79	83	95	100	94	105
7	67	68	67	88	97	94	95	81	85	95	100	95	104
8	67	68	67	86	95	93	96	81	86	94	99	95	102
9	67	68	67	84	93	91	97	82	86	92	97	93	100
10	67	68	67	83	91	88	97	82	87	90	95	92	97
11	67	67	67	81	88	86	98	83	87	88	93	90	94
12	66	67	67	83	89	87	101	84	89	90	94	91	95
13	67	68	67	90	100	96	110	87	94	99	104	98	108
14	67	69	67	92	104	100	113	90	97	102	108	102	113
15	67	69	67	93	105	102	117	91	100	104	110	104	114
16	67	69	67	93	105	101	120	93	102	105	110	104	114
17	67	70	67	92	104	101	122	94	105	105	110	104	113
18	67	69	67	91	103	100	125	95	107	104	109	104	111
19	66	69	66	91	102	98	127	96	110	104	108	103	110
20	66	69	66	90	101	98	130	97	112	103	107	103	108
21	66	69	66	89	100	97	131	98	114	103	106	102	106
22	66	69	66	88	98	96	133	99	117	102	105	102	105
23	66	69	66	88	98	96	135	100	119	103	104	101	105
24	66	69	66	90	99	96	137	102	122	104	105	102	106
25	66	69	66	90	100	98	140	104	124	106	106	104	108
26	66	69	66	92	101	100	142	106	127	108	108	105	109
27	66	69	66	92	103	101	144	108	129	110	109	106	110
28	66	69	66	93	103	101	146	110	132	111	110	108	111
29	66	69	66	93	103	102	147	112	134	111	110	108	111
30	66	69	66	94	104	102	149	114	136	112	111	109	111
31	66	69	66	94	104	102	150	116	138	112	111	109	110
32	66	69	66	93	104	102	151	119	139	112	111	110	110
33	66	69	66	94	104	102	153	121	141	113	111	110	111
34	66	69	66	95	105	103	154	124	143	115	113	112	112
35	66	69	66	96	106	104	156	127	145	116	114	113	112
36	66	69	66	97	107	105	158	129	147	117	115	114	114
37	66	69	66	97	108	106	159	132	149	118	116	115	114
38	66	70	66	98	109	107	161	135	151	120	117	117	115
39	66	70	66	100	111	108	163	137	153	121	119	118	117
40	66	70	66	100	112	109	164	140	154	123	120	120	118
41	66	70	66	102	114	111	167	143	156	125	122	122	120
42	66	70	66	104	116	114	169	146	158	127	125	124	123
43	66	70	66	106	118	116	171	148	159	129	127	126	125

UNEXPOSED SURFACE TEMPERATURES (°F)
 Continued

Time (min)	TC 1	TC 2	TC 3	TC 4	TC 5	TC 6	TC 7	TC 8	TC 9	TC 10	TC 11	TC 12	TC 13
44	66	70	66	107	121	118	173	151	161	131	130	128	127
45	66	70	66	109	123	120	175	154	162	133	132	130	130
46	66	70	66	110	124	121	177	156	164	135	134	132	131
47	66	71	66	112	127	123	179	159	165	137	137	135	133
48	66	71	66	113	128	125	181	161	167	139	139	137	136
49	66	71	66	115	131	127	182	163	169	141	142	139	138
50	67	71	66	119	135	131	186	166	171	146	147	143	143
51	66	72	66	121	140	136	189	170	174	151	152	148	150
52	67	73	66	130	151	146	195	174	180	161	163	157	163
53	67	74	66	137	161	156	199	178	184	170	173	166	174
54	68	75	67	147	173	167	206	184	190	183	188	177	190
55	68	77	67	155	186	178	211	190	195	193	200	187	203
56	68	77	67	160	192	184	213	194	199	199	208	193	209
57	68	77	68	162	195	187	215	197	201	203	212	197	213
58	68	78	68	165	198	188	216	200	204	206	215	198	213
59	69	78	68	168	202	190	219	204	207	210	220	202	218
60	69	78	68	170	204	192	220	207	209	211	222	204	219
61	69	78	68	170	205	192	220	209	211	211	222	205	220
62	69	78	68	172	206	194	221	211	212	213	224	207	220
63	69	79	68	173	208	195	222	213	214	214	226	208	222
64	69	79	68	173	208	195	222	215	215	214	226	209	221
65	69	79	68	171	206	194	221	216	215	212	225	209	220
66	69	79	68	172	206	193	221	217	216	211	224	209	218
67	69	78	68	173	206	193	221	217	216	212	224	209	218
68	69	78	68	173	206	193	221	218	216	212	224	209	218
69	69	79	68	174	206	194	221	219	217	213	224	210	218
70	69	78	68	176	207	195	221	220	218	213	225	210	219
71	69	78	68	175	209	195	221	220	218	213	226	211	219
72	69	78	68	176	209	196	221	220	218	213	226	211	220
73	69	78	68	177	209	195	222	221	218	215	226	211	220
74	69	78	68	177	208	194	221	220	218	214	225	210	218
75	69	78	68	178	209	194	221	221	218	215	225	211	219
76	69	78	68	178	210	195	221	221	218	215	226	211	219
77	69	78	68	178	210	195	221	220	218	216	226	211	219
78	69	78	68	180	211	195	222	221	219	218	227	212	221
79	69	78	68	181	212	196	222	221	219	217	228	213	222
80	69	78	68	183	213	197	222	222	219	220	229	214	223
81	69	78	68	183	213	198	223	222	219	220	230	215	225
82	69	78	68	185	216	199	224	222	220	222	232	215	227
83	69	78	68	187	219	201	226	223	220	225	235	217	229
84	69	79	68	190	223	204	228	224	221	229	238	220	234
85	70	79	68	195	229	210	231	226	223	234	243	225	241
86	70	80	68	199	236	215	234	227	224	237	246	228	246
87	70	80	69	206	242	221	240	228	226	242	251	234	251
88	70	82	69	207	240	222	244	229	226	246	255	237	254
89	70	81	69	208	242	224	249	231	226	249	259	240	257
90	70	80	69	211	245	227	254	232	227	252	263	244	262

REVISION SUMMARY

DATE	PAGE	SUMMARY	INITIAL
November 21, 2013	--	Original Issue Date	--
February 24, 2014	6, 7	Updated FT Rating to 1-1/2 hour	

Appendix II

Intertek Report Number 101341829COQ-003B (Nov. 2013)

TEST REPORT

Intertek

REPORT NUMBER: 101341829COQ-003B
ORIGINAL ISSUE DATE: November 21, 2013

EVALUATION CENTER
Intertek Testing Services NA Ltd.
1500 Brigantine Drive
Coquitlam, B.C. V3K 7C1

RENDERED TO

**PCL Constructors Canada Inc,
13911 Wireless Way, Suite 310
Richmond, B.C. V6V 3A4**

PRODUCT EVALUATED: Horizontal Joint Firestop System
EVALUATION PROPERTY: Fire Resistance

Report of testing a Horizontal Joint Firestop System for compliance with the applicable requirements of the following criteria: CAN/ULC S115-11, *Standard Method of Fire Tests of Firestop Systems.*

This report is for the exclusive use of Intertek's Client and is provided pursuant to the agreement between Intertek and its Client. Intertek's responsibility and liability are limited to the terms and conditions of the agreement. Intertek assumes no liability to any party, other than to the Client in accordance with the agreement, for any loss, expense or damage occasioned by the use of this report. Only the Client is authorized to permit copying or distribution of this report and then only in its entirety. Any use of the Intertek name or one of its marks for the sale or advertisement of the tested material, product or service must first be approved in writing by Intertek. The observations and test results in this report are relevant only to the sample tested. This report by itself does not imply that the material, product, or service is or has ever been under an Intertek certification program.

1 Table of Contents

	PAGE
1 Table of Contents	2
2 Introduction	3
3 Test Samples	3
3.1. SAMPLE SELECTION	3
3.2. SAMPLE AND ASSEMBLY DESCRIPTION	3
4 Testing and Evaluation Methods.....	4
4.1. WALL FLOOR TEST INSTALLATION	4
4.2. UNEXPOSED THERMOCOUPLE LOCATIONS	4
4.3. THE FIRE TEST	5
5 Testing and Evaluation Results	7
5.1. FIRE TEST OBSERVATIONS	7
5.2. EXAMINATION OF RESULTS.....	7
6 Conclusion	8
APPENDIX A – Photographs	2 Pages
APPENDIX B – Temperature and Pressure Data.....	12 Pages
REVISION SUMMARY	

2 Introduction

Intertek Testing Services NA Ltd. (Intertek) has conducted testing for PCL Constructors Canada Inc. on a 1-hour fire test to evaluate firestop system for a wall floor/ceiling assembly with a horizontal joint using Hilti CP606 (Red) firestop Caulking on the exposed side. The assembly was tested to CAN/ULC S115-11, *Standard Method of Fire Tests of Firestop Systems*.

This evaluation began October 22, 2013 and was completed on the same day.

3 Test Samples

3.1. SAMPLE SELECTION

Intertek did not select the specimen and did not verify the composition, manufacturing techniques or quality assurance procedures. The samples were received at the Evaluation Centre on October 18, 2013.

3.2. SAMPLE AND ASSEMBLY DESCRIPTION

The test assembly consisted of a 5 ply Cross Laminated Timber (CLT) wall, measuring 7 ft. wide by 7 ft. 5-7/8 in. high, and a 3 ply Cross Laminated Timber (CLT) floor/ceiling measuring 7 ft. wide by 3 ft, 9-1/2 in. deep. A 1/2 in. gap was created between the floor and wall assembly using wood shims that were off set from the edge. The samples were fastened together using 10 in. lag screws.

A 1/2 in. thickness of "Hilti CP606 (Red)" firestop caulking was installed on the exposed side, within the annulus, to a depth of 1 in.

4 Testing and Evaluation Methods

4.1. UNEXPOSED THERMOCOUPLE LOCATIONS

Unexposed surface thermocouples, as required by the Standard, were mounted on the unexposed surface to determine eligibility for T ratings. Thermocouple locations are indicated in the following table:

Thermocouple #	Thermocouple Location
1	12 in. from left side on wall behind annular space
2	42 in. from left hand side of wall behind annular space
3	12 in. from right side on wall behind annular space
4	12 in. from left side on floor/ceiling 1 in. from annular space
5	42 in. from left side on floor/ceiling 1 in. from annular space
6	12 in. from right side on floor/ceiling 1 in. from annular space
7	12 in. from left side on floor/ceiling at edge of annular space
8	42 in. from left side on floor/ceiling at edge of annular space
9	12 in. from right side on floor/ceiling at edge of annular space
10	12 in. from left side on wall assembly 1 in. from annular space
11	42 in. from left side on wall assembly 1 in. from annular space
12	12 in. from right side on wall assembly 1 in. from annular space
13	Centre of floor ceiling assembly

4.2. THE FIRE TEST

The test assembly was mounted on our pilot scale fire test furnace. The furnace opening for horizontal fire separations has dimensions of 70 in. in width by 44 in. in length. The furnace opening for vertical fire separations has dimensions of 70 in. in width by 56 in. in height.

Furnace temperatures are measured by six uniformly distributed thermocouples. These readings were recorded by a Yokogawa data acquisition system (ID no. WH D3593/WH D3595) recorded every 30 seconds and displayed every 15 seconds. See Appendix C – Temperature Data. The wall assembly was subjected to the standard time/temperature curve of CAN/ULC S101-07 and the unexposed surface was observed.

Furnace pressures are measured by one probe, located 12 in. below the exposed surface of the horizontal fire separation. The exhaust opening is located along the back of the furnace. Four natural gas burners are located in the furnace floor, as are four secondary air inlets. A positive pressure of 0.010 in. water column (2.5 Pa.) was maintained in the furnace. The pressure was continuously monitored throughout the test duration.

The burners were ignited and controlled to maintain furnace temperature rise to conform as closely as possible to the standard time/temperature curve. Observations, furnace temperatures, the pressure differential, and unexposed temperatures were recorded throughout the test duration.

4.3. THE HOSE STREAM TEST

The hose stream portion of this test is optional and was declined by the client.

5 Testing and Evaluation Results

5.1. FIRE TEST OBSERVATIONS

TIME (min.)	EXPOSED SIDE	UNEXPOSED SIDE
0:42	Surface ignition	
25:00		Venting from firestop joint
43:00	Char falling from ceiling	
47:30		Visible smoke from firestop joint
51:45	Char falling from ceiling	
59:50		Smoke escaping from firestop joint
60:00	Test discontinued	

5.2. EXAMINATION OF RESULTS

The following test sample achieved a 1 hour FT rating:

5 ply CLT wall system and 3 ply CLT floor/ceiling assembly with a ½ in. thickness of “Hilti CP606 (Red)” firestop caulking installed on the exposed side, within the annulus, to a depth of 1 in.

6 Conclusion

The PCL Constructors Canada Inc. wall floor/ceiling horizontal joint assembly, as described in this report, met the following 'F' and 'T' performance ratings in accordance with CAN/ULC S115-11, *Standard Method of Fire Tests of Firestop Systems*.

Assembly	Description	'F' Rating	'T' Rating	Hose Stream
2	5 ply CLT wall and 3 ply CLT floor/ceiling assembly with a ½ in. thickness of "Hilti CP606 (Red)" firestop caulking installed on the exposed side, within the annulus, to a depth of 1 in.	1 Hr.	1 Hr.	N/A

The conclusions of this test report may not be used as part of the requirements for Intertek product certification. Authority to Mark must be issued for a product to become certified.

INTERTEK TESTING SERVICES NA LTD.

Tested and
Reported by:



Dave Park
Technician – Building Products

Reviewed by:



Greg Philp
Reviewer – Fire Testing

APPENDIX A

Photographs



Unexposed Top Side Prior to the Fire Test



Exposed Side Prior to the Fire Test



Exposed Side After Fire Test

APPENDIX B

Temperature Data

TIME TEMPERATURE CURVE
AVERAGE TEMPERATURE (°F) OF FURNACE DURING THE FIRE TEST

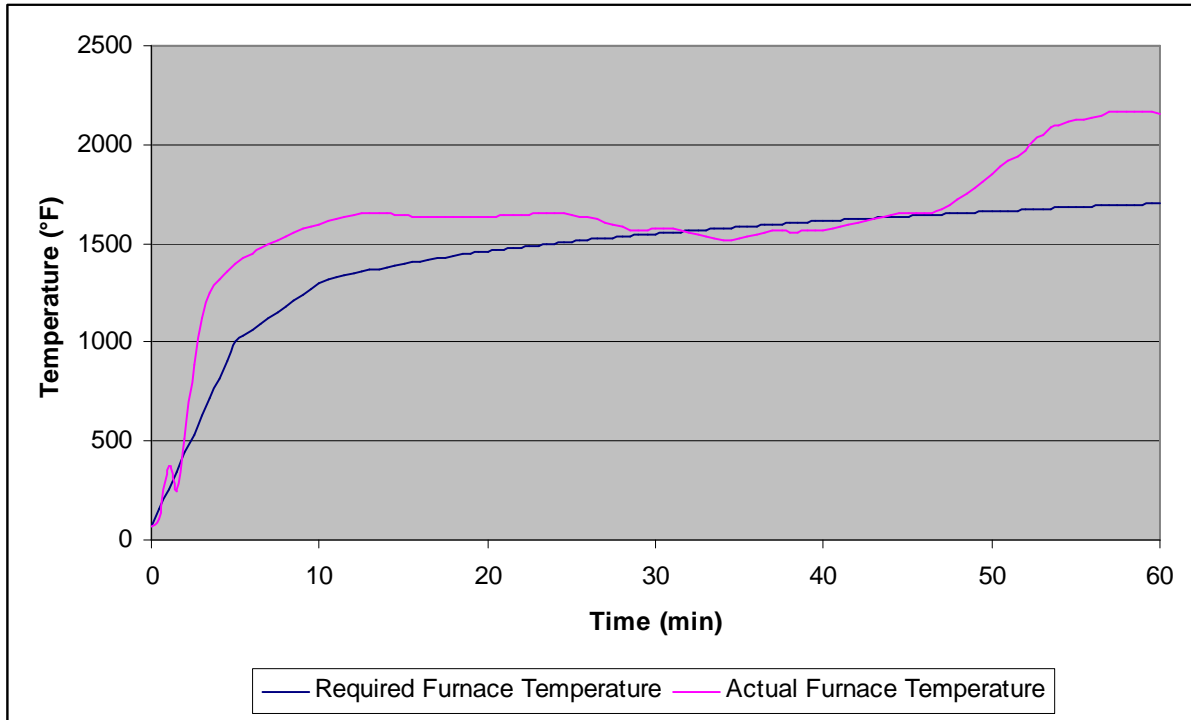

TIME PRESSURE CURVE
PRESSURE INSIDE THE FURNACE 12 IN. BELOW THE CEILING DURING THE FIRE TEST

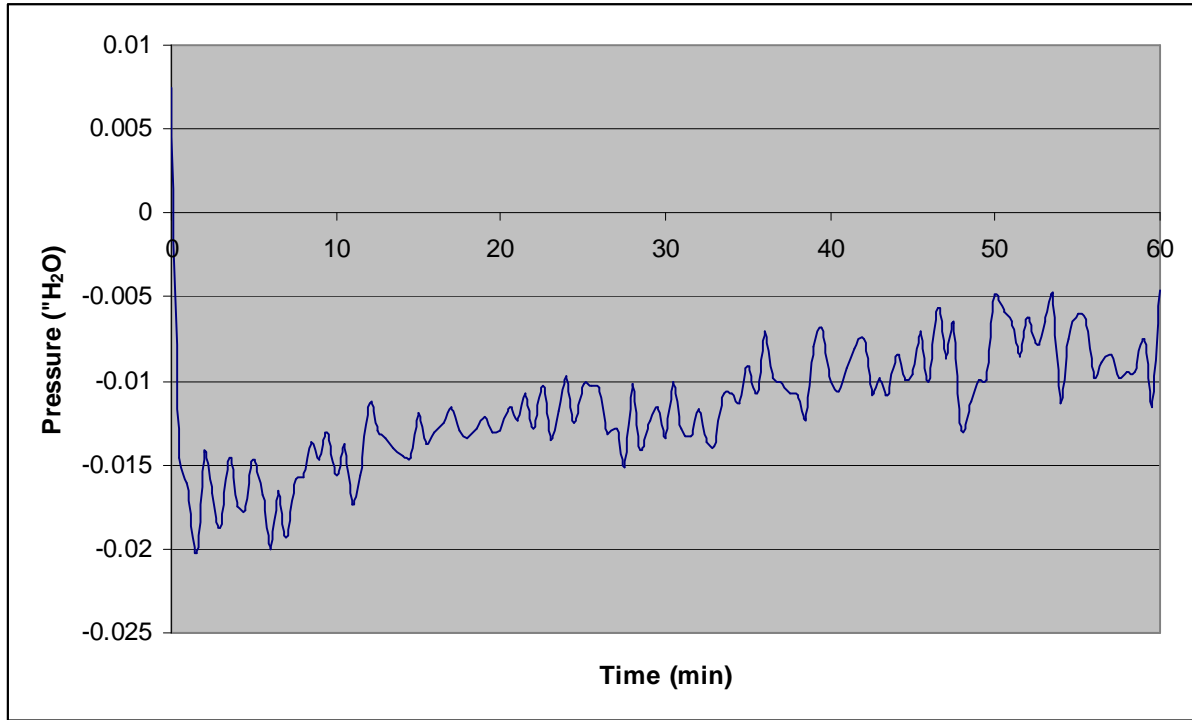

UNEXPOSED SURFACE TEMPERATURES (°F)

Time (min)	TC1	TC2	TC3	TC4	TC5	TC6	TC7	TC8	TC9	TC10	TC11	TC12	TC13
0	64	64	64	63	63	63	62	62	62	62	63	63	63
1	64	64	64	64	64	64	64	63	63	64	65	64	65
2	64	65	64	71	70	70	76	73	71	76	77	72	73
3	65	65	65	78	78	79	87	86	82	88	91	82	87
4	65	65	65	80	80	81	89	88	83	89	92	84	89
5	65	65	65	82	83	82	91	90	86	91	94	86	92
6	65	65	65	84	85	85	94	94	89	94	98	89	96
7	66	65	65	85	88	86	96	96	91	97	101	92	100
8	66	65	65	88	90	89	100	100	94	101	105	96	103
9	66	65	65	89	93	91	102	103	97	103	107	98	107
10	66	65	65	91	96	93	104	106	100	106	110	101	110
11	66	65	65	93	98	95	107	108	101	108	112	103	113
12	66	66	65	93	97	96	106	106	102	107	110	104	110
13	66	66	65	96	100	97	109	110	104	110	114	106	114
14	66	66	65	97	100	97	110	111	104	111	115	106	116
15	66	66	65	98	101	96	109	111	104	111	114	106	116
16	66	66	65	98	101	96	109	110	103	111	114	106	116
17	66	66	66	98	102	96	110	111	103	111	114	106	116
18	66	66	66	98	102	96	110	111	103	111	114	106	116
19	66	66	66	99	104	96	111	113	103	112	115	106	116
20	66	66	66	100	104	96	111	114	103	112	115	107	116
21	66	66	65	100	105	97	111	115	103	112	115	107	116
22	66	67	65	101	105	97	113	116	103	113	116	108	117
23	66	66	66	103	106	98	114	116	104	113	116	108	118
24	66	67	66	106	107	98	117	118	104	114	117	108	118
25	66	67	66	107	106	98	121	118	104	114	117	109	118
26	66	67	66	108	109	98	123	118	104	114	117	108	118
27	66	67	66	107	107	98	124	117	103	113	116	108	117
28	66	67	66	106	106	97	125	117	103	113	116	108	116
29	66	67	66	105	106	97	125	116	102	112	115	107	116
30	66	67	66	109	106	97	127	115	102	112	116	107	116
31	66	67	66	109	107	97	131	115	102	112	116	107	115
32	66	67	66	112	108	97	133	116	101	112	116	107	115
33	66	67	66	109	106	97	135	115	101	112	115	107	114
34	66	67	66	107	106	96	134	114	100	111	114	105	114
35	66	67	66	106	106	96	133	114	100	111	114	105	113
36	66	67	66	107	105	96	137	113	100	112	114	105	114
37	66	67	66	114	106	96	136	114	101	112	116	106	115
38	67	67	66	117	106	97	139	114	101	114	116	106	115
39	66	67	66	112	107	97	141	114	101	114	116	106	115
40	66	67	66	118	107	97	143	113	102	115	117	107	116

UNEXPOSED SURFACE TEMPERATURES (°F)
 Continued

Time (min)	TC1	TC2	TC3	TC4	TC5	TC6	TC7	TC8	TC9	TC10	TC11	TC12	TC13
41	67	67	66	116	108	98	144	114	102	116	118	107	117
42	67	67	66	117	109	99	147	115	103	118	119	108	118
43	67	67	66	118	109	100	147	116	104	119	121	109	119
44	67	67	66	120	111	101	150	118	106	121	123	111	121
45	67	67	66	118	112	102	154	119	107	122	125	112	122
46	67	68	66	125	114	103	154	121	108	123	126	113	124
47	67	68	66	122	115	104	158	123	109	126	128	114	125
48	67	68	66	127	116	106	159	123	112	128	129	117	127
49	67	68	67	129	119	109	164	130	116	133	136	121	133
50	67	68	67	133	125	115	171	138	123	141	144	128	141
51	68	68	67	134	131	121	179	147	132	150	155	136	151
52	68	69	67	142	139	130	189	158	144	159	167	147	162
53	68	69	67	151	150	143	204	175	160	178	185	162	179
54	69	70	68	159	159	152	215	186	171	190	197	172	192
55	69	70	69	169	166	157	227	197	179	205	206	181	203
56	70	70	69	174	189	159	231	213	181	212	211	184	208
57	70	70	69	177	197	162	234	236	185	218	218	188	214
58	70	70	69	181	200	163	237	260	186	223	223	191	217
59	71	70	69	183	204	165	238	274	189	224	226	194	220
60	71	71	70	185	216	166	236	295	189	224	226	195	220

REVISION SUMMARY

DATE	PAGE	SUMMARY	INITIAL
November 21, 2013	--	Original Issue Date	

Appendix III

Intertek Report Number 101341829COQ-003C (rev. Feb. 2014)

TEST REPORT

Intertek

REPORT NUMBER: 101341829COQ-003C
ORIGINAL ISSUE DATE: November 21, 2013
REVISION DATE: February 24, 2014

EVALUATION CENTER
Intertek Testing Services NA Ltd.
1500 Brigantine Drive
Coquitlam, B.C. V3K 7C1

RENDERED TO

PCL Constructors Canada Inc
13911 Wireless Way Suite 310
Richmond, BC V6V 3A4

PRODUCT EVALUATED: Horizontal Joint Firestop System
EVALUATION PROPERTY: Fire Resistance

Report of Testing Horizontal Joint Firestop System for compliance with the applicable requirements of the following criteria: CAN/ULC S115-11, *Standard Method of Fire Tests of Firestop Systems.*

This report is for the exclusive use of Intertek's Client and is provided pursuant to the agreement between Intertek and its Client. Intertek's responsibility and liability are limited to the terms and conditions of the agreement. Intertek assumes no liability to any party, other than to the Client in accordance with the agreement, for any loss, expense or damage occasioned by the use of this report. Only the Client is authorized to permit copying or distribution of this report and then only in its entirety. Any use of the Intertek name or one of its marks for the sale or advertisement of the tested material, product or service must first be approved in writing by Intertek. The observations and test results in this report are relevant only to the sample tested. This report by itself does not imply that the material, product, or service is or has ever been under an Intertek certification program.

1 Table of Contents

	PAGE
1 Table of Contents.....	2
2 Introduction	3
3 Test Samples	3
3.1. SAMPLE SELECTION	3
3.2. SAMPLE AND ASSEMBLY DESCRIPTION	3
4 Testing and Evaluation Methods.....	4
4.1. WALL FLOOR TEST INSTALLATION	4
4.2. UNEXPOSED THERMOCOUPLE LOCATIONS.....	4
4.3. THE FIRE TEST.....	5
5 Testing and Evaluation Results.....	7
5.1. FIRE TEST OBSERVATIONS.....	7
5.2. EXAMINATION OF RESULTS	7
6 Conclusion	8
APPENDIX A – Photographs.....	2 Pages
APPENDIX B – Temperature and Pressure Data.....	4 Pages
REVISION SUMMARY	

2 Introduction

Intertek Testing Services NA Ltd. (Intertek) has conducted testing for PCL Constructors Canada Inc. on a 1-hour fire test to evaluate firestop system for a wall floor/ceiling assembly with a horizontal joint using Hilti CP606 (Red) firestop. The assembly was tested to CAN/ULC S115-11, *Standard Method of Fire Tests of Firestop Systems*.

This evaluation began October 24, 2013 and was completed on the same day.

3 Test Samples

3.1. SAMPLE SELECTION

Intertek did not select the specimen and did not verify the composition, manufacturing techniques or quality assurance procedures. The samples were received at the Evaluation Centre on October 18, 2013.

3.2. SAMPLE AND ASSEMBLY DESCRIPTION

The test assembly consisted of a 5 ply Cross Laminated Timber (CLT) wall, measuring 7 ft. wide by 6 ft. 1-1/4 in. high, and a 3 ply Cross Laminated Timber (CLT) floor/ceiling, measuring 7 ft. wide by 5 ft. 4-7/8 in. deep. A 1/2 in. gap was created between the floor and wall assembly using wood shims that were off set from the edge. The samples were fastened together using 10 in. lag screws.

A 1/2 in. thickness of "Hilti CP606 (Red)" firestop caulking was installed on both exposed and unexposed side within the annulus to a depth of 1 in.

4 Testing and Evaluation Methods

4.1. UNEXPOSED THERMOCOUPLE LOCATIONS

Unexposed surface thermocouples, as required by the Standard, were mounted on the unexposed surface to determine eligibility for T ratings. Thermocouple locations are indicated in the following table:

Thermocouple #	Thermocouple Location
1	12 in. from left side on wall assembly 1 in. from firestop interface
2	42 in. from left side on wall assembly 1 in. from firestop interface
3	12 in. from right side on wall assembly 1 in. from firestop interface
4	12 in. from left side on floor/ceiling on firestop caulking
5	42 in. from left side on floor/ceiling on firestop caulking
6	12 in. from right side on floor/ceiling assembly on firestop caulking
7	12 in. from left side on floor/ceiling 1 in. from firestop interface
8	42 in. from left side on floor/ceiling 1 in. from firestop interface
9	12 in. from right side on floor/ceiling 1 in. from firestop interface
10	12 in. from left side on floor/ceiling behind annular space
11	42 in. from left hand side of floor/ceiling behind annular space
12	12 in. from right side on floor/ceiling behind annular space
13	Centre of floor ceiling assembly

4.2. THE FIRE TEST

The test assembly was mounted on our pilot scale fire test furnace. The furnace opening for horizontal fire separations has dimensions of 70 in. in width by 44 in. in length. The furnace opening for vertical fire separations has dimensions of 70 in. in width by 56 in. in height.

Furnace temperatures are measured by six uniformly distributed thermocouples. These readings were recorded by a Yokogawa data acquisition system (ID no. WH D3593/WH D3595) recorded every 30 seconds and displayed every 15 seconds. See Appendix C – Temperature Data. The wall assembly was subjected to the standard time/temperature curve of CAN/ULC S101-07 and the unexposed surface was observed.

Furnace pressures are measured by one probe, located 12 in. below the exposed surface of the horizontal fire separation. The exhaust opening is located along the back of the furnace. Four natural gas burners are located in the furnace floor, as are four secondary air inlets. A positive pressure of 0.010 in. water column (2.5 Pa.) was maintained in the furnace. The pressure was continuously monitored throughout the test duration.

The burners were ignited and controlled to maintain furnace temperature rise to conform as closely as possible to the standard time/temperature curve. Observations, furnace temperatures, the pressure differential, and unexposed temperatures were recorded throughout the test duration.

4.3. THE HOSE STREAM TEST

The hose stream portion of this test is optional and was declined by the client.

5 Testing and Evaluation Results

5.1. FIRE TEST OBSERVATIONS

TIME (min.)	EXPOSED SIDE	UNEXPOSED SIDE
0:57	Surface ignition	
8:00	Ceiling / wall surfaces charred	
32:00	Small pieces of debris fell from wall / ceiling	
47:00	More debris fell from wall / ceiling	
49:00	Most of first layer fell away from ceiling	
84:00		Surface temp on 3 ply = 217°F
90:00*	No Change	

* At the request of the client, the test was extended to 90 minutes to collect temperature data.

5.2. EXAMINATION OF RESULTS

The following test sample achieved a 1-1/2 hour FT rating:

5 ply CLT wall system with a 3 ply CLT floor/Ceiling assembly with a ½ in. thickness of “Hilti CP606 (Red)” firestop caulking installed on the exposed and unexposed side within the annulus to a depth of 1 in.

6 Conclusion

The PCL Constructors Canada Inc. wall floor/ceiling horizontal joint assembly, as described in this report, met the following 'F' and 'T' performance ratings in accordance with CAN/ULC S115-11, *Standard Method of Fire Tests of Firestop Systems*.

Assembly	Description	'F' Rating	'T' Rating	Hose Stream
3	5 ply CLT Wall and 3 ply CLT floor ceiling assembly with a ½ in. thickness of "Hilti CP606 (Red)" firestop caulking installed on the exposed and unexposed side within the annulus to a depth of 1 in.	1-1/2 Hr.	1-1/2 Hr.	N/A

The conclusions of this test report may not be used as part of the requirements for Intertek product certification. Authority to Mark must be issued for a product to become certified.

INTERTEK TESTING SERVICES NA LTD.

Tested and
Reported by:



Dave Park
Technician – Building Products

Reviewed by:



Greg Philp
Reviewer – Fire Testing

APPENDIX A

Photographs

Unexposed Top Side Prior to the Fire Test



Exposed Side before the Fire Test



Photos Continued

After Fire Test



APPENDIX B

Temperature Data

TIME TEMPERATURE CURVE
AVERAGE TEMPERATURE (°F) OF FURNACE DURING THE FIRE TEST

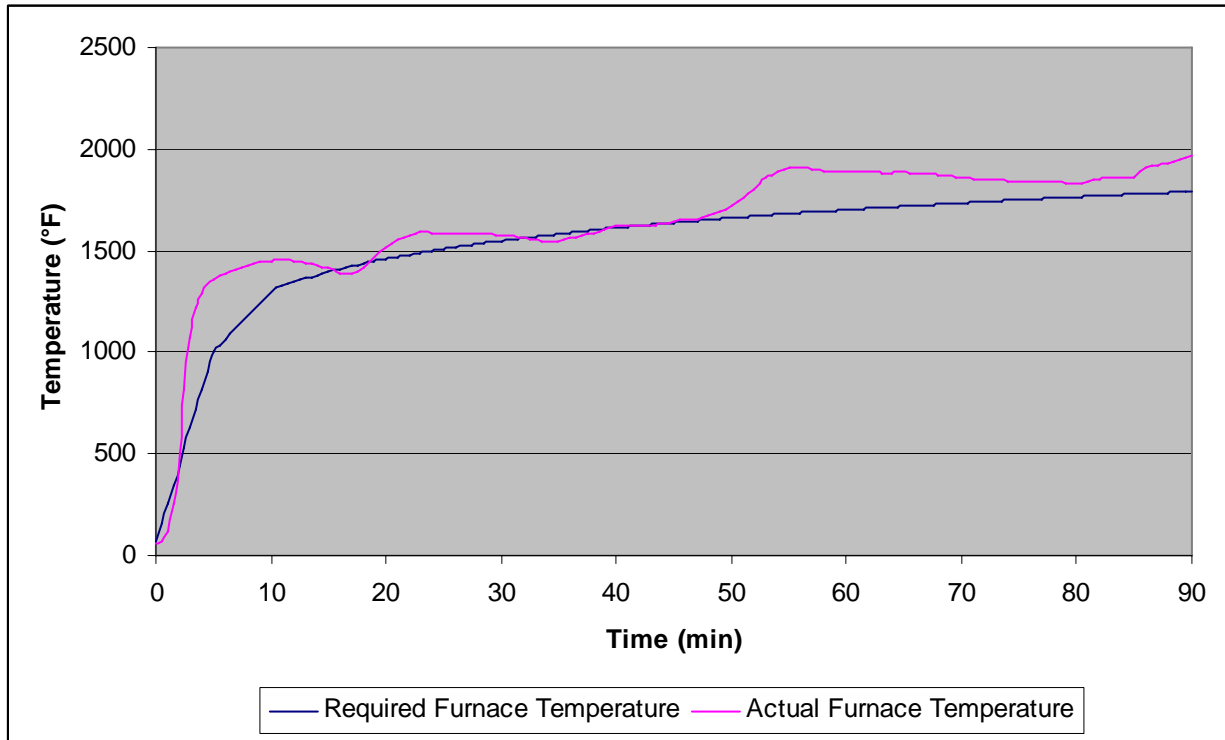

TIME PRESSURE CURVE
PRESSURE INSIDE THE FURNACE 12 IN. BELOW THE CEILING DURING THE FIRE TEST

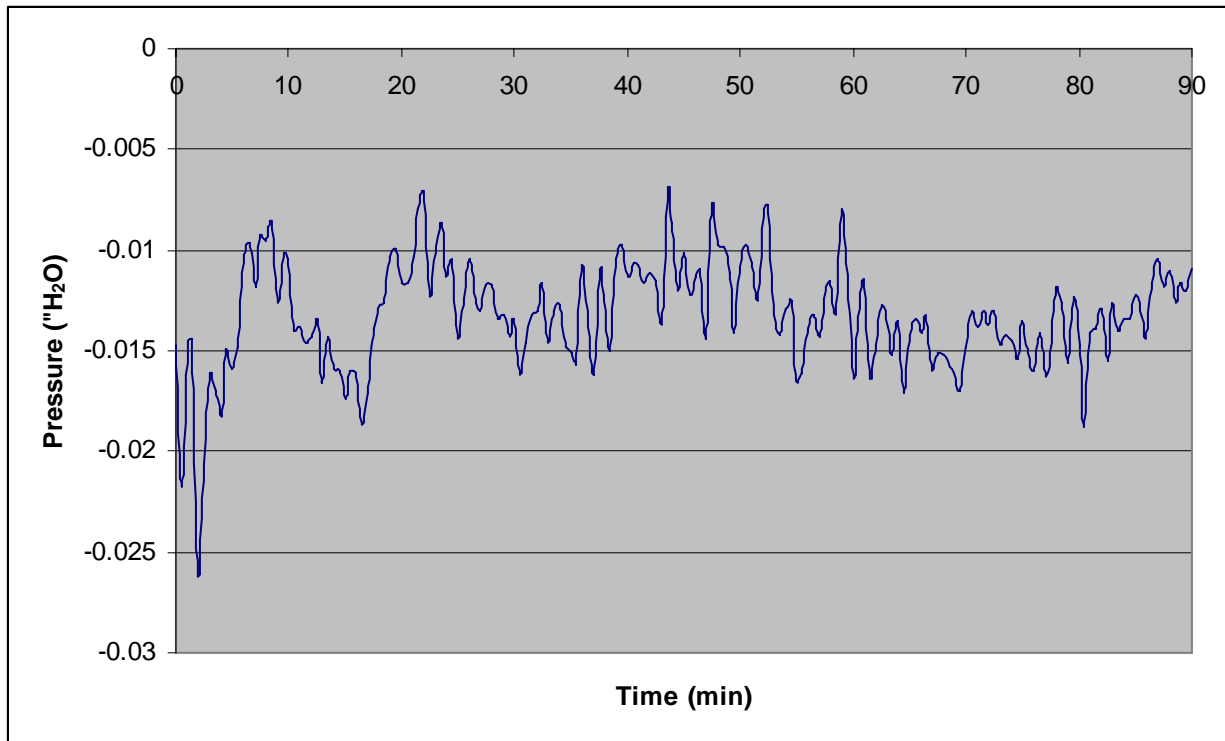

UNEXPOSED SURFACE TEMPERATURES (°F)

Time (min)	TC1	TC22	TC3	TC4	TC5	TC6	TC7	TC8	TC9	TC10	TC11	TC12	TC13
0	62	62	61	65	65	64	63	63	62	64	63	63	64
1	62	62	62	65	65	64	63	64	62	64	64	63	64
2	62	63	62	65	65	64	63	64	62	65	65	64	66
3	63	63	62	65	65	64	63	64	62	68	69	67	70
4	63	63	62	65	65	64	63	64	62	73	74	71	76
5	63	63	62	65	65	64	63	64	62	76	76	73	79
6	63	63	62	65	65	64	63	64	62	77	78	74	81
7	63	63	62	65	65	64	63	64	62	78	79	75	82
8	63	63	62	65	65	64	63	64	62	79	80	76	84
9	63	63	62	65	65	64	63	64	62	80	81	77	85
10	63	63	62	65	65	64	62	64	62	81	82	78	86
11	63	63	62	65	65	64	63	64	62	82	82	79	87
12	63	63	62	65	65	64	63	64	62	82	83	79	87
13	63	63	62	65	65	64	62	63	62	82	83	79	88
14	63	63	62	65	65	64	63	64	62	83	83	79	88
15	63	63	62	65	65	64	63	64	62	83	82	79	88
16	63	63	62	65	65	64	63	64	62	82	82	79	87
17	63	63	62	65	65	64	63	63	62	82	82	79	87
18	63	63	62	65	65	64	63	64	62	82	82	79	87
19	63	63	62	65	65	64	63	63	62	83	83	80	88
20	63	63	62	65	65	64	63	63	62	84	85	81	91
21	64	64	62	65	65	64	63	64	62	86	87	83	93
22	64	64	62	65	65	64	63	64	62	88	89	85	96
23	64	64	62	65	65	64	63	64	62	89	91	86	97
24	64	64	62	65	65	64	63	64	62	90	91	86	98
25	64	64	62	65	65	64	63	64	62	91	92	87	99
26	64	64	62	65	65	64	63	64	62	91	92	87	99
27	64	64	62	65	65	64	63	64	62	91	92	87	100
28	64	64	63	65	65	64	63	64	62	92	92	88	100
29	64	64	62	66	65	64	63	64	62	92	93	88	100
30	64	64	62	66	65	64	63	64	62	92	93	89	101
31	64	64	62	66	65	65	63	64	62	92	94	89	101
32	64	64	62	66	65	64	63	63	62	92	94	90	102
33	64	64	63	66	65	65	63	64	62	92	94	90	102
34	64	64	63	66	65	65	63	64	62	92	94	90	102
35	64	64	63	66	65	64	63	64	62	92	94	90	102
36	64	64	63	67	65	64	63	64	62	92	94	90	103
37	64	64	63	67	65	65	63	64	62	92	94	91	103
38	64	64	63	67	65	65	63	64	62	92	95	91	104
39	64	64	63	68	65	65	63	64	62	93	96	91	105
40	64	64	63	68	65	65	63	64	62	93	96	92	107
41	64	64	63	69	65	65	63	64	62	94	97	92	108
42	65	64	63	69	65	65	63	64	62	94	98	93	109
43	65	64	63	70	65	65	63	64	62	95	98	94	110

UNEXPOSED SURFACE TEMPERATURES (°F)

Continued

Time (min)	TC1	TC22	TC3	TC4	TC5	TC6	TC7	TC8	TC9	TC10	TC11	TC12	TC13
44	65	64	63	70	65	65	63	64	62	96	99	95	112
45	65	64	63	71	65	65	63	63	62	96	99	95	113
46	65	64	63	71	65	65	64	64	62	97	100	96	115
47	65	64	63	72	65	65	64	64	62	98	101	97	117
48	65	64	63	73	65	65	64	64	62	99	102	98	119
49	66	64	63	73	65	66	64	64	62	101	106	101	123
50	66	64	63	73	65	66	64	64	62	104	109	104	128
51	66	65	63	74	65	66	64	64	62	107	114	108	134
52	66	65	63	74	65	66	63	64	62	111	119	112	141
53	67	65	64	75	66	67	64	64	62	116	124	116	147
54	67	65	64	76	66	67	64	64	62	120	128	120	153
55	68	65	64	76	66	68	64	64	62	125	128	124	159
56	68	66	64	77	66	68	64	64	62	128	134	127	164
57	69	66	64	77	66	69	64	64	62	133	138	130	170
58	69	66	65	78	66	69	64	64	63	134	140	131	172
59	69	66	65	78	67	69	64	64	63	135	142	133	175
60	70	67	65	79	67	70	65	64	63	136	141	133	174
61	70	67	65	79	67	70	65	64	63	137	143	134	176
62	70	67	66	80	68	71	65	65	63	138	145	135	178
63	70	67	66	80	68	71	65	65	63	139	146	135	179
64	70	67	66	81	68	72	65	65	63	139	146	135	180
65	70	67	66	81	69	72	65	65	63	139	147	136	182
66	70	67	66	81	69	73	65	64	63	140	148	136	184
67	71	67	66	82	69	73	65	65	64	140	149	137	185
68	71	67	67	82	69	74	65	65	64	140	149	137	186
69	71	68	67	83	70	74	65	65	64	140	148	137	187
70	71	68	67	83	70	74	65	65	64	139	147	136	188
71	71	68	67	84	71	75	66	65	64	138	146	136	188
72	72	68	67	84	71	76	66	65	64	137	146	136	189
73	72	68	67	85	72	76	66	65	64	137	146	135	190
74	72	68	68	85	72	77	66	65	64	137	146	135	191
75	72	69	68	85	73	77	66	65	64	136	146	135	192
76	73	69	68	85	73	78	66	65	64	136	145	135	194
77	73	69	68	86	73	78	66	65	64	136	145	135	196
78	73	69	69	86	74	79	66	65	65	135	144	134	198
79	73	69	69	86	74	79	66	65	65	135	144	134	200
80	73	69	69	87	74	80	67	65	65	134	143	134	203
81	73	70	69	87	75	81	67	66	65	134	143	133	207
82	73	70	70	87	76	82	67	66	65	134	144	133	212
83	74	70	70	87	76	82	67	66	65	134	145	134	217
84	74	70	70	87	76	83	67	66	65	134	144	134	222
85	74	71	70	88	77	83	67	66	66	135	145	134	227
86	74	71	71	88	78	84	67	66	66	135	146	135	232
87	74	71	71	88	78	85	67	67	66	137	148	137	238
88	75	72	71	88	79	85	67	66	65	139	151	139	245
89	75	72	72	89	79	86	67	67	66	142	155	141	252
90	75	73	72	89	80	87	67	67	66	145	157	143	260

REVISION SUMMARY

DATE	PAGE	SUMMARY	INITIAL
November 21, 2013	--	Original Issue Date	--
February 24, 2014	6, 7	Updated FT Rating to 1-1/2 hour	

Appendix IV

Intertek Report Number 101341829COQ-003D (Nov. 2013)



REPORT NUMBER: 101341829COQ-003D
ORIGINAL ISSUE DATE: November 26, 2013

EVALUATION CENTER
Intertek Testing Services NA Ltd.
1500 Brigantine Drive
Coquitlam, B.C. V3K 7C1

RENDERED TO

PCL Constructors Canada Inc.
13911 Wireless Way, Suite 310
Richmond, B.C. V6V 3A4

PRODUCT EVALUATED: Horizontal Joint Firestop System
EVALUATION PROPERTY: Fire Resistance

Report of Testing Horizontal Joint Firestop System for compliance with the applicable requirements of the following criteria: CAN/ULC S115-11, Standard Method of Fire Tests of Firestop Systems.

This report is for the exclusive use of Intertek's Client and is provided pursuant to the agreement between Intertek and its Client. Intertek's responsibility and liability are limited to the terms and conditions of the agreement. Intertek assumes no liability to any party, other than to the Client in accordance with the agreement, for any loss, expense or damage occasioned by the use of this report. Only the Client is authorized to permit copying or distribution of this report and then only in its entirety. Any use of the Intertek name or one of its marks for the sale or advertisement of the tested material, product or service must first be approved in writing by Intertek. The observations and test results in this report are relevant only to the sample tested. This report by itself does not imply that the material, product, or service is or has ever been under an Intertek certification program.

TEST REPORT

1 Table of Contents

	PAGE
1 Table of Contents	2
2 Introduction	3
3 Test Samples	3
3.1. SAMPLE SELECTION	3
3.2. SAMPLE AND ASSEMBLY DESCRIPTION	3
4 Testing and Evaluation Methods.....	4
4.1. UNEXPOSED THERMOCOUPLE LOCATIONS.....	4
4.2. THE FIRE TEST	5
4.3. THE HOSE STREAM TEST	5
5 Testing and Evaluation Results	6
5.1. FIRE TEST OBSERVATIONS	6
5.2. EXAMINATION OF RESULTS.....	6
6 Conclusion	7
APPENDIX A – Photographs	2 Pages
APPENDIX B – Temperature and Pressure Data.....	6 Pages
REVISION SUMMARY	

2 Introduction

Intertek Testing Services NA Ltd. (Intertek) has conducted testing for PCL Constructors Canada Inc. on a 2-hour fire test to evaluate firestop system for floor transition horizontal joints using Hannobond tape on one side and Manus Bond caulking on other side. The assembly was tested to CAN/ULC S115-11, *Standard Method of Fire Tests of Firestop Systems*.

This evaluation began October 23, 2013 and was completed on the same day.

3 Test Samples

3.1. SAMPLE SELECTION

Intertek did not select the specimen and did not verify the composition, manufacturing techniques or quality assurance procedures. The samples were received at the Evaluation Centre on October 18, 2013.

3.2. SAMPLE AND ASSEMBLY DESCRIPTION

The test assembly consisted of two 5 ply Cross Laminated Timber (CLT) floors measuring 7 ft. wide by 1 ft. 5 in. deep and a 3 ply Cross Laminated Timber (CLT) floor transition measuring 7 ft. wide by 2 ft. 4 in. deep. The samples were fastened together using 6 in. lag screws.

Hannobond tape was used on one side of the transition and Manus Bond caulking on the other side. There was no discernable gap between the 5 ply floors and the 3 ply transition.

4 Testing and Evaluation Methods

4.1. UNEXPOSED THERMOCOUPLE LOCATIONS

Unexposed surface thermocouples, as required by the Standard, were mounted on the unexposed surface to determine eligibility for T ratings. Thermocouple locations are indicated in the following table:

Thermocouple #	Thermocouple Location
1	12 in. from left side 1 in. from Hannobond tape joint on 5 ply CLT
2	42 in. from left side 1 in. from Hannobond tape joint on 5 ply CLT
3	12 in. from right side 1 in. from Hannobond tape joint on 5 ply CLT
4	12 in. from left side on Hannobond tape joint
5	42 in. from left side on Hannobond tape joint
6	12 in. from right side on Hannobond tape joint
7	12 in. from left side 1 in. from Hannobond tape joint on 3 ply CLT transition
8	42 in. from left side 1 in. from Hannobond tape joint on 3 ply CLT transition
9	12 in. from right side 1 in. from Hannobond tape joint on 3 ply CLT transition
10	12 in. from left side 1 in. from Manus Bond caulking joint on 5 ply CLT
11	42 in. from left side 1 in. from Manus Bond caulking joint on 5 ply CLT
12	12 in. from right side 1 in. from Manus Bond caulking joint on 5 ply CLT
13	12 in. from left side on Manus Bond caulking joint
14	42 in. from left side on Manus Bond caulking joint
15	12 in. from right side on Manus Bond caulking joint
16	12 in. from left side 1 in. from Manus Bond caulking joint on 3 ply CLT transition
17	42 in. from left side 1 in. from Manus Bond caulking joint on 3 ply CLT transition
18	12 in. from right side 1 in. from Manus Bond caulking joint on 3 ply CLT Transition
19	Center of 3 ply CLT transition

4.2. THE FIRE TEST

The test assembly was mounted on our pilot scale fire test furnace. The furnace opening for horizontal fire separations has dimensions of 70 in. in width by 44 in. in length.

Furnace temperatures are measured by six uniformly distributed thermocouples. These readings were recorded by a Yokogawa data acquisition system (ID no. WH D3593/WH D3595) recorded every 30 seconds and displayed every 15 seconds. See Appendix C – Temperature Data. The wall assembly was subjected to the standard time/temperature curve of CAN/ULC S101-07 and the unexposed surface was observed.

Furnace pressures are measured by one probe, located 12 in. below the exposed surface of the horizontal fire separation. The exhaust opening is located along the back of the furnace. Four natural gas burners are located in the furnace floor, as are four secondary air inlets. A positive pressure of 0.010 in. water column (2.5 Pa.) was maintained in the furnace. The pressure was continuously monitored throughout the test duration.

The burners were ignited and controlled to maintain furnace temperature rise to conform as closely as possible to the standard time/temperature curve. Observations, furnace temperatures, the pressure differential, and unexposed temperatures were recorded throughout the test duration.

4.3. THE HOSE STREAM TEST

The hose stream portion of this test is optional and was declined by the client.

5 Testing and Evaluation Results

5.1. FIRE TEST OBSERVATIONS

TIME (min.)	EXPOSED SIDE	UNEXPOSED SIDE
0:52	Surface ignition	
22:00	Surface continued to burn	No change
58:00	Char fell away	
60:00		TC11 = 136°F; caulk joint at centre 1 in. above
64:00	Surface ignition continued	
111:00		Pinhole at joint
120:00	Test Discontinued	

5.2. EXAMINATION OF RESULTS

The following test sample achieved a 2-hour FT rating:

Two 5 ply CLT floor system and 3 ply CLT transition, with Hannobond tape used on one side and Manus Bond caulking on the other side.

6 Conclusion

The PCL Constructors Canada Inc. floor transition assembly, as described in this report, met the following 'F' and 'T' ratings in accordance with CAN/ULC S115-11, *Standard Method of Fire Tests of Firestop Systems*.

Assembly	Description	'F' Rating	'T' Rating	Hose Stream
4	Two 5 ply CLT floor system and 3 ply CLT transition, with Hannobond tape used on one side and Manus Bond caulking on the other side	2 Hr.	2 Hr.	N/A

The conclusions of this test report may not be used as part of the requirements for Intertek product certification. Authority to Mark must be issued for a product to become certified.

INTERTEK TESTING SERVICES NA LTD.

Tested and
Reported by:



Dave Park
Technician – Building Products

Reviewed by:



Greg Philp
Reviewer – Fire Testing

APPENDIX A

Photographs



Unexposed Top Side Prior to the Fire Test



Exposed Side After the Fire Test



Exposed Side After the Fire Test

APPENDIX B

Temperature Data

TIME TEMPERATURE CURVE
AVERAGE TEMPERATURE (°F) OF FURNACE DURING THE FIRE TEST

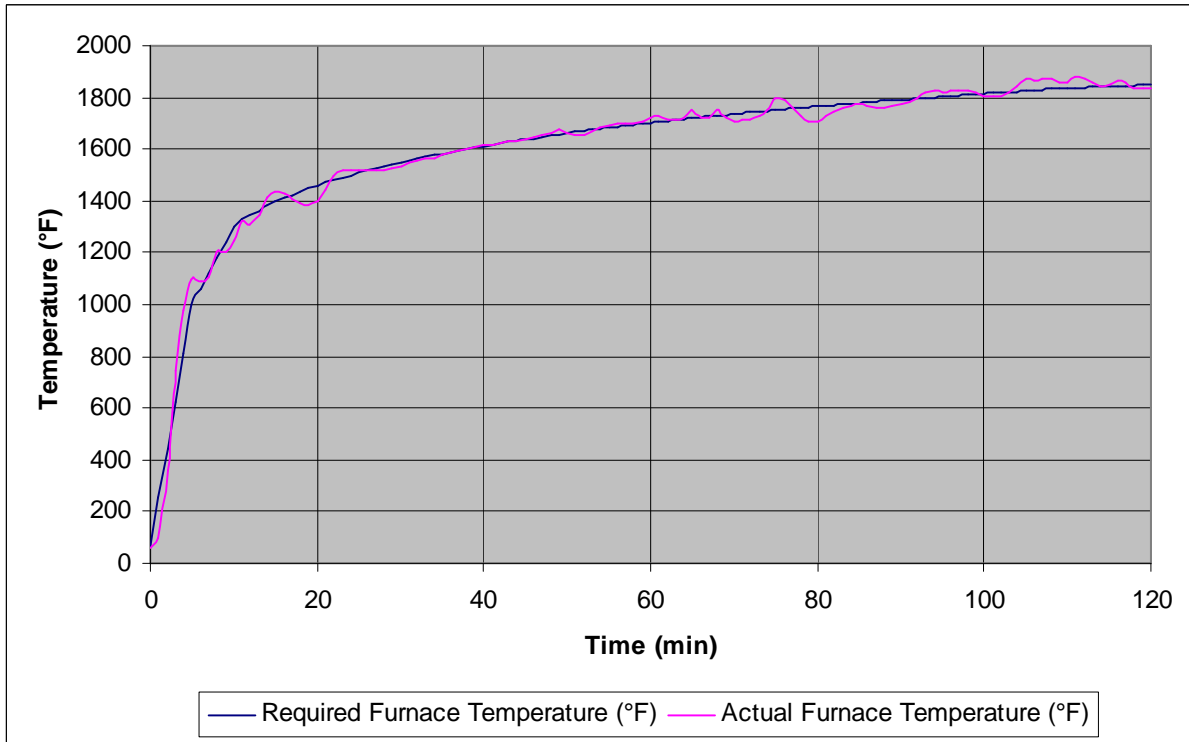

TIME PRESSURE CURVE
PRESSURE INSIDE THE FURNACE 12 IN. BELOW THE CEILING DURING THE FIRE TEST

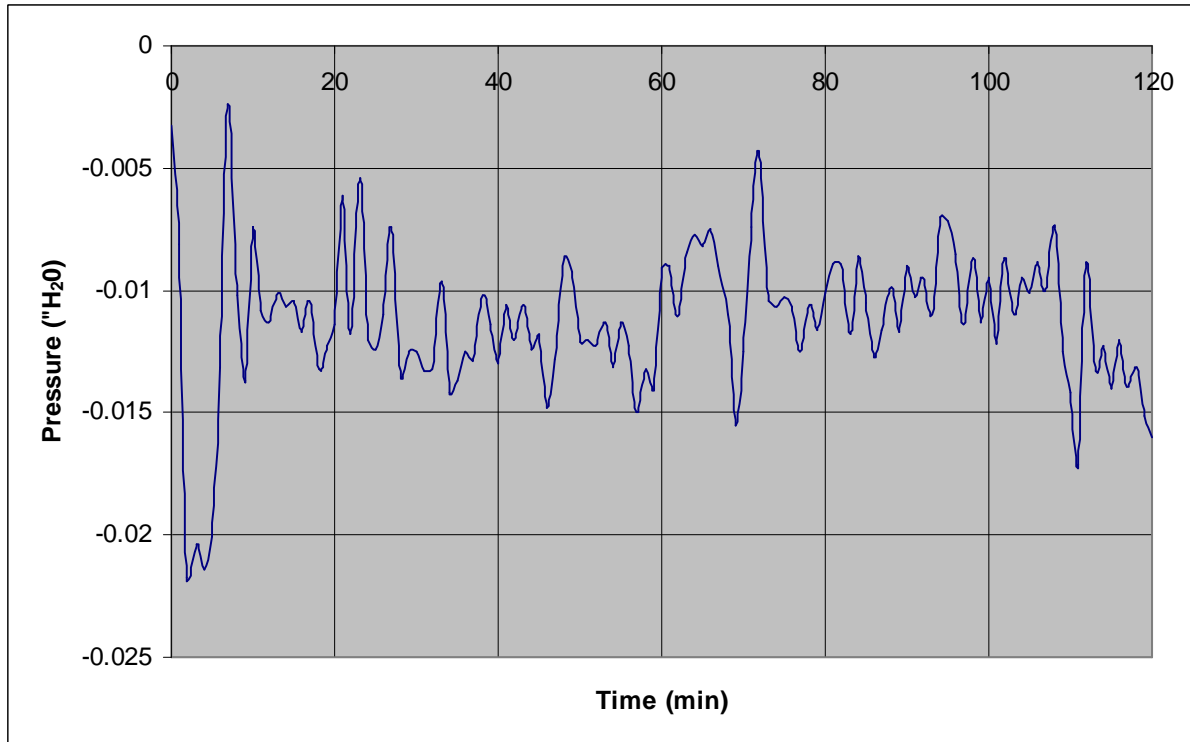

UNEXPOSED SURFACE TEMPERATURES (°F)

Time (min)	TC1	TC2	TC3	TC4	TC5	TC6	TC7	TC8	TC9	TC10	TC11	TC12	TC13	TC14	TC15	TC16	TC17	TC18	TC19
0	61	62	61	63	63	63	61	62	61	61	60	61	62	62	62	60	60	65	60
1	63	63	62	64	64	63	63	63	62	61	62	62	62	62	63	61	60	64	62
2	62	63	62	64	64	63	62	62	62	64	66	65	63	63	64	62	61	62	68
3	62	63	62	64	64	64	62	63	62	67	72	71	65	65	66	64	63	61	74
4	63	64	62	64	64	64	62	63	62	69	73	72	66	66	67	64	63	60	74
5	63	64	62	64	64	64	62	63	62	69	74	73	66	66	68	65	64	60	75
6	62	64	62	64	64	63	62	63	62	68	71	72	66	66	68	64	63	60	72
7	62	64	62	64	64	64	62	63	62	68	71	71	66	66	67	64	63	60	72
8	63	64	62	64	64	63	62	63	62	70	75	74	67	67	69	65	64	58	77
9	63	64	62	64	64	64	62	63	62	71	75	75	67	67	69	65	64	58	76
10	63	64	62	64	64	64	62	63	62	71	76	75	68	68	69	66	65	58	77
11	63	65	63	64	64	64	62	64	62	73	79	77	69	69	70	67	66	57	81
12	64	65	63	64	64	64	62	64	62	74	79	78	69	69	71	67	66	57	80
13	63	65	63	64	64	64	62	64	62	74	79	78	69	69	71	67	66	57	81
14	64	65	63	64	65	64	62	64	62	76	82	80	70	71	72	68	67	56	84
15	64	65	63	64	65	64	63	64	62	77	84	82	71	72	73	69	69	55	86
16	64	65	63	64	65	64	63	64	62	78	85	83	72	72	73	69	69	55	86
17	64	66	64	64	65	64	63	64	62	78	85	83	72	73	74	69	69	55	86
18	65	66	64	65	65	64	63	64	62	78	85	83	73	73	74	69	70	55	86
19	64	66	64	65	65	64	63	64	62	78	85	83	73	73	74	70	71	55	85
20	65	66	64	65	65	64	63	64	62	78	85	82	73	74	74	70	71	55	85
21	65	66	64	65	65	64	63	64	62	79	87	83	73	74	74	70	71	55	87
22	65	66	64	65	65	64	63	64	62	81	89	85	74	75	75	71	73	55	89
23	65	66	64	65	65	64	64	65	62	82	91	86	75	76	76	72	74	55	91
24	65	67	64	65	65	65	64	65	62	83	92	87	75	77	76	72	74	55	91
25	65	67	64	65	65	65	64	65	62	83	92	88	76	78	77	73	75	54	92
26	65	67	64	65	66	65	64	65	62	84	93	89	76	79	77	73	76	54	92
27	65	67	65	65	66	65	64	65	62	84	94	89	76	79	78	73	77	54	93
28	66	67	65	65	66	65	64	65	63	85	95	89	77	80	78	73	78	54	94
29	66	68	65	65	66	65	64	65	63	85	96	90	77	81	78	74	79	54	94
30	66	68	65	65	66	65	64	66	63	86	97	91	78	82	79	74	80	53	95

UNEXPOSED SURFACE TEMPERATURES (°F) - *Continued*

Time (min)	TC1	TC2	TC3	TC4	TC5	TC6	TC7	TC8	TC9	TC10	TC11	TC12	TC13	TC14	TC15	TC16	TC17	TC18	TC19
31	66	68	65	65	66	65	64	66	63	86	98	91	78	82	79	74	81	53	96
32	66	68	65	65	66	65	64	66	63	87	99	92	78	83	80	75	82	53	96
33	66	68	65	65	66	65	64	66	63	87	100	93	79	84	80	75	83	52	97
34	66	68	65	65	66	65	64	66	63	88	102	93	79	85	81	76	85	52	97
35	66	68	65	66	66	65	64	66	63	88	102	93	80	86	81	76	85	52	98
36	66	68	65	66	66	65	64	66	63	88	103	94	80	86	81	76	86	52	98
37	66	69	65	66	67	65	64	67	63	89	104	94	80	87	81	77	87	52	99
38	66	69	66	66	67	65	65	67	63	90	105	95	81	88	82	77	88	52	100
39	66	69	66	66	67	65	64	67	63	90	106	96	81	89	82	78	89	51	100
40	67	69	66	66	67	65	65	67	64	91	108	96	82	90	83	77	92	51	100
41	66	69	66	66	67	65	64	67	64	91	108	96	82	91	83	78	92	51	101
42	67	70	66	65	67	65	65	68	64	91	109	96	82	92	83	78	92	51	99
43	67	70	66	66	67	65	65	67	64	92	108	97	82	91	83	78	89	51	101
44	67	70	66	66	67	65	65	67	64	92	108	98	83	91	84	79	89	51	103
45	67	70	66	66	67	66	65	68	64	92	108	98	83	91	84	79	89	50	104
46	67	70	66	66	67	66	65	68	64	93	109	99	83	92	85	79	90	51	105
47	67	70	66	66	67	66	65	67	64	93	110	99	84	92	85	80	90	50	105
48	68	70	66	67	67	66	65	68	64	94	110	100	84	93	85	80	91	50	107
49	68	70	67	66	67	66	65	68	64	94	112	101	85	93	86	81	91	49	107
50	68	71	66	67	68	66	65	68	64	95	112	101	85	94	86	81	92	49	108
51	68	70	66	67	68	66	65	68	64	95	113	101	85	95	86	81	93	49	106
52	68	70	66	67	68	66	66	68	64	95	112	101	85	95	86	81	93	49	107
53	68	71	67	67	68	66	66	68	64	96	114	102	86	96	87	82	94	49	108
54	68	71	67	67	68	66	65	68	64	97	115	102	86	96	87	82	95	49	110
55	68	71	67	67	68	66	66	68	64	97	115	103	87	97	87	83	96	49	110
56	68	71	67	67	68	66	66	69	64	97	117	103	87	98	88	83	97	49	112
57	68	72	67	67	68	66	66	69	64	98	118	104	88	98	88	83	98	48	113
58	68	72	67	67	68	66	66	69	64	98	119	105	88	99	89	84	98	49	114
59	69	72	67	67	68	66	66	69	64	100	120	106	89	100	89	85	99	48	115
60	69	73	67	67	69	66	66	69	64	101	122	107	89	101	90	85	100	48	118

UNEXPOSED SURFACE TEMPERATURES (°F) - *Continued*

Time (min)	TC1	TC2	TC3	TC4	TC5	TC6	TC7	TC8	TC9	TC10	TC11	TC12	TC13	TC14	TC15	TC16	TC17	TC18	TC19
61	69	72	67	67	69	66	66	69	65	101	124	109	90	102	91	86	102	47	120
62	69	73	67	67	69	66	66	70	65	103	127	111	91	103	92	86	104	46	122
63	69	73	68	67	69	66	66	70	65	103	128	111	92	105	92	87	105	46	123
64	69	73	68	67	69	67	66	70	65	104	128	112	92	105	93	88	106	46	124
65	69	74	68	67	69	67	67	71	65	105	130	113	93	107	93	88	107	46	126
66	69	74	68	67	69	67	67	71	65	107	131	113	94	107	94	89	108	45	127
67	70	74	68	68	69	67	67	71	66	107	131	113	94	108	94	90	109	45	127
68	70	74	68	68	70	67	67	71	66	108	132	114	95	109	95	90	109	46	129
69	70	74	68	68	70	67	67	71	66	109	133	115	95	110	95	91	111	45	131
70	70	74	69	68	70	67	67	71	66	109	134	115	96	111	96	91	111	45	131
71	70	74	69	68	70	67	67	71	66	109	135	115	96	112	96	92	113	45	132
72	70	74	68	68	70	67	67	71	66	110	136	116	97	113	96	92	114	45	133
73	71	75	69	68	70	67	68	72	66	110	137	116	97	114	97	92	115	45	134
74	71	75	69	68	70	67	68	72	66	110	138	117	98	115	97	93	116	45	136
75	71	75	69	69	70	68	68	72	66	111	140	118	98	116	98	93	118	44	137
76	71	76	69	69	70	67	68	72	66	112	141	119	99	117	98	94	118	44	139
77	71	76	69	69	71	68	68	73	67	113	142	119	99	118	99	94	120	45	140
78	71	75	69	69	71	68	68	72	66	113	143	119	100	119	99	95	121	44	140
79	72	76	69	69	71	68	69	73	67	113	144	119	100	120	100	95	123	44	141
80	71	76	69	69	71	68	68	73	67	113	144	119	100	121	100	94	124	44	141
81	72	76	69	69	71	68	69	73	67	113	145	119	100	122	100	95	125	44	142
82	71	76	69	69	71	68	68	73	67	113	145	119	100	122	100	96	125	44	143
83	72	76	69	69	71	68	69	73	67	114	146	119	101	123	100	96	126	44	144
84	72	76	69	69	71	68	69	73	67	114	148	121	101	125	101	97	128	43	146
85	73	76	69	69	71	68	69	73	67	114	149	121	101	126	101	96	129	43	148
86	72	76	69	69	71	68	69	73	67	115	150	122	102	127	101	97	131	43	149
87	73	77	69	70	72	68	70	73	67	115	151	122	102	128	102	97	132	43	152
88	73	77	70	70	72	68	70	73	67	116	152	123	103	129	102	98	134	42	154
89	73	77	70	70	72	68	70	74	67	116	154	124	103	130	103	98	136	42	156
90	73	77	71	70	72	69	70	74	68	116	155	124	103	130	103	98	137	42	159

UNEXPOSED SURFACE TEMPERATURES (°F) - *Continued*

Time (min)	TC1	TC2	TC3	TC4	TC5	TC6	TC7	TC8	TC9	TC10	TC11	TC12	TC13	TC14	TC15	TC16	TC17	TC18	TC19
91	73	77	70	70	72	69	70	74	68	117	156	124	104	131	104	98	138	42	162
92	74	78	70	71	72	69	70	74	68	117	156	125	104	132	104	98	139	42	166
93	74	78	70	71	73	69	70	75	68	118	157	125	105	133	105	99	140	41	170
94	73	79	70	70	73	69	70	75	68	118	158	126	105	134	105	99	142	41	174
95	74	79	70	71	73	69	70	75	68	119	159	127	106	135	106	100	144	41	177
96	74	78	70	71	73	69	70	75	68	119	155	127	106	135	106	101	140	41	179
97	74	78	70	71	73	69	71	75	68	120	151	127	106	131	106	101	135	41	184
98	74	78	71	71	73	69	71	74	68	120	148	127	107	129	106	101	134	42	188
99	74	78	71	71	73	69	71	74	68	120	147	127	107	128	106	101	134	42	191
100	74	78	71	71	73	69	71	74	68	120	146	127	107	128	106	102	134	41	194
101	74	78	71	71	73	69	71	75	68	121	146	128	108	128	107	102	135	41	196
102	75	78	71	71	73	69	71	74	68	121	145	127	108	127	107	102	135	41	198
103	75	78	71	72	73	69	72	75	68	121	144	128	108	127	107	102	135	41	200
104	76	78	71	72	74	69	72	75	68	121	145	128	109	127	108	103	137	41	202
105	76	79	71	72	74	69	73	75	69	122	146	129	109	128	108	103	138	41	205
106	76	79	71	73	74	70	72	76	69	124	146	130	110	128	109	105	139	40	208
107	76	79	71	73	74	70	73	76	69	124	147	132	110	129	110	105	140	39	210
108	76	80	72	73	74	70	73	76	69	125	147	132	111	129	110	106	141	39	212
109	76	81	72	73	75	70	72	77	69	125	146	132	112	129	110	106	141	40	213
110	76	80	72	73	75	70	72	77	69	126	147	132	112	130	111	107	141	40	214
111	76	80	72	73	75	70	73	77	70	126	147	133	112	130	111	107	143	39	216
112	76	81	73	73	76	71	73	77	70	127	148	134	113	130	112	107	143	38	219
113	76	81	73	73	76	71	73	77	70	127	148	135	113	131	112	108	145	38	221
114	76	81	72	73	76	71	73	77	70	128	148	135	114	131	113	108	146	38	223
115	76	81	73	73	76	71	73	77	70	128	149	135	114	132	113	109	146	37	225
116	76	82	73	73	76	71	73	78	70	128	150	135	115	132	113	109	148	37	229
117	77	82	73	73	76	71	73	78	70	129	150	136	115	133	114	109	148	37	232
118	77	82	73	74	76	71	73	78	71	128	150	136	115	133	114	109	149	37	235
119	77	82	73	74	77	71	74	78	71	128	150	136	115	134	114	109	149	36	238
120	78	82	73	74	77	71	74	78	71	129	150	136	116	135	115	110	150	36	242

REVISION SUMMARY

DATE	PAGE	SUMMARY	INITIAL
November 26, 2013	--	Original Issue Date	

Appendix V

Intertek Report Number 101341829COQ-003E (Nov. 2013)



REPORT NUMBER: 101341829COQ-003E
ORIGINAL ISSUE DATE: November 26, 2013

EVALUATION CENTER
Intertek Testing Services NA Ltd.
1500 Brigantine Drive
Coquitlam, B.C. V3K 7C1

RENDERED TO

PCL Constructors Canada Inc.
13911 Wireless Way, Suite 310
Richmond, B.C. V6V 3A4

PRODUCT EVALUATED: Horizontal Joint Firestop System
EVALUATION PROPERTY: Fire Resistance

Report of Testing Horizontal Joint Firestop System for compliance with the applicable requirements of the following criteria: CAN/ULC S115-11, *Standard Method of Fire Tests of Firestop Systems.*

This report is for the exclusive use of Intertek's Client and is provided pursuant to the agreement between Intertek and its Client. Intertek's responsibility and liability are limited to the terms and conditions of the agreement. Intertek assumes no liability to any party, other than to the Client in accordance with the agreement, for any loss, expense or damage occasioned by the use of this report. Only the Client is authorized to permit copying or distribution of this report and then only in its entirety. Any use of the Intertek name or one of its marks for the sale or advertisement of the tested material, product or service must first be approved in writing by Intertek. The observations and test results in this report are relevant only to the sample tested. This report by itself does not imply that the material, product, or service is or has ever been under an Intertek certification program.

TEST REPORT

1 Table of Contents

	PAGE
Table of Contents.....	2
2 Introduction	3
3 Test Samples	3
3.1. SAMPLE SELECTION.....	3
3.2. SAMPLE AND ASSEMBLY DESCRIPTION	3
4 Testing and Evaluation Methods.....	4
4.1. UNEXPOSED THERMOCOUPLE LOCATIONS.....	4
4.2. THE FIRE TEST	5
4.3. THE HOSE STREAM TEST	5
5 Testing and Evaluation Results	6
5.1. FIRE TEST OBSERVATIONS	6
5.2. EXAMINATION OF RESULTS.....	6
6 Conclusion	7
APPENDIX A – Photographs	2 Pages
APPENDIX B – Temperature and Pressure Data.....	6 Pages
REVISION SUMMARY	

2 Introduction

Intertek Testing Services NA Ltd. (Intertek) has conducted testing for PCL Constructors Canada Inc. on a 1-hour fire test to evaluate firestop system for stair horizontal joints using Hannobond tape in a routed groove and Manus Bond caulking at bottom. The assembly was tested to CAN/ULC S115-11, *Standard Method of Fire Tests of Firestop Systems*.

This evaluation began October 23, 2013 and was completed on the same day.

3 Test Samples

3.1. SAMPLE SELECTION

Intertek did not select the specimen and did not verify the composition, manufacturing techniques or quality assurance procedures. The samples were received at the Evaluation Centre on October 18, 2013.

3.2. SAMPLE AND ASSEMBLY DESCRIPTION

The test assembly consisted of a top landing measuring 7 ft. wide by 1 ft. 3-3/8 in. deep and a bottom landing measuring 7 ft. wide by 1 ft. 3-5/16 in. deep, connected by a stringer. The total depth of the assembly was 3 ft. 10 in. The samples were fastened together using 6 in. lag screws.

Hannobond tape was used between the top landing and the stringer in the routed groove. Manus Bond caulking was used between the bottom landing and the stringer at the bottom.

4 Testing and Evaluation Methods

4.1. UNEXPOSED THERMOCOUPLE LOCATIONS

Unexposed surface thermocouples, as required by the Standard, were mounted on the unexposed surface to determine eligibility for T ratings. Thermocouple locations are indicated in the following table:

Thermocouple #	Thermocouple Location
1	12 in. from left side 1 in. from Manus Bond caulking joint on Landing
2	42 in. from left side 1 in. from Manus Bond caulking joint on Landing
3	12 in. from right side 1 in. from Manus Bond caulking joint on Landing
4	12 in. from left side on Manus Bond caulking joint
5	42 in. from left side on Manus Bond caulking joint
6	12 in. from right side on Manus Bond caulking joint
7	12 in. from left side 1 in. from Manus Bond caulking joint on Riser
8	42 in. from left side 1 in. from Manus Bond caulking joint on Riser
9	12 in. from right side 1 in. from Manus Bond caulking joint on Riser
10	12 in. from left side 1 in. from Hannobond tape joint on Riser
11	42 in. from left side 1 in. from Hannobond tape joint on Riser
12	12 in. from right side 1 in. from Hannobond tape joint on Riser
13	12 in. from left side on Hannobond tape joint
14	42 in. from left side on Hannobond tape joint
15	12 in. from right side on Hannobond tape joint
16	12 in. from left side 1 in. from Hannobond tape joint on upper Landing
17	42 in. from left side 1 in. from Hannobond tape joint on upper Landing
18	12 in. from right side 1 in. from Hannobond tape joint on upper Landing
19	Center of Riser

4.2. THE FIRE TEST

The test assembly was mounted on our pilot scale fire test furnace. The furnace opening for horizontal fire separations has dimensions of 70 in. in width by 44 in. in length.

Furnace temperatures are measured by six uniformly distributed thermocouples. These readings were recorded by a Yokogawa data acquisition system (ID no. WH D3593/WH D3595) recorded every 30 seconds and displayed every 15 seconds. See Appendix C – Temperature Data. The wall assembly was subjected to the standard time/temperature curve of CAN/ULC S101-07 and the unexposed surface was observed.

Furnace pressures are measured by one probe, located 12 in. below the exposed surface of the horizontal fire separation. The exhaust opening is located along the back of the furnace. Four natural gas burners are located in the furnace floor, as are four secondary air inlets. A positive pressure of 0.010 in. water column (2.5 Pa.) was maintained in the furnace. The pressure was continuously monitored throughout the test duration.

The burners were ignited and controlled to maintain furnace temperature rise to conform as closely as possible to the standard time/temperature curve. Observations, furnace temperatures, the pressure differential, and unexposed temperatures were recorded throughout the test duration.

4.3. THE HOSE STREAM TEST

The hose stream portion of this test is optional and was declined by the client.

5 Testing and Evaluation Results

5.1. FIRE TEST OBSERVATIONS

TIME (min.)	EXPOSED SIDE	UNEXPOSED SIDE
1:00	Surface ignition	
57:00	Debris from ceiling fell	No change
90:00		144°F centre back
120:00	Test Discontinued	

5.2. EXAMINATION OF RESULTS

The following test sample achieved a 2-hour FT rating:

Stair assembly with Hannobond tape used between top landing and stringer in the routed groove and Manus Bond caulking between bottom landing and stringer at bottom.

6 Conclusion

The PCL Constructors Canada Inc. stair assembly, as described in this report, met the following 'F' and 'T' ratings in accordance with CAN/ULC S115-11, *Standard Method of Fire Tests of Firestop Systems*.

Assembly	Description	'F' Rating	'T' Rating	Hose Stream
5	Stair assembly with Hannobond tape used between top landing and stringer in the routed groove and Manus Bond caulking between bottom landing and stringer at bottom.	2 Hr.	2 Hr.	N/A

The conclusions of this test report may not be used as part of the requirements for Intertek product certification. Authority to Mark must be issued for a product to become certified.

INTERTEK TESTING SERVICES NA LTD.

Tested and
Reported by:



Dave Park
Technician – Building Products

Reviewed by:



Greg Philp
Reviewer – Fire Testing

APPENDIX A

Photographs



Unexposed Top Side Prior to the Fire Test



Exposed Side Prior to the Fire Test



Exposed Side After the Fire Test

APPENDIX B

Temperature Data

TIME TEMPERATURE CURVE
AVERAGE TEMPERATURE (°F) OF FURNACE DURING THE FIRE TEST

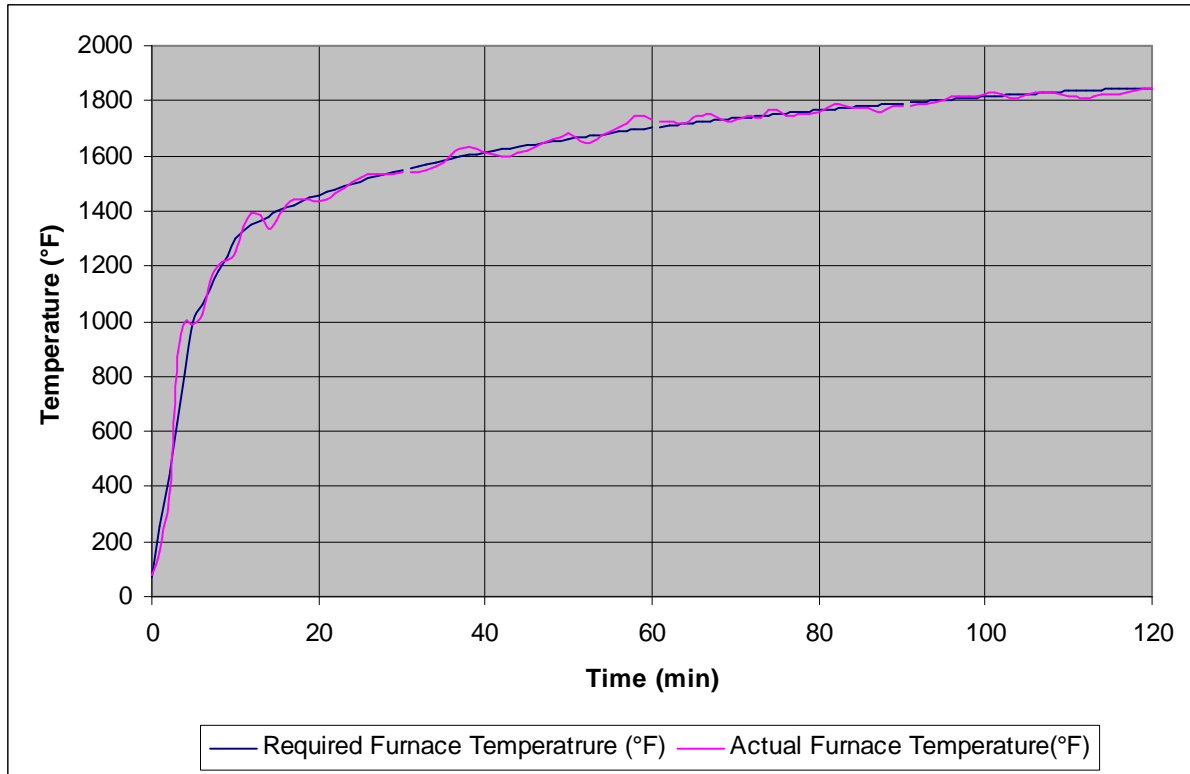

TIME PRESSURE CURVE
PRESSURE INSIDE THE FURNACE 12 IN. BELOW THE CEILING DURING THE FIRE TEST

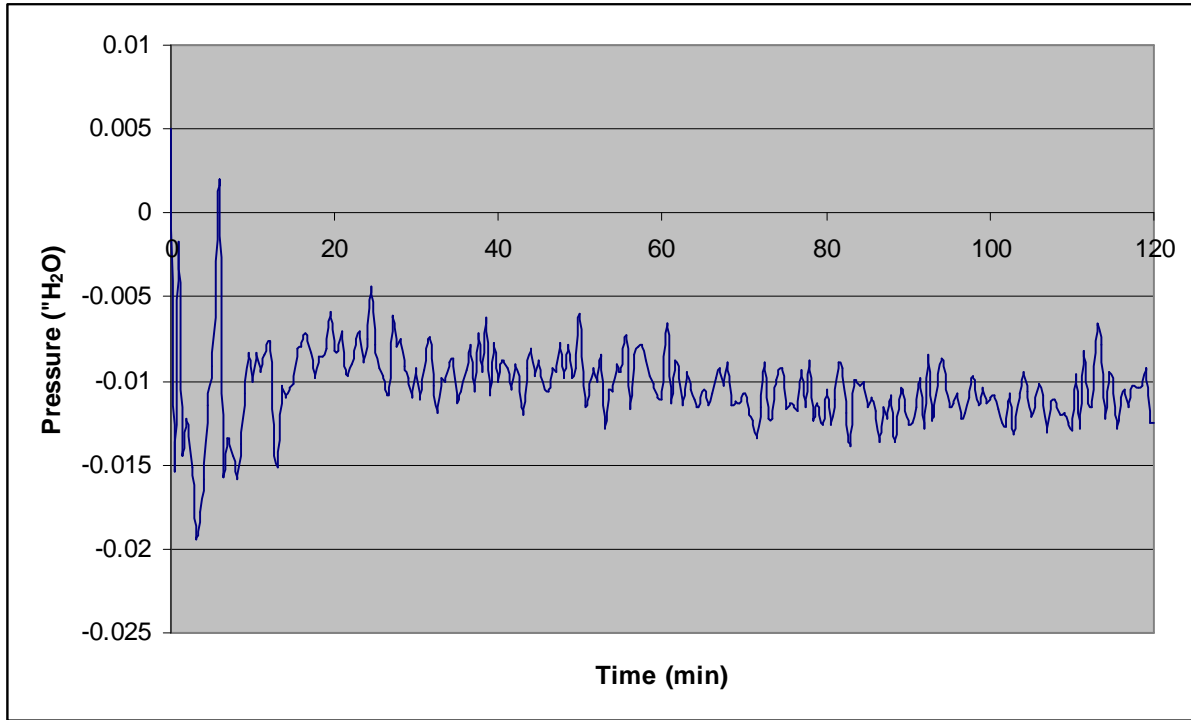

UNEXPOSED SURFACE TEMPERATURES (°F)

Time (Min)	TC1	TC2	TC3	TC4	TC5	TC6	TC7	TC8	TC9	TC10	TC11	TC12	TC13	TC14	TC15	TC16	TC17	TC18	TC19
0	68	68	68	67	67	67	67	68	68	68	69	69	68	69	69	68	69	69	68
1	69	69	69	67	68	68	68	69	68	70	71	70	69	69	70	69	71	70	69
2	72	73	73	69	69	69	70	71	71	74	76	74	72	72	73	73	77	74	72
3	74	77	75	71	71	71	71	73	72	78	80	78	75	76	76	78	81	79	74
4	73	76	74	71	72	72	71	73	71	76	78	77	74	76	76	76	78	77	73
5	73	75	73	70	72	71	70	72	71	75	77	76	73	75	74	75	76	75	72
6	73	75	73	70	71	71	70	72	71	75	76	76	73	75	74	75	76	75	72
7	74	78	76	71	73	73	71	74	73	78	82	80	75	77	78	76	83	80	74
8	75	79	77	71	74	73	72	75	73	80	84	81	77	80	79	76	84	81	75
9	76	80	77	73	75	74	73	75	73	81	84	82	78	80	79	76	84	81	75
10	77	80	77	73	75	74	73	75	73	81	85	82	78	81	79	76	84	81	76
11	78	82	79	74	76	75	74	77	74	84	88	84	80	82	81	76	87	83	77
12	80	84	80	75	78	76	75	78	76	85	90	86	81	84	83	77	89	85	78
13	80	84	81	76	78	77	75	78	76	86	91	87	82	85	83	77	89	85	78
14	80	84	80	76	78	77	75	78	76	85	90	86	82	85	83	77	88	85	78
15	80	84	81	76	78	77	75	78	76	85	90	86	81	85	83	77	89	85	78
16	81	85	82	76	79	78	76	79	76	87	91	87	82	86	84	78	90	86	79
17	82	86	82	77	80	78	76	79	76	88	93	88	83	87	85	78	91	87	79
18	82	87	83	78	80	79	77	80	77	89	94	89	84	88	85	79	92	88	79
19	82	87	83	78	81	79	77	80	77	89	94	89	85	88	86	79	92	88	79
20	83	87	83	78	81	79	77	80	77	89	94	89	85	88	86	79	92	88	80
21	83	87	84	78	81	80	77	80	77	89	94	90	85	89	86	80	93	89	80
22	84	88	84	79	82	80	78	81	78	90	95	91	85	90	87	80	94	89	81
23	85	89	85	79	83	81	78	81	78	91	97	92	86	91	88	81	95	91	81
24	85	90	85	80	83	81	79	82	78	92	98	92	87	91	88	81	96	91	82
25	86	91	86	80	83	81	79	82	79	93	99	93	87	92	89	82	97	92	82
26	86	92	86	81	84	82	79	83	79	94	100	94	88	93	90	82	99	93	83
27	87	92	87	81	85	82	80	84	80	94	100	95	89	94	91	83	100	93	83
28	87	93	87	82	85	83	80	84	80	95	101	95	89	94	91	83	100	94	83
29	88	93	88	82	86	83	80	84	80	95	101	96	90	95	92	83	100	94	83
30	88	94	88	82	86	83	81	85	80	96	102	96	90	96	92	84	101	95	84

UNEXPOSED SURFACE TEMPERATURES (°F) - *Continued*

Time (Min)	TC1	TC2	TC3	TC4	TC5	TC6	TC7	TC8	TC9	TC10	TC11	TC12	TC13	TC14	TC15	TC16	TC17	TC18	TC19
31	89	94	88	83	87	84	81	85	80	96	103	97	91	96	92	84	102	95	85
32	89	94	89	83	87	84	81	85	81	97	104	97	91	96	93	85	102	96	85
33	89	95	89	83	87	84	81	85	80	97	104	98	91	97	93	85	103	96	85
34	90	95	89	83	88	85	82	85	81	98	105	98	92	97	93	85	103	97	85
35	90	96	90	84	88	85	82	86	81	98	106	99	92	98	94	86	104	97	86
36	91	97	90	84	89	85	82	87	82	99	107	100	93	99	95	86	106	98	87
37	92	98	91	85	90	86	83	88	82	100	107	101	93	100	96	87	107	99	87
38	92	99	92	85	91	86	83	88	82	101	109	101	94	101	96	87	108	100	88
39	92	100	92	86	91	87	84	88	83	101	109	102	95	101	97	87	108	100	88
40	93	100	92	86	91	87	84	89	83	101	110	103	95	102	98	88	109	101	88
41	93	100	92	86	92	87	84	89	83	101	110	103	95	103	98	88	109	101	89
42	93	100	92	86	92	87	84	89	83	101	110	103	95	103	97	88	109	101	89
43	93	100	92	86	92	88	84	89	83	101	110	103	95	103	98	88	109	101	89
44	94	101	93	87	92	88	84	89	83	102	111	103	95	103	98	89	110	102	89
45	94	101	93	87	92	88	85	90	84	102	112	104	96	104	98	89	111	102	89
46	95	102	94	87	93	88	85	90	84	103	112	104	96	104	98	89	112	103	89
47	95	102	94	88	93	89	85	91	84	103	112	105	96	105	99	90	113	103	90
48	96	103	95	88	94	89	85	91	85	104	114	106	97	106	100	90	114	104	90
49	96	103	95	88	94	90	85	91	85	105	115	106	97	106	100	91	114	105	91
50	97	104	96	89	95	90	86	92	85	105	116	107	98	107	101	91	115	106	91
51	98	105	96	89	95	91	86	92	85	106	117	108	99	108	102	92	116	106	92
52	98	105	96	90	96	91	86	92	85	106	117	108	99	108	102	92	117	107	92
53	98	105	96	90	96	91	86	92	86	106	118	108	99	109	103	92	117	107	92
54	98	106	97	90	96	91	87	93	86	107	118	109	100	109	103	92	118	107	93
55	99	107	97	91	97	92	87	94	86	107	119	110	100	110	103	93	119	108	93
56	100	107	98	91	98	92	88	94	87	108	120	110	101	111	104	94	120	109	93
57	100	108	98	91	98	92	88	95	87	109	120	111	101	112	105	94	121	110	94
58	101	109	100	92	99	93	89	96	88	110	122	112	102	113	106	95	123	111	95
59	103	111	100	93	100	94	89	96	88	112	124	114	103	114	107	96	125	113	96
60	103	112	101	94	101	95	90	97	89	113	127	115	104	116	108	96	127	114	97

UNEXPOSED SURFACE TEMPERATURES (°F) - *Continued*

Time (Min)	TC1	TC2	TC3	TC4	TC5	TC6	TC7	TC8	TC9	TC10	TC11	TC12	TC13	TC14	TC15	TC16	TC17	TC18	TC19
61	104	112	101	94	101	95	90	97	89	114	127	116	105	117	109	96	128	114	97
62	105	113	102	94	102	96	91	98	89	114	127	116	105	117	109	97	128	115	97
63	105	113	102	95	102	96	91	98	90	115	128	116	106	118	110	97	129	116	97
64	106	114	103	95	103	96	91	99	90	116	128	117	107	119	110	98	130	116	98
65	107	114	103	96	103	97	92	100	91	116	130	118	107	120	111	98	131	117	98
66	107	116	104	96	104	98	92	100	91	118	131	119	108	121	112	99	133	118	100
67	108	117	105	97	105	98	93	101	91	119	133	120	109	122	112	100	134	119	100
68	108	118	105	98	106	98	93	101	92	119	134	121	110	123	113	101	135	120	101
69	108	118	105	98	107	99	94	102	92	120	134	121	110	124	114	101	136	120	101
70	109	118	105	98	107	99	94	102	92	120	135	121	110	124	114	102	136	121	101
71	109	118	106	99	108	100	94	102	92	121	136	122	111	125	115	102	137	121	101
72	110	119	106	99	108	100	94	103	92	121	136	122	112	125	115	103	138	122	102
73	110	119	106	99	108	100	94	103	92	121	136	123	112	126	115	103	138	122	102
74	110	119	107	100	109	100	94	103	92	122	136	123	112	127	116	103	139	122	102
75	110	120	107	100	109	100	94	103	92	122	137	124	112	127	116	103	139	123	102
76	110	120	107	100	109	100	95	104	93	122	137	124	112	127	116	104	139	123	102
77	110	120	107	100	109	100	94	104	93	121	137	124	112	128	117	104	140	124	102
78	110	120	107	100	109	101	94	103	93	121	138	125	112	127	118	104	139	124	102
79	110	121	108	100	109	101	95	103	93	121	139	125	112	127	118	104	140	124	102
80	110	121	108	100	110	101	95	104	93	121	139	125	112	128	118	104	141	124	102
81	111	121	108	100	110	101	95	104	93	122	139	126	112	129	118	104	142	125	103
82	111	122	109	101	110	102	96	105	94	122	139	125	112	129	118	105	142	125	103
83	111	121	108	101	110	101	96	104	93	122	139	125	112	129	118	105	142	125	103
84	111	121	109	101	111	102	96	105	94	122	139	125	113	130	118	105	143	126	104
85	111	122	109	101	111	102	96	105	94	122	139	126	112	131	119	105	144	127	104
86	112	122	109	101	111	102	96	105	94	123	139	127	113	131	120	106	144	126	104
87	112	122	109	101	112	102	96	105	95	123	139	127	113	131	119	106	144	127	104
88	112	122	109	101	112	103	96	105	95	123	139	127	113	131	119	106	144	127	104
89	111	122	110	101	112	103	96	105	95	123	139	127	113	132	119	107	145	127	104
90	111	122	110	101	112	103	96	106	95	123	140	126	113	132	119	107	145	125	104

UNEXPOSED SURFACE TEMPERATURES (°F) - *Continued*

Time (Min)	TC1	TC2	TC3	TC4	TC5	TC6	TC7	TC8	TC9	TC10	TC11	TC12	TC13	TC14	TC15	TC16	TC17	TC18	TC19
91	112	123	110	102	112	103	96	106	95	123	140	126	113	132	119	107	145	125	104
92	112	123	111	102	113	104	96	106	96	123	141	127	113	132	119	107	146	126	105
93	112	123	111	102	113	104	96	107	96	123	141	127	113	132	120	107	146	127	105
94	113	124	111	102	113	104	97	107	96	124	142	128	114	133	120	107	146	128	105
95	112	124	111	102	114	104	97	107	96	124	142	128	114	134	121	107	148	128	105
96	113	125	111	103	114	104	97	108	96	125	143	129	114	134	121	108	148	128	106
97	114	125	112	103	114	105	97	108	96	125	143	129	115	135	121	109	149	128	106
98	114	125	112	103	114	105	98	108	96	125	143	130	115	135	121	109	149	129	106
99	114	125	113	104	115	105	99	108	97	125	144	130	115	136	123	109	150	130	107
100	116	126	113	105	115	106	100	109	97	127	145	131	116	136	123	110	151	131	107
101	116	127	113	105	115	106	100	108	98	127	146	132	117	137	123	111	152	131	107
102	115	127	114	105	116	107	100	109	98	127	146	132	117	137	123	111	152	132	107
103	116	127	114	105	116	107	100	109	98	127	146	132	117	138	123	111	152	132	108
104	115	127	114	105	116	107	99	109	98	126	146	132	117	138	123	111	152	132	107
105	116	128	114	105	117	107	100	110	98	127	148	132	117	138	124	112	153	132	108
106	116	128	114	105	117	107	100	109	98	127	148	133	118	138	124	112	153	132	108
107	116	128	115	105	118	108	100	110	99	128	148	133	118	139	125	112	154	134	109
108	116	129	114	106	118	108	100	110	99	128	148	133	118	139	125	112	154	133	109
109	116	129	115	106	118	108	100	110	99	128	149	134	118	140	125	113	155	134	109
110	116	129	115	106	118	108	100	110	99	128	148	133	118	140	126	112	155	134	109
111	116	128	115	106	118	109	100	110	99	128	148	134	118	140	126	113	155	134	109
112	116	129	115	106	118	109	100	111	99	128	149	134	118	141	126	113	156	135	110
113	116	128	115	106	118	109	100	110	99	128	149	133	118	141	126	113	155	135	108
114	117	129	116	107	119	109	100	111	100	129	149	134	119	141	126	113	156	135	109
115	117	130	116	107	119	109	100	111	100	129	150	134	119	141	127	114	157	135	110
116	117	130	116	107	120	110	101	112	100	129	151	134	119	142	127	114	157	136	110
117	117	130	116	107	120	110	101	112	100	129	151	134	119	142	127	114	158	136	110
118	118	130	117	107	120	110	101	112	100	130	151	135	120	143	128	114	158	137	111
119	118	131	117	108	121	111	101	113	100	130	152	136	120	144	128	114	159	137	111
120	118	131	117	108	121	111	102	113	100	131	152	136	121	144	128	115	160	137	111

REVISION SUMMARY

DATE	PAGE	SUMMARY	INITIAL
November 26, 2013	--	Original Issue Date	

Appendix VI

Intertek Report Number 101460521COQ-003 (Feb. 2014)

TEST REPORT

Intertek

REPORT NUMBER: 101460521COQ-003
ORIGINAL ISSUE DATE: February 28, 2014

EVALUATION CENTER
Intertek Testing Services NA Ltd.
1500 Brigantine Drive
Coquitlam, B.C. V3K 7C1

RENDERED TO

PCL Constructors Canada Inc.
13911 Wireless Way, Suite 310
Richmond, B.C. V6V 3A4

PRODUCT EVALUATED: Horizontal Through-Penetration Firestop Systems
EVALUATION PROPERTY: Through Penetration Fire Resistance

Report of testing a six pipe configuration, 3-Ply CLT wall assembly using Hilti CP606 (Red) Firestop for compliance with the applicable requirements of the following criteria: CAN/ULC S115-11, *Standard Method of Fire Tests of Firestop Systems*.

This report is for the exclusive use of Intertek's Client and is provided pursuant to the agreement between Intertek and its Client. Intertek's responsibility and liability are limited to the terms and conditions of the agreement. Intertek assumes no liability to any party, other than to the Client in accordance with the agreement, for any loss, expense or damage occasioned by the use of this report. Only the Client is authorized to permit copying or distribution of this report and then only in its entirety. Any use of the Intertek name or one of its marks for the sale or advertisement of the tested material, product or service must first be approved in writing by Intertek. The observations and test results in this report are relevant only to the sample tested. This report by itself does not imply that the material, product, or service is or has ever been under an Intertek certification program.

1 Table of Contents

	Page
1 Table of Contents.....	2
2 Introduction	3
3 Test Samples	3
3.1. SAMPLE SELECTION	3
3.2. SAMPLE AND ASSEMBLY DESCRIPTION	3
4 Testing and Evaluation Methods	4
4.1. UNEXPOSED THERMOCOUPLE LOCATIONS	4
4.2. THE FIRE TEST	5
4.3. THE HOSE STREAM TEST.....	5
5 Testing and Evaluation Results.....	6
5.1. FIRE TEST OBSERVATIONS.....	6
5.2. EXAMINATION OF RESULTS	6
6 Conclusion	7
APPENDIX A – Photographs	3 Pages
APPENDIX B – Temperature and Pressure Data.....	6 Pages
REVISION SUMMARY	

2 Introduction

Intertek Testing Services NA Ltd. (Intertek) has conducted testing for PCL Constructors Canada Inc. on a firestop system for a 3-Ply CLT wall assembly for a six pipe configuration using Hilti CP606 (Red) firestop caulking. The assembly was tested to CAN/ULC S115-11, *Standard Method of Fire Tests of Firestop Systems*.

This evaluation began February 4, 2014 and was on the same day. Testing was witnessed by Mr. Marc Narduzzi representing PCL Constructors Canada Inc.

3 Test Samples

3.1. SAMPLE SELECTION

Intertek did not select the specimen and did not verify the composition, manufacturing techniques or quality assurance procedures. The samples were received at the Evaluation Centre on December 17, 2013.

3.2. SAMPLE AND ASSEMBLY DESCRIPTION

Installation of the pipe penetrations and application of the firestop was conducted by PCL Constructors Canada Inc. on January 2, 2014 and allowed to cure for four weeks prior to testing.

The test assembly consisted of a 3 ply Cross Laminated Timber (CLT) wall, measuring 5 ft. wide by 4 ft. 6 in. high, with six holes cut out, two each measuring approximately 5 in., 7in. and 8 in. diameters. These contained the six pipe penetrations which are listed below. A 1 in. to 1-1/2 in. thickness and a depth of up to 1 in. of "Hilti CP606 (Red)" firestop caulking was installed on both exposed and unexposed sides with Roxul mineral wool insulation was used inbetween. The ends of the pipe was stuffed using a ceramic fiber blanket rolled up on the exposed side. A photo of the setup can be found in Appendix A.

Penetration No.	Pipe Description
1	6 in. Cast Iron
2	6 in. Steel
3	4 in. EMT
4	4 in. Cast Iron
5	2 in. Steel
6	2 in. EMT

4 Testing and Evaluation Methods

4.1. UNEXPOSED THERMOCOUPLE LOCATIONS

Unexposed surface thermocouples, as required by the Standard, were mounted on the unexposed surface to determine eligibility for T ratings. Thermocouple locations are indicated in the following table:

TC #	Location	TC #	Location
1	On CLT surface, 25 mm away from 6 in. Cast Iron pipe	13	On CLT surface, 25 mm away from 6 in. Steel pipe
2	On firestop surface for 6 in. Cast Iron pipe	14	On firestop surface for 6 in. Steel pipe
3	On CLT surface, 100 mm away from opening of 6 in. Cast Iron pipe	15	On CLT surface, 100 mm away from opening of 6 in. Steel pipe
4	On 6 in. Cast Iron pipe, 25 mm away from firestop surface	16	On 6 in. Steel pipe, 25 mm away from firestop surface
5	On CLT surface, 25 mm away from 4 in. EMT pipe	17	On CLT surface, 25 mm away from 4 in. Cast Iron pipe
6	On firestop surface for 4 in. EMT pipe	18	On firestop surface for 4 in. Cast Iron pipe
7	On CLT surface, 100 mm away from opening of 4 in. EMT pipe	19	On CLT surface, 100 mm away from opening of 4 in. Cast Iron pipe
8	On 4 in. EMT pipe, 25 mm away from firestop surface	20	On 4 in. Cast Iron pipe, 25 mm away from firestop surface
9	On CLT surface, 25 mm away from 2 in. Steel pipe	21	On 2 in. EMT pipe, 25 mm away from firestop surface
10	On firestop surface for 2 in. Steel pipe	22	On CLT surface, 25 mm away from 2 in. EMT pipe
11	On CLT surface, 100 mm away from opening of 2 in. Steel pipe	23	On firestop surface for 2 in. EMT pipe
12	On 2 in. Steel pipe, 25 mm away from firestop surface	24	On CLT surface, 100 mm away from opening of 2 in. EMT pipe

4.2. THE FIRE TEST

The test assembly was mounted on our pilot scale fire test furnace. The furnace opening for horizontal fire separations has dimensions of 70 in. in width by 44 in. in length. The furnace opening for vertical fire separations has dimensions of 70 in. in width by 56 in. in height.

Furnace temperatures are measured by six uniformly distributed thermocouples. These readings were recorded by a Yokogawa data acquisition system (ID no. WH D3593/WH D3595) recorded every 30 seconds and displayed every 15 seconds. See Appendix C – Temperature Data. The wall assembly was subjected to the standard time/temperature curve of CAN/ULC S101-07 and the unexposed surface was observed.

Furnace pressures are measured by one probe, located 12 in. below the exposed surface of the horizontal fire separation. The exhaust opening is located along the back of the furnace. Four natural gas burners are located in the furnace floor, as are four secondary air inlets. A positive pressure of 0.010 in. water column (2.5 Pa.) was maintained in the furnace. The pressure was continuously monitored throughout the test duration.

The burners were ignited and controlled to maintain furnace temperature rise to conform as closely as possible to the standard time/temperature curve. Observations, furnace temperatures, the pressure differential, and unexposed temperatures were recorded throughout the test duration.

4.3. THE HOSE STREAM TEST

After the fire exposure, the test assembly was positioned for a standard hose stream test on the fire-exposed face. The hose stream was delivered through a 2-1/2 in. hose discharging through a National Standard Playpipe of corresponding size, equipped with a 1-1/8 in. discharge tip of the standard taper smooth bore pattern without shoulder at the orifice.

The hose stream was applied at 30 psi, for a period of 48 seconds per square foot of exposed area. The hose stream was directed first at the middle of the assembly and then at all parts of the exposed surface, changing direction slowly.

5 Testing and Evaluation Results

5.1. FIRE TEST OBSERVATIONS

TIME (min.)	EXPOSED SIDE	UNEXPOSED SIDE
3:00	Test started	
9:00	No change	Smoke coming through pipes 1, 4, and 5 from surface coat and heating up
15:00	No change	No change
24:00	No change	Smoke/moisture at top of pipes 4 and 5
		Firestop intumescent is reacting on the outside of pipes 1, 2, 4, and 5
30:00	No change	No change
40:00	No change	No change
50:00	First layer of timber has burned off and fallen to the furnace floor	No change
57:00	Second layer of timber is reacting	No change
73:15		No change
91:00	Test Discontinued	

5.2. EXAMINATION OF RESULTS

Single point temperature rise allowable:

$$^{\circ}\text{F Allowable} = 358^{\circ}\text{F} + ^{\circ}\text{F Starting Temperature}$$

At approximately 16 min 30 seconds into the test, the 4 in. EMT pipe was over the allowable temperature rise requirements and by 50 min 30 seconds, all six pipes were over the allowable.

On the firestop itself, the 6 in. Steel area was first to be over the allowable at approximately 45 minutes into the test and by 70 minutes, all six pipes were over the allowable.

After 91 minutes, there was no flame through or openings through the firestop around all 6 pipes. The system had met the requirements for the 'F' rating.

6 Conclusion

The PCL Constructors Canada Inc. wall assembly, as described in this report, met the following 'F' and 'T' performance ratings in accordance with CAN/ULC S115-11, *Standard Method of Fire Tests of Firestop Systems*.

Assembly Description	'F' Rating	'T' Rating	Hose Stream
A 1 in. to 1-1/2 in. thickness and a depth of up to 1 in. of "Hilti CP606 (Red)" firestop caulking was installed on both exposed and unexposed sides with Roxul mineral wool insulation was used in between	1-1/2 Hr.	--	N/A

The conclusions of this test report may not be used as part of the requirements for Intertek product certification. Authority to Mark must be issued for a product to become certified.

INTERTEK TESTING SERVICES NA LTD.

Tested and
Reported by:



Dave Park
Technician – Building Products

Reviewed by:



Greg Philp
Reviewer – Fire Testing

APPENDIX A

Photographs



Unexposed Side Prior to the Fire Test

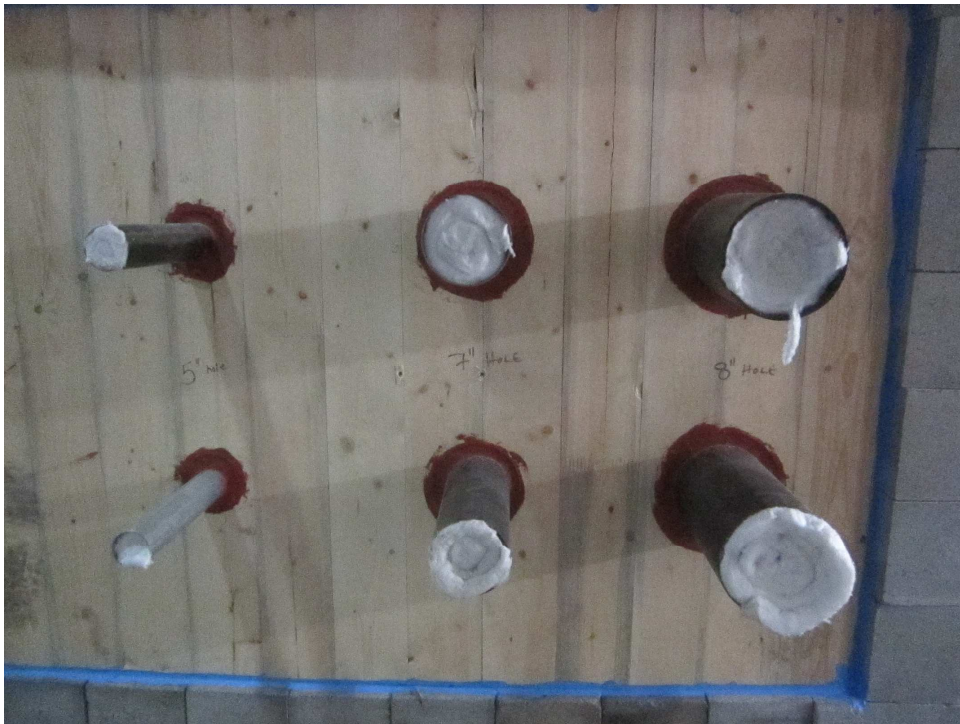

Exposed Side Prior to the Fire Test



Unexposed Side During the Fire Test



Exposed Side After Fire Test



Exposed Side After the Hose Stream Test

APPENDIX B

Temperature Data

TIME TEMPERATURE CURVE
AVERAGE TEMPERATURE OF FURNACE DURING THE FIRE TEST

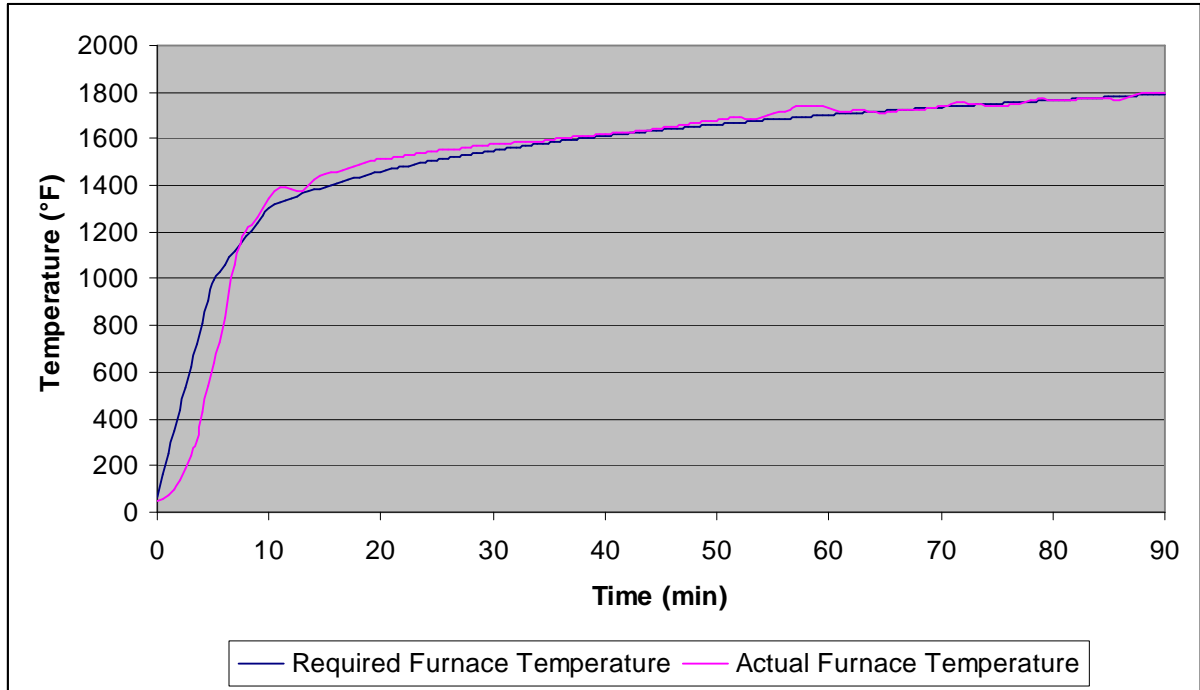

TIME PRESSURE CURVE
PRESSURE INSIDE THE FURNACE 12 IN. BELOW THE CEILING DURING THE FIRE TEST

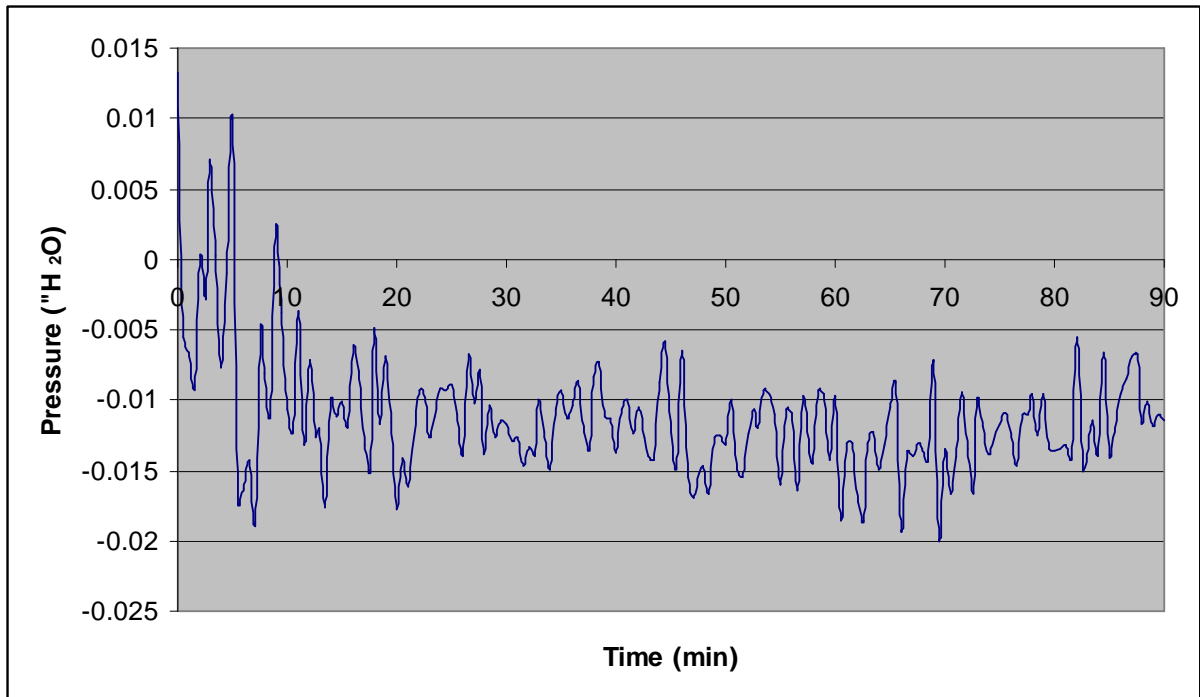

UNEXPOSED SURFACE TEMPERATURES (°F) GRAPH

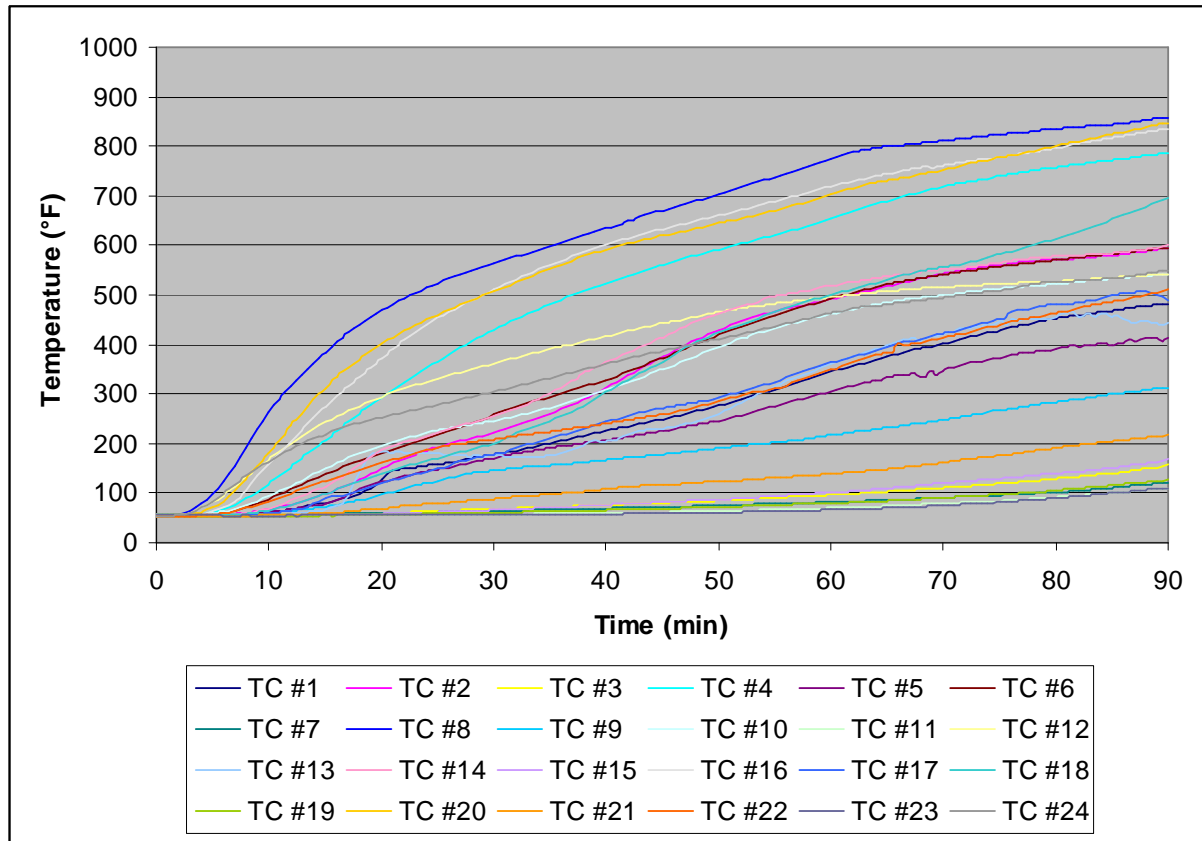

****Refer to Section 4.1 of this report for TC Locations***

UNEXPOSED SURFACE TEMPERATURES (°F)

Time (min)	TC #1	TC #2	TC #3	TC #4	TC #5	TC #6	TC #7	TC #8	TC #9	TC #10	TC #11	TC #12	TC #13	TC #14	TC #15	TC #16	TC #17	TC #18	TC #19	TC #20	TC #21	TC #22	TC #23	TC #24
0	56	55	56	55	56	55	55	54	56	55	57	55	55	54	55	53	54	54	55	54	55	54	55	52
1	56	55	56	55	55	55	55	54	55	55	57	55	54	54	55	53	54	54	55	53	54	54	55	53
2	55	55	55	55	55	54	55	58	55	55	57	55	54	53	54	54	54	54	55	55	54	54	55	55
3	55	55	55	56	55	55	55	65	55	55	56	60	54	53	54	55	53	54	54	57	54	54	55	60
4	55	55	55	58	55	55	55	78	55	56	56	70	53	53	54	58	53	54	54	62	54	55	55	71
5	56	56	55	62	55	57	55	98	55	59	56	82	54	54	54	63	54	54	55	70	54	57	55	84
6	56	56	55	68	56	60	54	124	55	63	56	96	54	55	54	70	54	55	54	83	53	60	55	99
7	56	58	55	77	56	65	55	156	56	69	55	113	54	56	53	82	54	56	54	104	54	64	55	117
8	57	60	55	89	57	71	55	192	56	76	55	131	54	59	53	105	55	58	54	130	54	70	55	134
9	58	62	55	102	58	79	55	228	57	85	55	149	54	64	53	134	56	61	54	155	55	76	55	149
10	61	66	55	118	60	88	56	263	59	94	55	167	55	69	53	158	58	65	54	179	55	84	55	163
11	64	71	56	135	64	98	56	291	62	103	55	185	56	77	54	181	61	70	54	205	56	92	55	177
12	68	77	56	152	67	108	56	316	65	114	55	201	58	85	54	204	65	76	54	236	56	100	55	189
13	71	83	56	170	70	118	57	339	67	126	55	216	60	94	54	227	69	83	54	260	57	108	55	200
14	75	91	57	188	73	127	57	362	69	137	55	230	63	104	55	252	77	91	55	289	58	116	55	210
15	80	99	57	207	78	138	57	385	73	149	55	243	67	114	55	274	90	99	55	314	59	124	55	220
16	86	108	58	225	85	148	58	406	77	160	55	255	74	126	55	295	94	108	55	336	60	131	55	229
17	92	117	58	244	95	158	58	424	81	171	56	266	93	142	56	316	99	116	55	353	62	139	55	236
18	98	127	59	261	108	167	59	441	86	181	56	276	144	158	56	334	105	125	55	370	65	146	55	242
19	110	139	59	277	116	175	59	456	91	190	56	286	176	173	57	353	113	133	56	386	66	153	55	248
20	126	150	60	293	123	182	60	469	96	197	56	295	184	187	58	372	120	140	56	401	68	161	55	253
21	146	160	61	308	129	188	60	481	103	203	56	303	182	197	59	390	127	146	57	415	71	168	55	258
22	151	170	62	323	134	196	61	493	109	210	57	311	182	203	59	408	132	153	57	427	74	174	55	263
23	151	178	62	338	139	204	61	504	115	216	57	318	180	209	60	425	137	159	58	439	76	181	55	268
24	155	186	63	352	143	211	62	514	119	221	57	325	180	216	61	440	144	166	58	450	77	187	56	273
25	158	193	64	366	148	219	62	524	124	226	57	331	179	223	62	454	150	171	59	460	80	192	56	278
26	161	200	65	380	152	227	62	532	130	230	57	337	177	229	62	466	156	179	59	470	80	196	56	283
27	166	205	65	393	157	234	63	541	136	234	57	344	176	235	63	478	164	182	59	480	82	199	56	289
28	170	210	66	406	162	241	63	549	140	238	58	350	175	242	64	489	170	188	60	489	85	202	56	294
29	174	216	67	418	167	250	63	556	143	242	58	356	175	250	65	500	173	194	60	498	87	205	56	299
30	177	223	68	430	171	258	64	564	146	246	58	362	176	257	66	511	178	200	61	507	88	208	56	304

UNEXPOSED SURFACE TEMPERATURES (°F) – *Continued*

Time (min)	TC #1	TC #2	TC #3	TC #4	TC #5	TC #6	TC #7	TC #8	TC #9	TC #10	TC #11	TC #12	TC #13	TC #14	TC #15	TC #16	TC #17	TC #18	TC #19	TC #20	TC #21	TC #22	TC #23	TC #24
31	181	229	68	441	175	266	64	570	148	251	58	368	173	263	67	521	182	209	61	516	91	211	56	310
32	185	237	69	451	179	274	65	577	151	256	58	374	171	271	68	532	191	220	62	525	92	215	56	315
33	190	244	70	461	182	281	65	584	153	261	58	379	172	280	69	541	198	229	62	534	94	218	56	321
34	195	252	71	471	186	288	66	591	155	267	58	385	173	290	70	551	204	238	62	544	96	221	57	327
35	200	260	72	481	190	294	66	598	156	272	58	390	175	301	71	560	211	246	63	553	98	224	57	333
36	205	269	73	490	194	301	67	605	158	279	58	396	179	313	72	569	217	255	64	561	100	227	57	338
37	211	279	73	499	197	308	67	613	159	285	59	400	189	325	73	577	222	265	64	569	101	229	57	343
38	216	288	74	507	200	314	68	620	161	292	59	406	197	344	73	585	228	275	65	577	102	233	57	349
39	221	299	75	515	203	321	68	627	164	299	59	411	205	352	75	593	236	289	65	585	105	236	57	355
40	225	312	76	523	207	328	69	634	166	307	60	416	204	363	76	601	243	303	65	591	109	239	58	361
41	230	324	76	531	210	336	70	641	169	314	60	421	208	373	77	608	250	316	66	598	111	243	58	366
42	235	337	77	538	214	345	70	649	171	323	61	427	218	383	78	615	256	329	67	604	113	247	58	372
43	239	350	78	546	218	354	71	656	174	332	61	432	225	393	80	621	262	341	68	609	114	250	59	377
44	244	363	79	553	222	364	71	664	176	340	62	437	227	404	81	627	268	353	68	615	116	254	59	382
45	249	375	80	560	225	373	72	670	178	350	62	442	230	415	82	633	272	366	69	620	117	259	59	387
46	254	388	81	567	229	383	72	677	181	359	62	447	234	426	83	639	276	381	69	625	118	264	59	392
47	260	399	82	574	234	393	73	683	183	368	62	452	240	437	84	645	279	393	70	630	119	268	60	397
48	265	410	83	580	238	402	74	690	186	377	63	456	244	447	85	650	283	405	71	635	121	274	60	402
49	271	420	84	586	242	411	74	697	188	386	63	461	252	455	86	655	287	415	71	640	123	280	60	407
50	277	429	85	592	246	420	75	704	190	395	64	465	261	463	87	661	293	425	72	645	123	285	61	411
51	283	439	86	598	252	428	76	711	193	404	64	469	272	470	88	666	299	432	73	649	124	291	62	416
52	290	448	87	604	257	437	76	718	195	412	65	473	283	477	90	672	305	442	73	654	126	297	62	421
53	297	455	88	609	263	445	77	725	198	420	65	476	295	483	91	677	311	448	74	659	127	303	62	426
54	303	461	89	615	270	452	78	732	200	426	66	479	305	492	92	683	318	457	75	665	129	306	63	431
55	310	467	91	621	276	459	79	738	202	433	67	482	314	497	94	689	325	465	76	670	131	312	63	437
56	317	472	92	627	282	466	79	745	205	439	67	485	326	501	96	695	333	472	77	676	133	317	64	442
57	324	477	93	633	288	473	80	752	207	445	68	488	335	505	97	701	341	481	77	683	134	325	65	447
58	332	481	94	640	293	479	80	760	210	451	69	490	343	509	98	707	349	487	78	689	135	333	65	453
59	339	487	95	646	300	486	81	768	213	456	69	492	352	514	100	713	357	494	79	696	137	341	66	459
60	346	492	96	654	303	492	82	775	216	461	70	495	362	519	101	719	363	500	80	703	139	348	66	463

UNEXPOSED SURFACE TEMPERATURES (°F) – *Continued*

Time (min)	TC #1	TC #2	TC #3	TC #4	TC #5	TC #6	TC #7	TC #8	TC #9	TC #10	TC #11	TC #12	TC #13	TC #14	TC #15	TC #16	TC #17	TC #18	TC #19	TC #20	TC #21	TC #22	TC #23	TC #24
61	351	497	98	661	311	499	83	782	219	467	70	497	368	523	103	725	370	506	80	710	141	356	67	468
62	357	501	99	668	316	505	83	788	222	471	71	500	376	526	104	729	375	512	81	715	142	363	67	472
63	363	506	100	676	322	510	84	792	225	476	71	502	383	530	106	734	382	518	82	721	144	371	68	476
64	369	511	101	683	328	516	85	797	228	480	73	505	391	533	108	739	387	524	83	726	146	379	69	477
65	376	517	103	690	333	521	86	800	231	484	73	508	397	536	110	743	395	530	85	730	148	382	70	480
66	381	522	104	696	337	525	87	802	235	488	74	509	407	540	112	749	401	538	86	735	151	401	71	484
67	388	527	106	702	340	530	88	803	238	491	76	511	410	542	113	753	405	542	87	739	153	398	72	487
68	393	532	107	707	336	534	89	806	241	494	77	513	406	546	115	756	410	548	88	743	155	402	73	489
69	396	537	109	713	346	537	90	809	244	497	78	514	418	549	118	756	418	551	89	747	158	409	74	492
70	402	542	111	718	346	541	91	811	247	499	79	515	423	551	120	760	421	555	91	752	161	413	75	494
71	407	546	112	722	354	544	92	814	252	502	80	516	426	552	122	764	426	559	92	757	164	418	76	497
72	413	550	114	726	360	547	92	816	255	504	81	518	433	554	124	767	432	564	93	763	168	423	77	501
73	418	553	115	730	366	551	93	818	259	507	82	519	438	557	126	771	439	569	94	768	170	429	79	503
74	424	557	117	734	370	554	94	821	263	510	83	521	441	560	127	774	444	575	96	773	173	435	80	506
75	429	560	119	739	373	557	96	823	267	512	85	522	447	564	129	777	451	581	97	777	175	441	81	509
76	435	563	121	743	378	560	96	826	270	515	86	524	450	567	131	782	467	588	98	781	178	446	83	513
77	440	566	123	746	382	562	98	828	273	517	87	525	452	572	133	785	470	594	100	785	182	450	85	517
78	444	568	125	750	384	565	99	830	277	519	89	526	451	574	135	789	474	601	101	790	185	455	87	521
79	448	570	127	754	389	568	100	833	280	521	90	526	449	576	137	793	478	607	103	795	188	459	88	524
80	452	572	129	757	391	570	102	835	283	522	92	528	454	577	139	797	480	614	106	801	191	463	90	527
81	455	573	131	761	395	573	103	837	286	524	93	529	461	579	142	801	480	621	108	805	194	468	92	527
82	459	574	133	763	393	576	105	839	290	526	95	530	454	580	144	805	485	629	109	810	197	475	94	528
83	461	575	135	767	399	578	106	841	293	528	97	532	462	581	146	809	487	636	111	815	199	479	96	530
84	465	577	137	769	401	580	108	843	296	530	99	533	463	582	148	813	493	644	114	820	201	483	98	532
85	468	579	139	772	400	583	110	844	299	532	100	534	454	584	151	817	498	652	116	825	204	486	100	534
86	471	582	142	775	404	586	112	846	302	534	102	536	451	586	154	821	503	661	118	829	206	490	102	536
87	475	585	145	778	407	588	115	849	305	536	104	537	444	589	156	824	505	670	120	833	209	496	104	539
88	478	588	149	780	412	591	117	852	308	538	106	539	449	592	159	828	506	679	122	838	212	500	106	542
89	480	591	152	783	413	593	119	855	310	540	109	541	442	596	163	833	502	688	124	843	214	506	109	546
90	483	595	156	786	414	596	121	859	313	541	111	542	445	600	167	836	490	696	126	848	217	510	111	550

REVISION SUMMARY

DATE	PAGE	SUMMARY	INITIAL
February 28, 2014	--	Original Issue Date	--



Head Office

Pointe-Claire

570 Saint-Jean Blvd
Pointe-Claire, QC
Canada H9R 3J9
T 514 630-4100

Vancouver

2665 East Mall
Vancouver, BC
Canada V6T 1Z4
T 604 224-3221

Québec

319 Franquet
Québec, QC
Canada G1P 4R4
T 418 659-2647



OUR NAME IS INNOVATION

Appendix D

Engineering Modifications to Fire Tested and Listed
Assemblies – *Innovation* January/February 2007
APEGBC



Professional Engineers
and Geoscientists of BC

Building progress through innovation every day

200 - 4010 Regent Street, Burnaby, BC V5C 6N2
T. 604-430-8035 | F. 604-430-8085 | 1-888-430-8035
www.apeg.bc.ca

Engineering Modifications to Fire Tested and Listed Assemblies - *Innovation* January/February 2007

For both new and existing construction, the BC Building Code mandates that some structural elements such as exterior walls, load bearing walls, columns, beams, floor/ceiling assemblies and roofs achieve a minimum fire resistance rating. Similarly, fire-rated separations or assemblies are also required between different uses and occupancies. When a fire-rated assembly is penetrated by closures, doors, piping, wires, conduits, ducting or other elements, it requires adequate protection systems to maintain the level of fire separation of the assembly. Typically, building designers either specify a design listed by a testing/certification agency or use generic designs or assemblies outlined in the Building Code.

Fire-rated assemblies are tested in accordance with a standard fire test and assigned an hourly fire resistance rating based on time to failure. In Canada, this standard is CAN/ULC-S101-04, Standard Methods of Fire Endurance Tests of Building Construction and Materials. Similar standards, such as ASTM E119 and UL 263, are used in the US to establish a fire resistance rating for various building materials.

In Canada, these tests must be carried out by independent testing/certification agencies accredited by the Standards Council of Canada. These agencies play an important role in the certification and quality control of tested products. These certifications are then listed in their directories and these listings may be used by architects, engineers, designers, authorities or contractors in designing and assessing the fire resistance rating of various assemblies and systems.

- Over the years, questions have been raised regarding modifications to listed assemblies – that is, when a manufacturer, supplier, designer, contractor or installer makes changes to the assembly that were not included and/or contemplated as part of the original testing/listing of that product. The ULC list of equipment and materials includes some supplementary information to assist the users in deviations from the listed assemblies; these acceptable deviations are listed under heading “Consideration of Variations from Tested Designs” and provide guidance with respect to limits to these variations and/or transfer of components from one design to another before these changes impact the performance of the assembly. Any modification to a listed assembly or system beyond that envisioned under the applicable standard should be assessed to ensure the level of performance expected by the listing.

From a practical point of view, listed assemblies are often modified either during the design or construction stages of building projects. As the manufacturers of various assemblies/systems have a vested interest in the use of their products and generally have an in-depth knowledge of them, they are often asked to evaluate and provide suggestions for modifying their listed systems to suit specific construction conditions. However, it is not feasible for manufacturers to test every variation of a product. In order to assist engineers and architects in such matters, the performance of modifications to listed assemblies may be formally commented upon by manufacturers based on the test results from similar tested assemblies/systems and often without the consent of the listing agency that originally certified the product.

For instance, in the case of the firestop industry, some firestop manufacturers have been issuing commentaries on modifications to listed assemblies in the form of “Engineering Judgements.” “Engineering Judgements” are often presented in such a manner that they can cause confusion as the document may refer to an expectation that the modified assembly will pass a ratings test. Many engineers, architects, designers, authorities, and contractors have traditionally accepted these “Engineering Judgements,” assuming that they either have current listing, or that they have been reviewed and someone is taking responsibility for this modification.

The fact is that these manufacturer supplied “Engineering Judgements” need to include an engineer’s seal. Otherwise engineers and/or architects may unknowingly take responsibility for these modifications under their Letters of Assurance. This concern was brought to the attention of the APEGBC Building Codes Committee and in July 2006 the Committee issued a letter to several firestop manufacturers indicating that all “Engineering Judgments” should carry confirmation of engineering review.

Technical documents dealing with modifications to listed assemblies or the development of new assemblies not specifically listed relating to fire protection applications in buildings involves the practice of professional engineering as defined in the *Engineers and Geoscientists Act of British Columbia*. On this basis, these documents must be sealed by a professional engineer registered or licensed in BC who shall take responsibility for the design under seal.

In summary, if any modification is made to a listed assembly to address conditions outside a listing, or to address changes in materials or methods of installation to a listed assembly, these designs require confirmation of engineering review and all deviations to a listed assembly must be clearly identified as such. Confirmation of engineering review is provided by the engineer placing his professional seal on the document. This professional engineer must be registered or licensed in BC. The noted exception being where confirmation of the acceptability of the modifications is provided by the appropriate listing agency accredited by the Standards Council of Canada.

Appendix E

Fire Performance of Cross-Laminated Timber
Panel-to-Panel Joints, March 31, 2015, FPInnovations

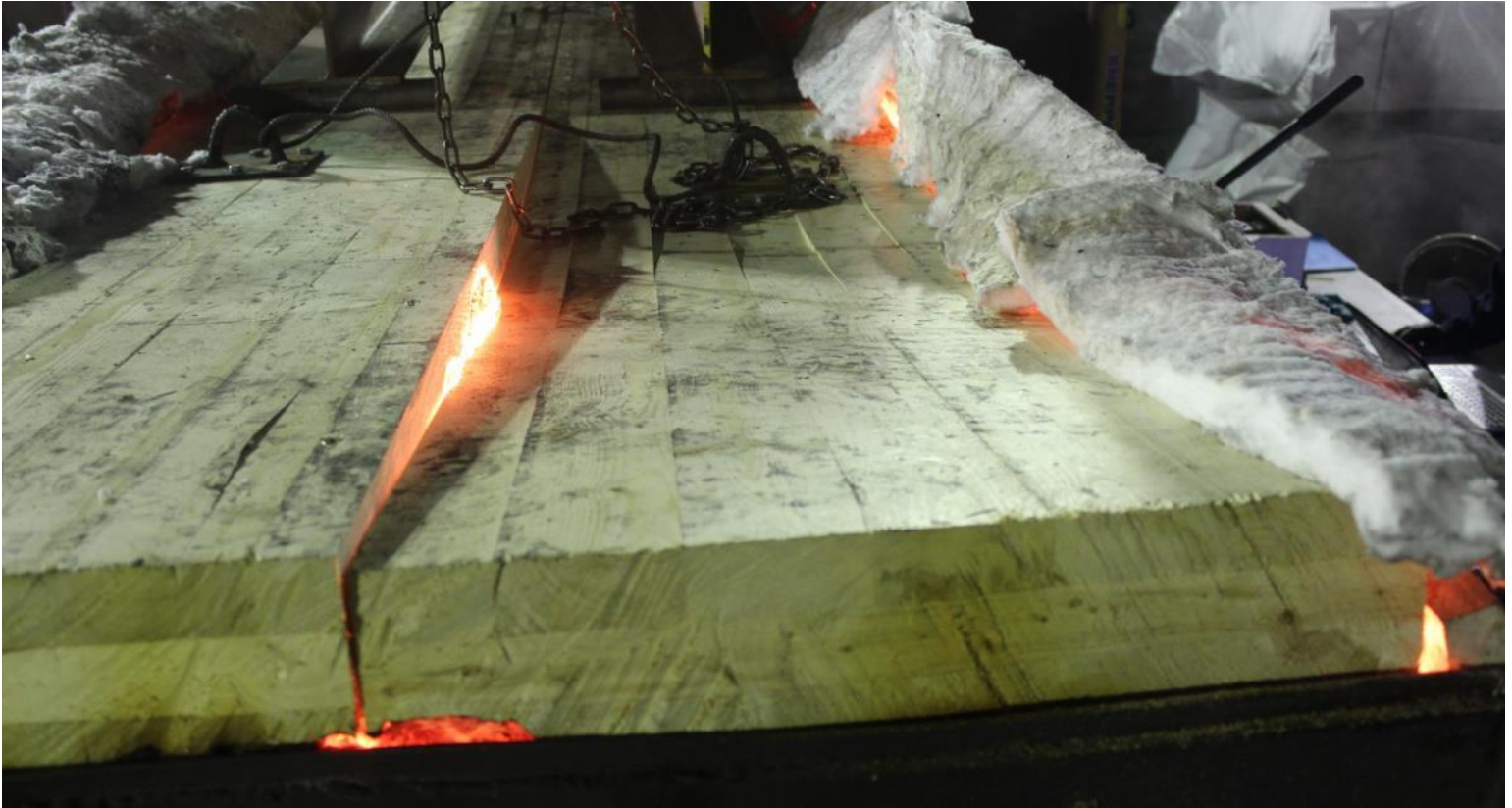

Fire Performance of Cross-Laminated Timber Panel-to-Panel Joints

Date: March 31, 2015

By: Christian Dagenais, Eng., M.Sc.,
Advanced Building Systems Department

Report prepared for:

**Forestry Innovation Investment Ltd.
Suite 1200 – 1130 West Pender St.
Vancouver, BC, V6E 4A4**

FPIinnovations is a not-for-profit world leader that specializes in the creation of scientific solutions in support of the Canadian forest sector's global competitiveness and responds to the priority needs of its industry members and government partners. It is ideally positioned to perform research, innovate, and deliver state-of-the-art solutions for every area of the sector's value chain, from forest operations to consumer and industrial products. FPIinnovations' staff numbers more than 525. Its R&D laboratories are located in Québec City, Ottawa, Montréal, Thunder Bay, Edmonton and Vancouver, and it has technology transfer offices across Canada. For more information about FPIinnovations, visit: www.fpinnovations.ca.

Follow us on:  

PROJECT N^o 301009649:

Fire Performance of Cross-Laminated Timber Panel-to-Panel Joints

ACKNOWLEDGEMENTS

This project was financially supported by the Forest Innovation Investment of British Columbia under the FII recipient agreement (FII – 14/15 – 068).

The author would like to thank Prof. Pierre Quenneville from the University of Auckland (NZ) and Dr. Mohammad Mohammad from FPIinnovations for their guidance on detailing connections as well as for providing valuable comments throughout this project.

Special thanks to Prof. George Hadjisophocleous, Ba Lamthien, Matt Turco, Aaron Akotuah Ohene and Jordan Giberson from Carleton University for their professionalism and continued support during the testing phase of this project.

REVIEWERS

Lindsay Osborne, M.A.Sc., Scientist
Sylvain Gagnon, Eng., Research Leader
Serviceability & Fire Performance Group
Advanced Building Systems

PROJECT LEADER

Christian Dagenais, Eng., M.Sc.
Serviceability & Fire Performance
Advanced Building Systems
Phone: 418-659-2647
christian.dagenais@fpinnovations.ca

© 2015 FPIinnovations. All rights reserved. Unauthorized copying or redistribution prohibited.

Disclosure for Commercial Application: If your mill requires assistance to implement these findings, please contact FPIinnovations.

TABLE OF CONTENTS

List of Tables	iv
List of Figures	iv
1 OBJECTIVE.....	1
2 BACKGROUND.....	1
3 TECHNICAL TEAM	2
4 MATERIALS AND METHODS	3
4.1 Fire Testing	3
4.2 Spline Preliminary Evaluation	5
5 RESULTS.....	7
5.1 Half-lapped Joint – 3-ply CLT	7
5.2 Half-lapped Joint – 5-ply CLT	10
5.3 Half-lapped Joint – 7-ply CLT	13
5.4 Internal Spline – 3-ply CLT	17
5.5 Internal Spline – 5-ply CLT	18
5.6 Single Surface Spline – 3 ply CLT	21
5.7 Single Surface Spline – 5 ply CLT	24
5.8 Double Surface Spline – 3 ply CLT	27
5.9 Double Surface Spline – 5 ply CLT	30
5.10 Double Surface Spline – 7 ply CLT	34
6 DISCUSSION	37
6.1 Half-lapped Joint.....	37
6.2 Internal Spline.....	37
6.3 Single Surface Spline	38
6.4 Double Surface Spline	38
7 CONCLUSION AND RECOMMENDATIONS.....	39
8 REFERENCES	41

LIST OF TABLES

Table 1 – Test matrix	3
-----------------------------	---

LIST OF FIGURES

Figure 1. Intermediate-scale furnace at Carleton University.....	3
Figure 2. CLT panel-to-panel joint details	4
Figure 3. Intumescent sealant used in the panel-to-panel joints	5
Figure 4. CLT bending test under ambient conditions.....	6
Figure 5. Head pull-through in CLT bending test under ambient conditions	7
Figure 6. 3-ply half-lapped joint load and deflection measurements.....	8
Figure 7. Failure of the 3-ply half-lapped joint.....	8
Figure 8. Furnace temperature for the 3-ply half-lapped joint (average values)	9
Figure 9. Temperature profiles for the 3-ply half-lapped joint.....	9
Figure 10. Temperature profiles at the half-lapped joint of the 3-ply CLT.....	10
Figure 11. 5-ply half-lapped joint load and deflection measurements.....	11
Figure 12. Failure of the 5-ply half-lapped joint.....	11
Figure 13. Furnace temperature curve for the 5-ply half-lapped joint (average values).....	12
Figure 14. Temperature profiles for the 5-ply half-lapped joint (average values).....	12
Figure 15. Temperature profiles at the half-lapped joint of the 5-ply CLT.....	13
Figure 16. 7-ply half-lapped joint load and deflection measurements.....	14
Figure 17. Failure of the 7-ply half-lapped joint.....	14
Figure 18. Differential deflection of the 7-ply half-lapped joint.....	15
Figure 19. Furnace temperature curve for the 7-ply half-lapped joint (average values).....	15
Figure 20. Temperature profiles for the 7-ply half-lapped joint (average values).....	16
Figure 21. Temperature profiles at the half-lapped joint of the 7-ply CLT.....	16
Figure 22. 3-ply internal spline load and deflection measurements.....	17
Figure 23. Failure of the 3-ply internal spline	18
Figure 24. 5-ply internal spline load and deflection measurements.....	19
Figure 25. Failure of the 5-ply internal spline	19
Figure 26. Furnace temperature curve for the 5-ply internal spline (average values).....	20
Figure 27. Temperature profiles for the 5-ply internal spline (average values).....	20
Figure 28. Temperature profiles at the internal spline of the 5-ply CLT (average values).....	21
Figure 29. 3-ply single surface spline load and deflection measurements.....	22
Figure 30. Furnace temperature for the 3-ply single surface spline (average values)	23
Figure 31. Temperature profiles for the 3-ply single surface spline (average values).....	23
Figure 32. Temperature profiles at the single surface spline of the 3-ply CLT.....	24
Figure 33. 5-ply single surface spline load and deflection measurements.....	25
Figure 34. Furnace temperature curve for the 5-ply single surface spline (average values).....	26
Figure 35. Temperature profiles for the 5-ply single surface spline (average values).....	26
Figure 36. 3-ply double surface spline load and deflection measurements	27
Figure 37. Failure of the 3-ply double surface splines.....	28
Figure 38. Furnace temperature curve for the 3-ply double surface spline (average values)	29
Figure 39. Temperature profiles for the 3-ply double surface spline (average values)	29
Figure 40. Temperature profiles at the surface splines of the 3-ply CLT (average values).....	30

Figure 41. 5-ply double surface spline load and deflection measurements 31

Figure 42. Failure of the 5-ply double surface spline..... 31

Figure 43. Furnace temperature curve for the 5-ply double surface spline (average values) 32

Figure 44. Temperature profiles for the 5-ply double surface spline (average values) 33

Figure 45. Temperature profiles at the surface splines of the 5-ply CLT (average values)..... 33

Figure 46. 7-ply double surface spline load and deflection measurements 34

Figure 47. Burn-through along the perimeter of the 7-ply double surface spline 34

Figure 48. Furnace temperature curve for the 7-ply double surface spline (average values) 35

Figure 49. Temperature profiles for the 7-ply double surface spline (average values) 36

Figure 50. Temperature profiles at the surface splines of the 7-ply CLT (average values)..... 36

1 OBJECTIVE

The current study aims at evaluating the integrity failure (i.e. passage of hot gases or flames through the assembly) of CLT assemblies connected together using four types of commonly used panel-to-panel joints when exposed to the standard CAN/ULC S101 “*Standard Method of Fire Endurance Tests of Building Construction Materials*” [1] fire resistance time-temperature curve. The four types of joints include: 1) half-lapped, 2) internal spline, 3) single surface spline and 4) double surface splines.

2 BACKGROUND

Structural fire performance of building assemblies are assessed by conducting fire-resistance tests in accordance with CAN/ULC S101. A fire-resistance rating is defined as the period of time a building element, component, or assembly maintains the ability to perform its separating function (i.e. integrity and insulation), continues to perform a given load-bearing function (mechanical resistance), or both, when exposed to fire under specified conditions of test and performance criteria. Designers should be capable of accurately verifying both the load-bearing and separating functions of cross-laminated timber (CLT) as floor or wall slab assemblies in accordance with fire-related provisions of the building codes.

Integrity is one of the two requirements of the separating function of building assemblies (insulation being the other requirement). The time at which a CLT panel-to-panel joint can no longer prevent the passage of flame or gases hot enough to ignite a cotton pad defines its integrity fire resistance, as per CAN/ULC-S101. This requirement is essential in meeting Code objectives and functional statements, namely with respect to limiting the risk of fire spread to compartments beyond the compartment of fire origin.

As described in the 2014 Chapter 8 of the CLT Handbook [2], CLT panel-to-panel joint performance depends on its configuration and connection details; an integrity failure may occur when the connection detail can no longer withstand the applied load in either shear or withdrawal. CSA O86 “*Engineering Design in Wood*” [3] provides design provisions for connections with respect to minimum fastener penetrations for developing adequate lateral and withdrawal resistance. For instance, when using wood screws to connect CLT panels together, a minimum penetration no less than 5 times the wood screw diameter is required for single shear connections. As such, proper engineering and detailing of connections are fundamental.

So far, half-lapped joints have been evaluated in full-scale fire tests where the joint was located at mid-depth of the CLT panels and overlapped for at least 64 mm [4]. The joints were fastened using self-tapping wood screws of 90 mm (3½ in.), 160 mm (6¼ in.), and 220 mm (8¾ in.) for CLT assemblies made of 3, 5 and 7 plies respectively. A bead of construction adhesive was also used to ensure that the joint was sealed. Full-scale fire testing of CLT assemblies showed that integrity seems to be the predominant failure mode of CLT floor assemblies under load (i.e. flaming through the CLT panel-to-panel half-lapped joint). This failure mode was not observed in CLT wall assemblies under load. Walls usually buckle due to increasing second-order effects (i.e. P-Δ effects) as the section chars. According to the 2014 Chapter 8 of the CLT Handbook [2], the integrity failure time of a half-lapped joint located at mid-depth can be determined from Equation (1)

$$t_{\text{int}} = K_j \cdot \frac{h}{\beta_0} \quad (1)$$

Where K_j is a joint coefficient (taken as 0.35 for half-lapped joints at mid-depth), h is the total initial thickness (mm) and β_0 is the one-dimensional charring rate (mm/min). This model is based on the European approach given in Eurocode 5:1-2 “*Design of timber structures - Part 1-2: General - Structural fire design*” [5] applicable to the effect of joints in wood-based panels that are not backed by battens (i.e. unexposed side not protected by wood paneling, structural element, concrete topping, etc.). According to this standard, a joint coefficient of 0.3 is assigned for a half-lapped joint and 0.4 for an internal spline. This coefficient currently does not address single or double splines. Furthermore, a joint coefficient of unity ($K_j = 1.0$) can be taken when panel joints are fixed to a batten of at least the same thickness or to a structural element or when wood paneling is installed on the unexposed side. It is noted that these coefficients have been derived based on the fire behaviour of solid timber components, which may not necessarily be applicable to CLT slabs that may exhibit heat delamination (i.e. increased charring when compared to solid timber).

However, connection details of CLT assemblies may also consist of other configurations such as single or double surface splines or internal spline(s). These tightly fitted joint profiles should provide sufficient fire-resistance provided the loss in depth of the reduced cross-section has not yet reached the spline, but they have yet to be properly evaluated for fire-resistance in CLT assemblies. Therefore, evaluating and developing a joint coefficient (K_j) for these types of joints is needed.

Lastly, O’Neil [6] evaluated the fire performance of timber floors and recommended using a minimum residual thickness of 15 mm to be used as a “safe” approximation for meeting the insulation and integrity criteria simultaneously. Specifying a minimum residual thickness allows for ensuring the unexposed surface to remain within the limits prescribed in standard fire-resistance tests. This value is in agreement with the thermal model developed by Janssens & White [7]. According to their model, the remaining CLT thickness required to keep the average unexposed temperature increase below 140°C (or a temperature of about 160°C at a single point) would be 12 mm.

3 TECHNICAL TEAM

Christian Dagenais, Eng, M.Sc	Scientist, Serviceability & Fire Performance
Lindsay Osborne, M.A.Sc	Scientist, Serviceability & Fire Performance
Conroy Lum, P.Eng.	Research Leader, Structural Performance
Olivier Baes	Principal Technologist
Anes Omeranovic	Principal Technologist
	Advanced Building Systems, FPIInnovations

Assembly and instrumentation of the CLT panels were done at FPIInnovations Materials Evaluation laboratory in Quebec City. Fire testing was conducted at the Fire Research Facilities of Carleton University in Carleton Place, Ontario.

4 MATERIALS AND METHODS

4.1 Fire Testing

Intermediate-scale fire-resistance tests were carried out in a furnace recently constructed at the Fire Research Facilities of Carleton University in Ottawa, Ontario (Figure 1). The furnace is designed to accommodate specimens up to 4.8 m long by 1.06 m wide. A hydraulic jack is mounted above which can apply a load on the CLT panels in one-way bending up to a 200 mm maximum deflection. A two-point loading condition was chosen. The loading heads were free to rotate (i.e. roller bearing point) and were located at 1627 mm from the supports. This loading condition generates withdrawal stress at the fasteners located between the loading points (shear-free zone under the maximum bending moment) and longitudinal shear stresses along the fasteners located outside the loading points (constant shear stress). The manually controlled fire exposure followed, as close as possible, the CAN/ULC S101 standard time-temperature curve.

Table 1 summarizes the test matrix in this study. A total of ten specimens were tested using different panel-to-panel joint details. Given the fact that 7-ply CLT are most likely to be used for either long spans or high loading conditions, it was decided not to test the internal and single surface spline details for these 7-ply specimens. This is because the capacities of these details in 7-ply CLT are likely to be limited by the plywood spline capacity. Figure 2 shows the actual joint details evaluated in this study.



Figure 1. Intermediate-scale furnace at Carleton University

Table 1 – Test matrix

CLT Assembly	Panel-to-panel joint detail			
	Half-lapped	Internal Spline	Single surface spline	Double surface splines
3-ply (105 mm)	X	X	X	X
5-ply (175 mm)	X	X	X	X
7-ply (245 mm)	X	-	-	X

The CLT specimens were two specimens of the E1 stress grade conforming to ANSI/APA PRG-320 standard [8, 9] joined side-by-side using partially-threaded self-tapping screws. For the half-lapped and internal spline configurations, partially-threaded ASSY® 3.0 Ecofast [10] with a 6 mm diameter and in lengths of 100, 160 and 240 mm were used for 3-ply, 5-ply and 7-ply CLT specimens respectively ($\phi 6 \times 100/60$ mm, $\phi 6 \times 160/70$ and $\phi 6 \times 240/70$). The same self-tapping screws, of 70 mm in length ($\phi 6 \times 70/42$), were used for all CLT specimens with the single and double spline configurations. Screws were spaced at 300 mm (12") on center for all specimens.

It is noted that the fire testing was conducted during winter, thus in very cold and dry conditions as the laboratory is not heated. The CLT specimens were not conditioned prior to the tests and in most tests their initial temperature was below freezing.

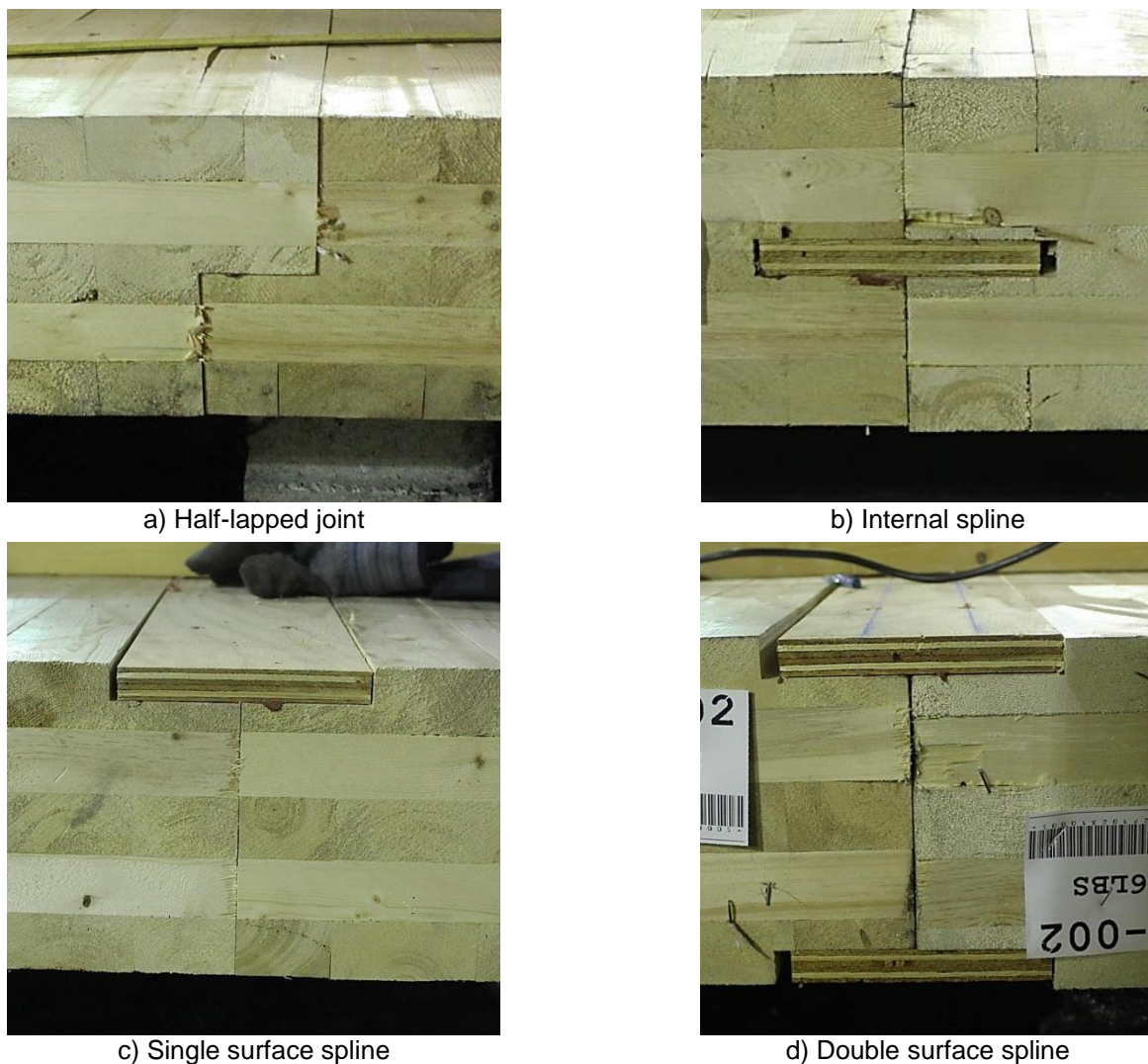

Figure 2. CLT panel-to-panel joint details

Except for the half-lapped joint configuration, all other panel-to-panel joints required the use of plywood splines to securely fasten the CLT panels together. The plywood splines were cut along the major strength direction of 1.22 x 2.44 m (4 x 8 ft.) sheets of Canadian softwood plywood (CSP) to

dimensions of 18.5 mm ($\frac{3}{4}$ in. nominal) in thickness and 130 mm ($5\frac{1}{8}$ in.) in width. Two plywood splines were butt-jointed together along their length (butt-joint located at mid-span). The CLT panels were machine-grooved at the manufacturing plant to accommodate for the joint details. Temperatures were measured throughout the CLT specimens and in the joints to obtain an accurate understanding of the heat transfer through the assemblies.

All joint assemblies were tightly fit and sealed using a 6 mm bead of Hilti FS-One intumescent firestop sealant [11] to prevent smoke leakage, as shown in Figure 3.



a) Half-lapped



b) Internal spline



c) Single surface spline



d) Double surface spline

Figure 3. Intumescent sealant used in the panel-to-panel joints

4.2 Spline Preliminary Evaluation

During the discussion to establish the loading protocol, some concerns were raised with respect to the proper way to achieve the study objective. As mentioned in section 1, the objective is to evaluate the integrity failure (i.e. passage of hot gases or flames through the assembly) of CLT assemblies connected together using four types of commonly used panel-to-panel joints during fire conditions. Typically, floor systems are to be evaluated for fire exposure from below (i.e. representing a fire occurring from a floor below).

Connections between CLT slabs are designed to solely transfer in-plane shear forces resulting from a floor diaphragm action or racking of CLT wall assemblies (for purposes of this report and given the fire test configuration, these will be referred to from this point onward as “horizontal shear forces”). These

connections, even if they have some ability to transfer vertical shear forces between the CLT slabs, are not designed for this function. The panel-to-panel joint details proposed in this study are meant to transfer horizontal forces between CLT slabs. The application of any horizontal load will result in a loading that forces horizontal sliding action between each CLT slab. This sliding action is the shear that is resulting from the floor responding as a diaphragm. Fasteners and splines serving as a link between any two CLT slabs are designed to resist this sliding action other loading effects are normally not taken into consideration.

As such, it was suggested to conduct preliminary bending tests under ambient conditions that would help develop a better understand of the behaviour of CLT splines subjected to a bending moment. The intent was to evaluate the potential failure mode and derive an adequate loading level during the fire tests as not to force premature failure of the fasteners or the plywood splines (force flame-through between the CLT panels).

The test setup consisted of a smaller-scale version of the fire test setup, that is a simple span of 3.5 m (138 in.) subjected to a two-point loading conditions. Each loading point was placed at one-third of the span, replicating a similar stress distribution as that used in the fire tests. Three CLT panels were connected side-by-side using the same single surface plywood spline and self-tapping screws as those used in the fire tests, and where the loads were applied only on the middle panel (Figure 4).



Figure 4. CLT bending test under ambient conditions

Two specimens were evaluated and exhibit very similar behaviour. As expected, the fasteners were the weakest link; the failure mode was the screw heads pulling through the plywood splines (Figure 5). This confirmed that the loading conditions used in the fire-resistance tests need to be such that failure of the fasteners will not occur prematurely (i.e. pull-through should not occur, but withdrawal or lateral crushing could, or simply burn-through at the joints).



Figure 5. Head pull-through in CLT bending test under ambient conditions

5 RESULTS

The following is a summary of the fire tests conducted on the 10 CLT panel-to-panel joints. In the first two tests (3-ply internal spline and half-lapped), some problems occurred during the testing either with the furnace, the thermocouples voltage reading or the loading jack. Monitoring of the burners as well as the loading jack was highly improved as the test series progressed. Each test is described further in detail in the following subsections.

5.1 Half-lapped Joint – 3-ply CLT

The 3-ply CLT with a half-lapped joint located at mid-depth was tested on December 3, 2014. The ambient conditions in the laboratory were -7°C and 39% relative humidity. The outdoor temperature was -3°C .

A load of 32 kN, representing a full loading condition, was applied prior to the fire exposure as shown in Figure 6. However, the bending stiffness of a 3-ply CLT floor slab is quickly reduced when the exposed layer in the strength direction chars. As such, the applied load was modified during the test. It can be seen that indeed the maximum 20 cm deflection was reached very early into the test. Nevertheless, the test continued until glowing at the unexposed surface was observed at the portion of the joint located between the loading points. The test failure time was recorded as 45 min.

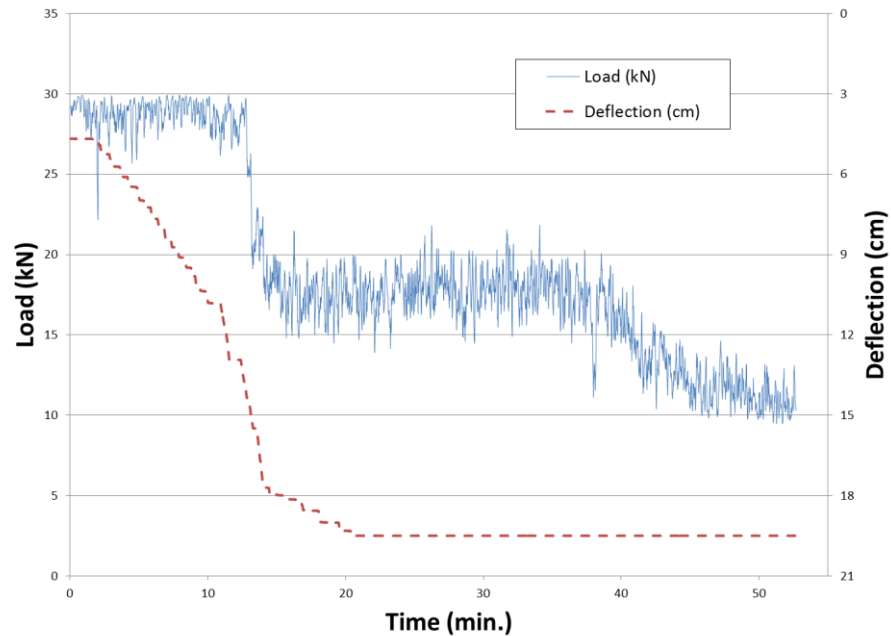

Figure 6. 3-ply half-lapped joint load and deflection measurements



Figure 7. Failure of the 3-ply half-lapped joint

Throughout the test, there were significant difficulties trying to properly following the standard fire curve, especially during the first 20 minutes as shown in Figure 8. Figure 9 and Figure 10 show the temperature profiles recorded throughout the CLT and at the junction of the half-lapped joint. The 300°C isotherm was reached at 17.5 mm after 28 min, yielding a charring rate of 0.63 mm/min. At the end of the test (at 53 min), the maximum temperature reading at the joint was 290°C, indicating that the char front (300°C isotherm) was very close to this point; this result gives a charring rate of 0.99 mm/min.

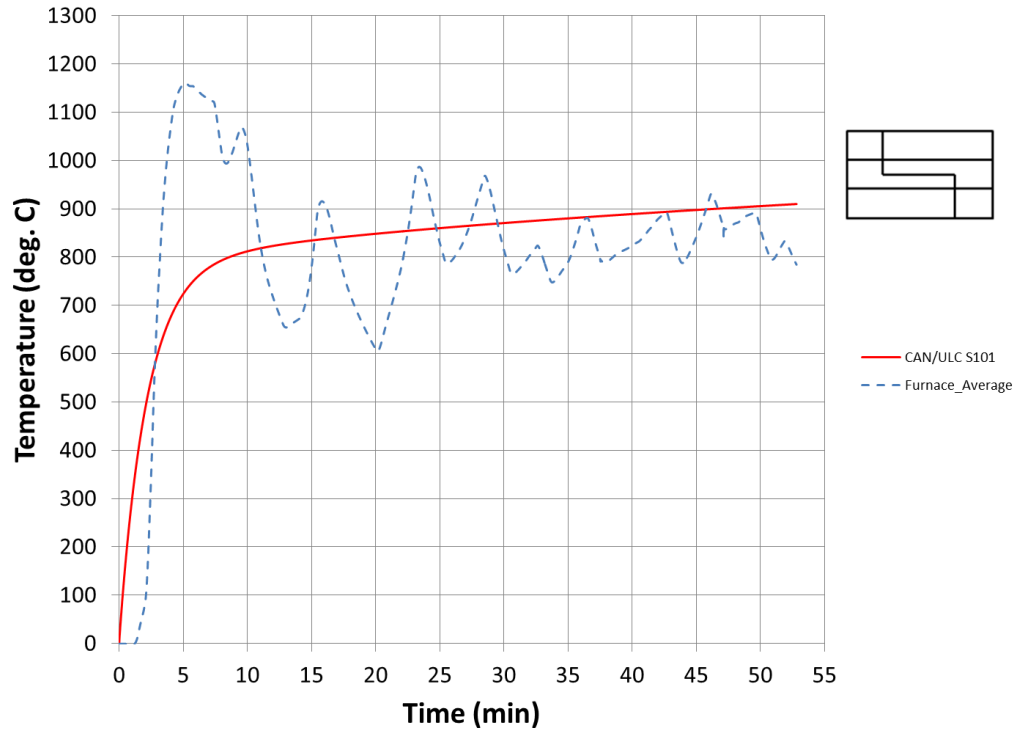

Figure 8. Furnace temperature for the 3-ply half-lapped joint (average values)

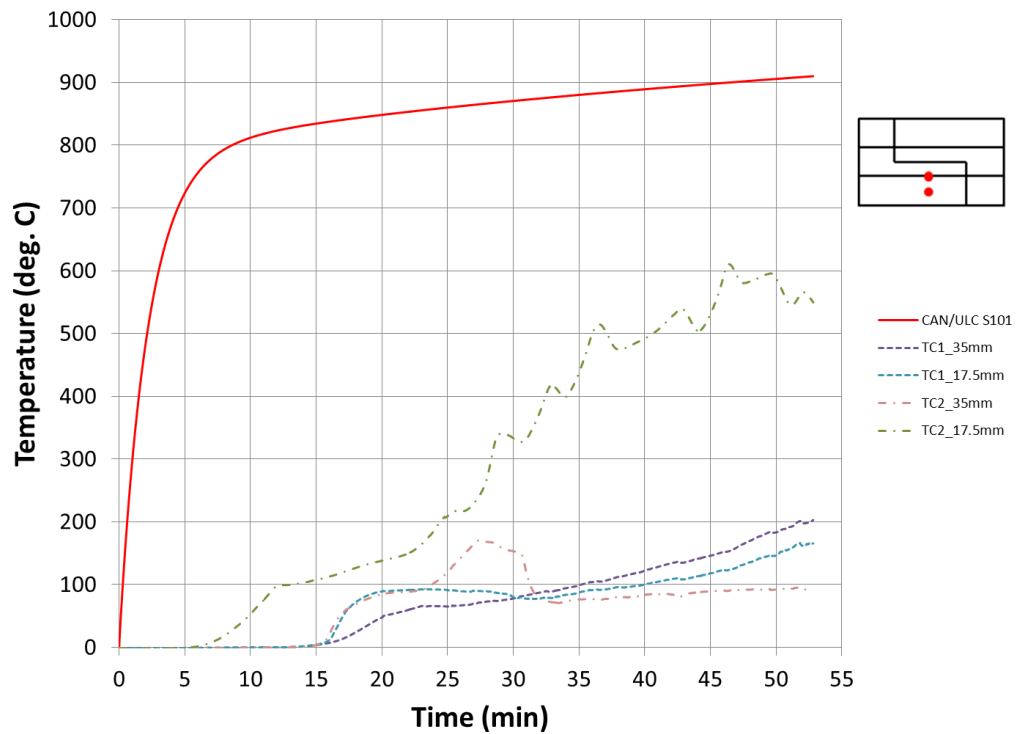

Figure 9. Temperature profiles for the 3-ply half-lapped joint

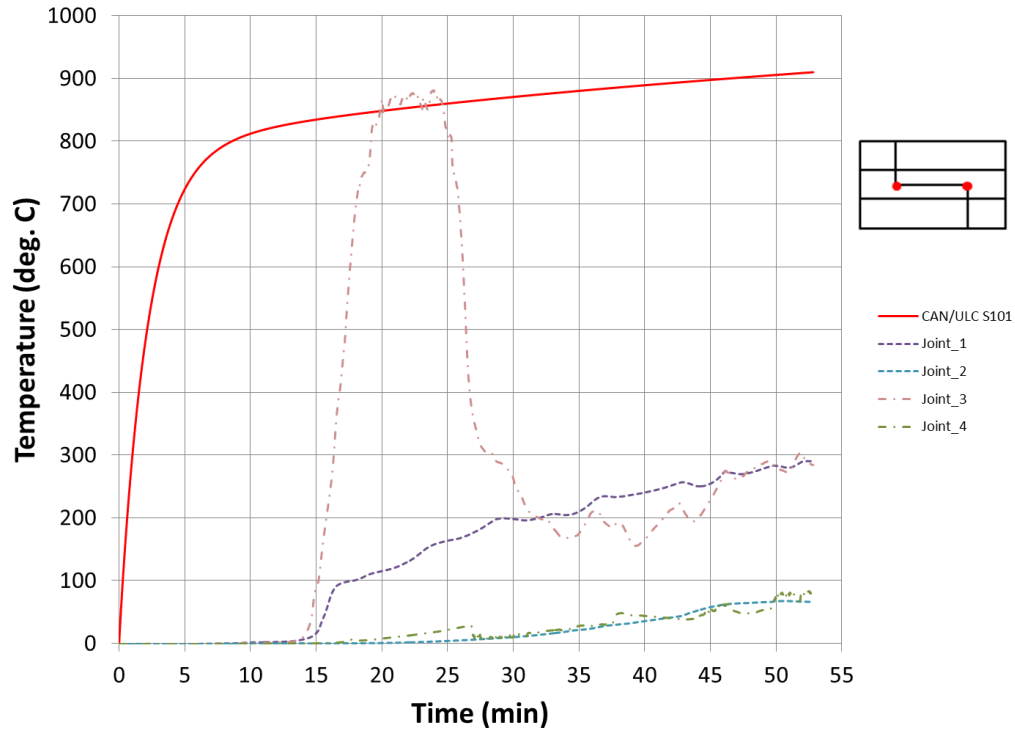

Figure 10. Temperature profiles at the half-lapped joint of the 3-ply CLT

5.2 Half-lapped Joint – 5-ply CLT

The 5-ply CLT with a half-lapped joint located at mid-depth was tested on February 6, 2015. The ambient conditions in the laboratory were -7°C and 43% relative humidity. The outdoor temperature was -7°C.

A load of 41 kN, representing a 54% loading condition determined from an initial 20 mm deflection, was applied prior to the fire exposure as shown in Figure 11. The test continued until differential deflection occurred between the 2 CLT panels (Figure 12). The test failure time was recorded as 98 min.

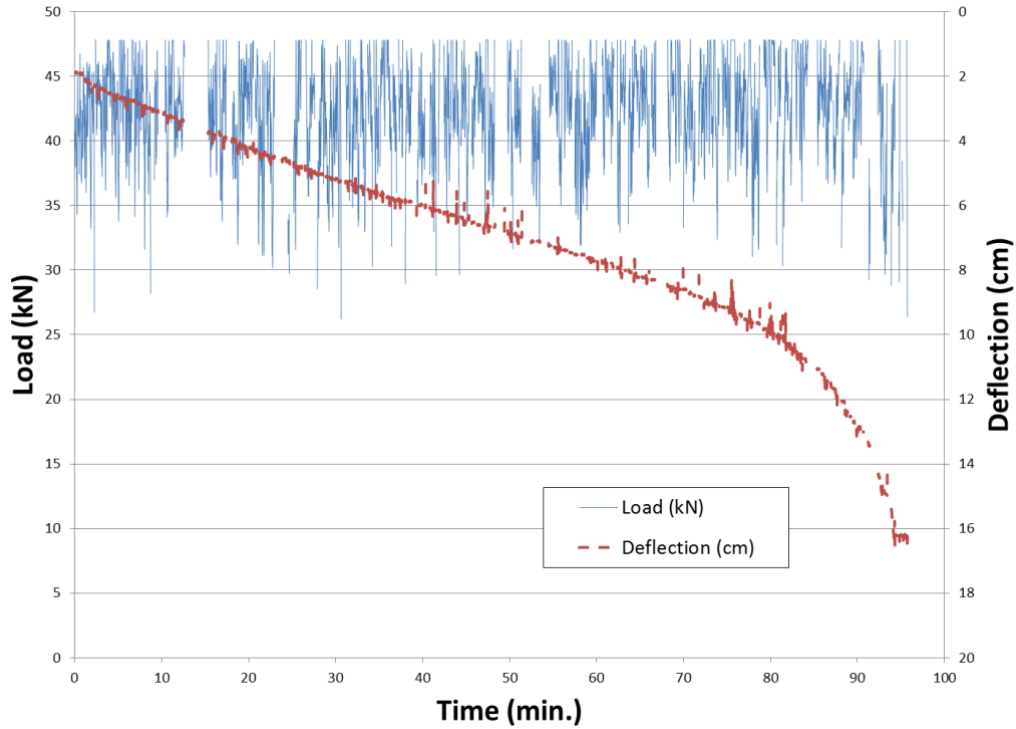

Figure 11. 5-ply half-lapped joint load and deflection measurements

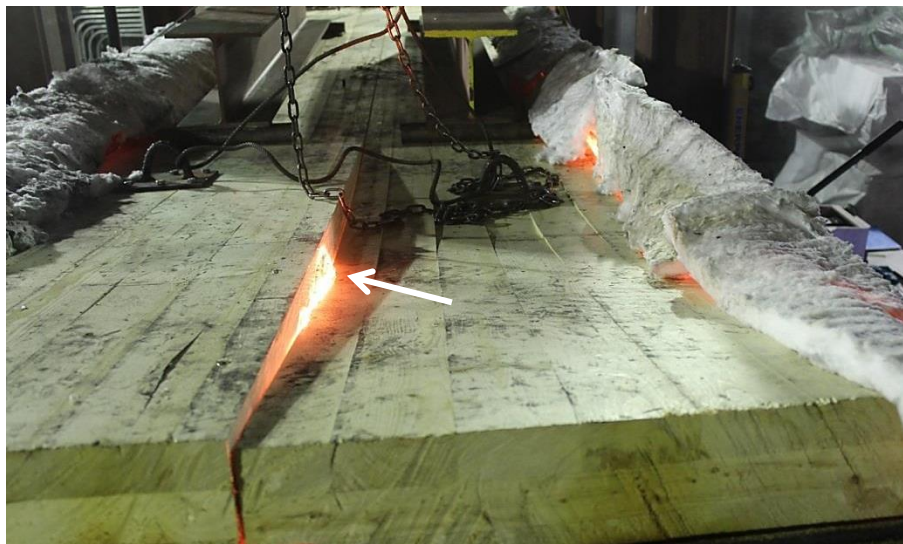

Figure 12. Failure of the 5-ply half-lapped joint

Figure 13 illustrates the temperature recorded inside the furnace during the test. It can be seen that the temperature, although lower for most of the test, followed closely the standard curve. Figure 14 and Figure 15 show the temperature profiles recorded throughout the CLT and at the junction of the half-lapped joint. The 300°C isotherm was reached at 17.5 mm and 35 mm after 51 min and 74 min, yielding a charring rate of 0.34 and 0.47 mm/min, respectively. As shown in Figure 15, no significant temperature rises were recorded at the 2nd glue line (70 mm) or at the joint interface.

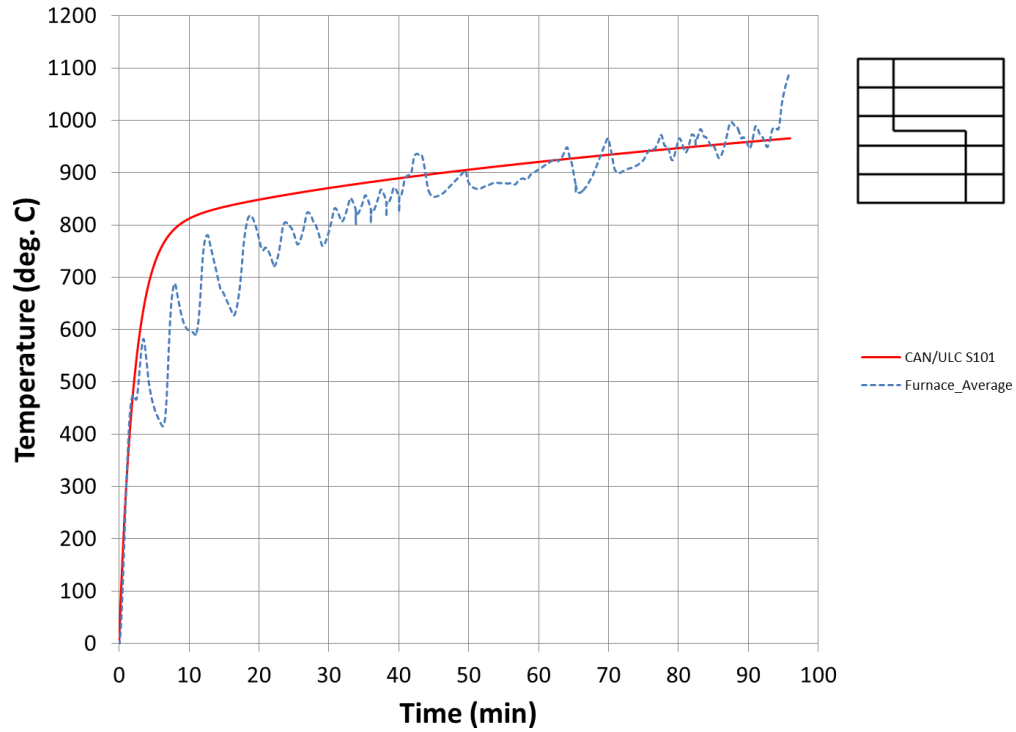

Figure 13. Furnace temperature curve for the 5-ply half-lapped joint (average values)

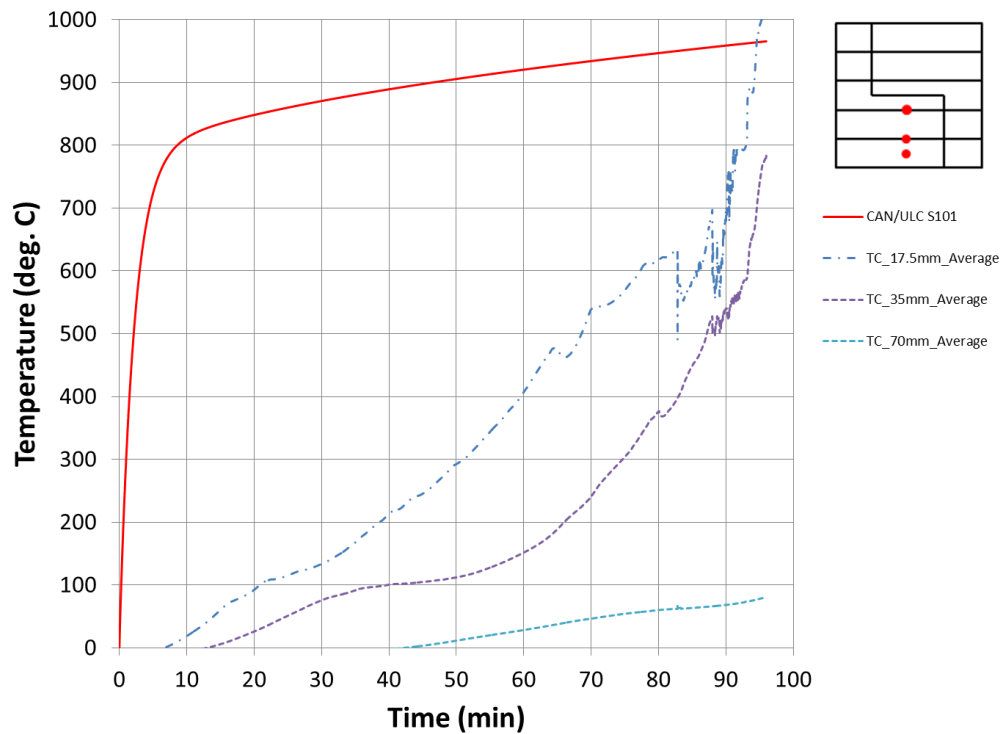

Figure 14. Temperature profiles for the 5-ply half-lapped joint (average values)

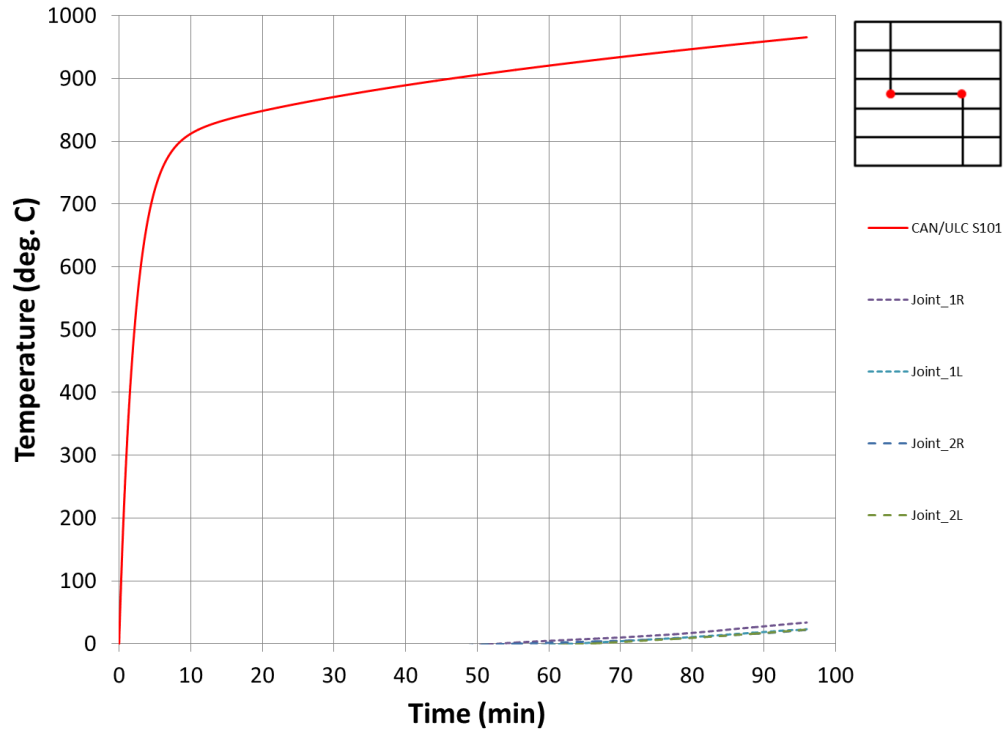

Figure 15. Temperature profiles at the half-lapped joint of the 5-ply CLT

5.3 Half-lapped Joint – 7-ply CLT

The 7-ply CLT with a half-lapped joint located at mid-depth was tested on March 12, 2015. The ambient conditions in the laboratory are unknown, but the outdoor temperature was -6°C.

A load of 50 kN, representing a 37% loading condition limited by the load cell capacity, was applied prior to the fire exposure (Figure 16). The test continued until glowing at the unexposed surface was observed at the portion of the joint located between the loading points, as shown in Figure 17. As with the 5-ply half-lapped test, differential deflection also occurred between the 2 CLT panels (Figure 18). The test failure time was recorded as 140 min.

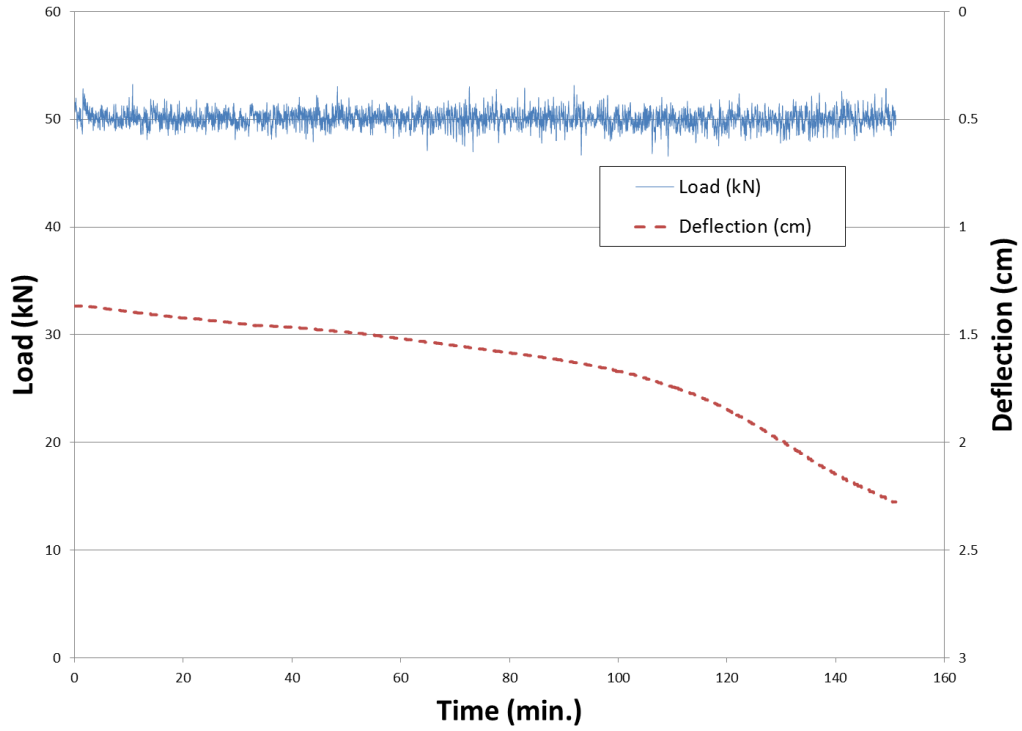

Figure 16. 7-ply half-lapped joint load and deflection measurements

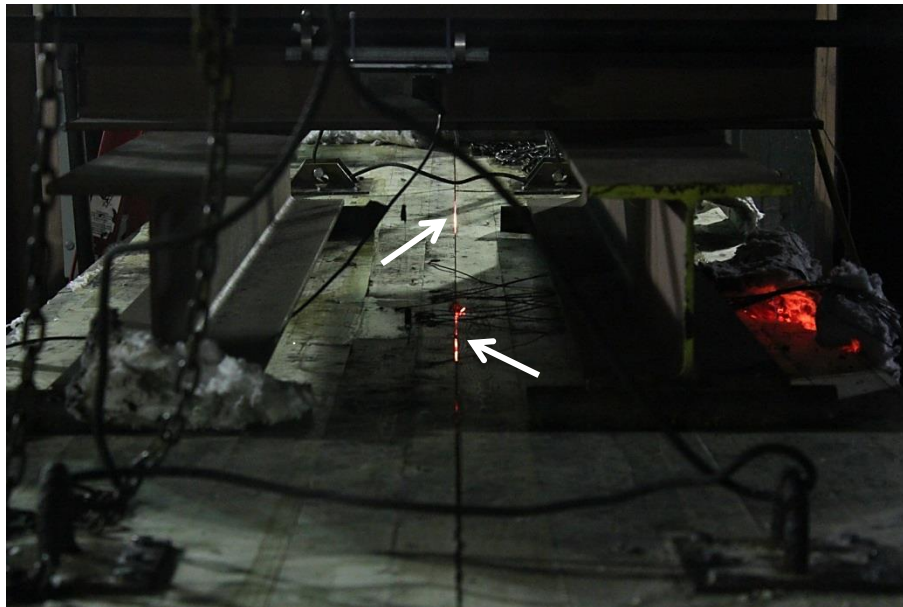

Figure 17. Failure of the 7-ply half-lapped joint



Figure 18. Differential deflection of the 7-ply half-lapped joint

Figure 19 illustrates the temperature recorded inside the furnace during the test. It can be seen that the temperature followed closely the standard curve. Figure 20 and Figure 21 show the temperature profiles recorded throughout the CLT and at the junction of the half-lapped joint. The 300°C isotherm was first reached at 17.5, 35, 70 and 105 mm after 47, 74, 117 and 144 min, yielding a charring rate of 0.37, 0.47, 0.60 and 0.73 mm/min respectively. The half-lapped interface reached 300°C at 96 min.

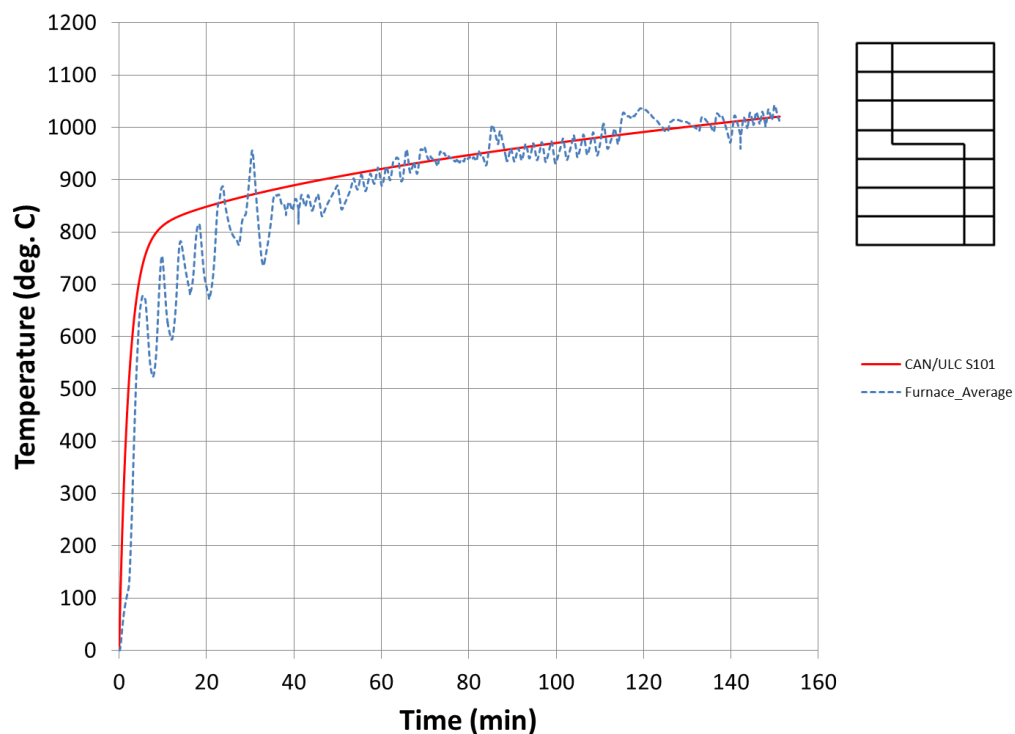

Figure 19. Furnace temperature curve for the 7-ply half-lapped joint (average values)

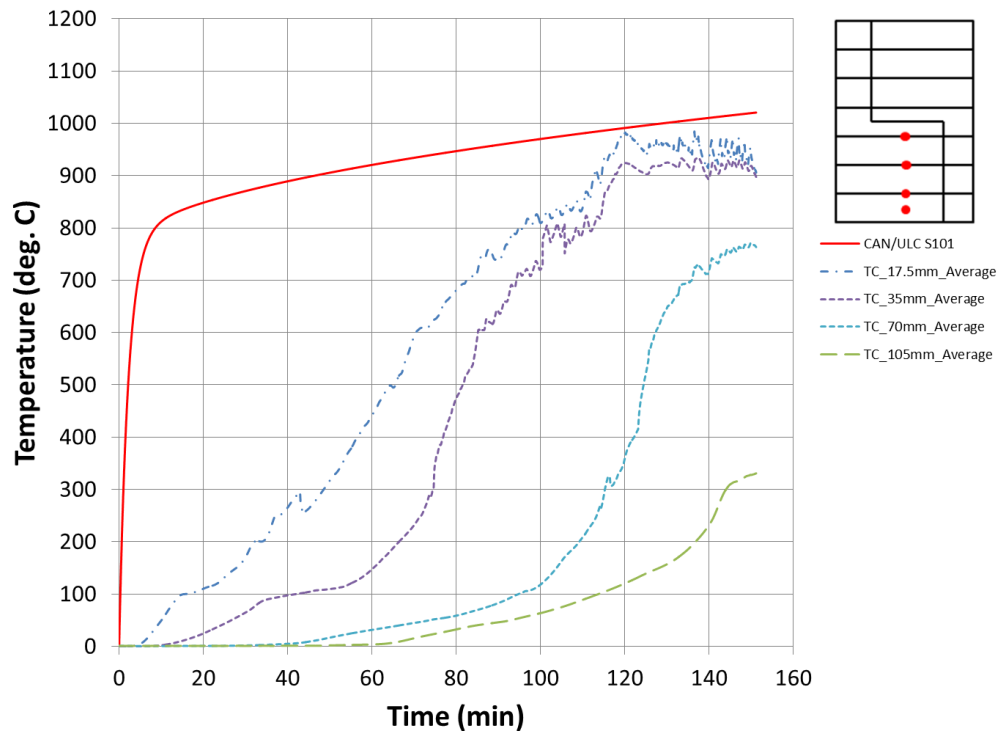

Figure 20. Temperature profiles for the 7-ply half-lapped joint (average values)

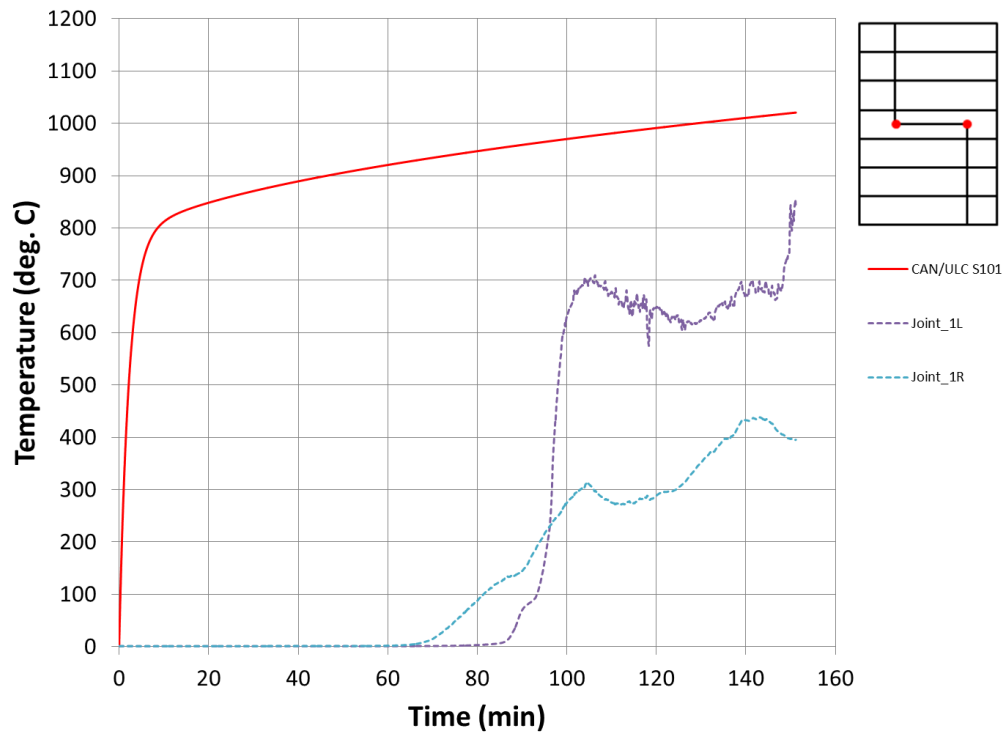

Figure 21. Temperature profiles at the half-lapped joint of the 7-ply CLT

5.4 Internal Spline – 3-ply CLT

The 3-ply CLT with an internal spline located at mid-depth was tested on November 19, 2014. The ambient conditions in the laboratory are unknown, but the outdoor temperature was -6°C.

A load of 32 kN, representing a full loading condition, was applied prior to the fire exposure (Figure 29). Significant problems occurred throughout the test, namely with the burners due to the very cold indoor conditions (problem in the air/propane mixture). In addition, problems with the data acquisition system occurred. As such, no data has been properly recorded for this specific test, including the furnace temperature.

However, from visual observations and manual timing, glowing at the surface (unexposed) was observed at the joint around 35 min after the test (Figure 23). The burn-through was located close to mid-span where the spline was butt-jointed. It is noted that since the burners were not controlled properly, the furnace temperature could not be verified.

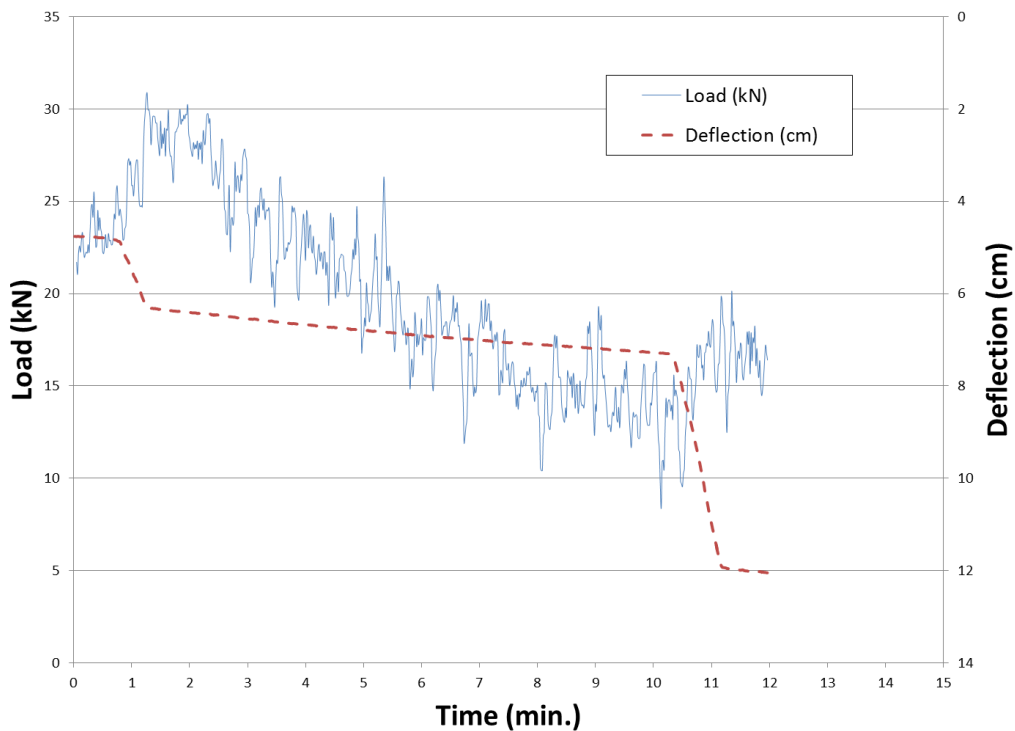

Figure 22. 3-ply internal spline load and deflection measurements

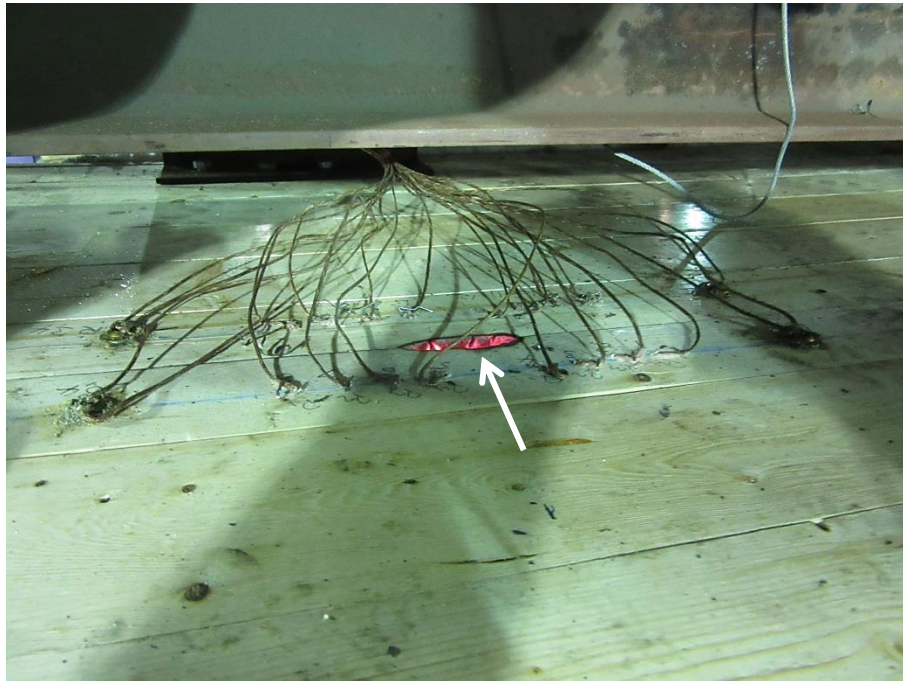

Figure 23. Failure of the 3-ply internal spline

5.5 Internal Spline – 5-ply CLT

The 5-ply CLT with an internal spline located at mid-depth was tested on January 30, 2015. The ambient conditions in the laboratory are unknown, but the outdoor temperature was -13°C.

A load of 42 kN, representing a 55% loading condition determined from an initial 20 mm deflection was applied prior to the fire exposure as shown in Figure 24. The test continued until glowing at the unexposed surface was observed at the joint, located at mid-span where the spline was butt-jointed, as shown in Figure 25. The test failure time was recorded as 76 min.

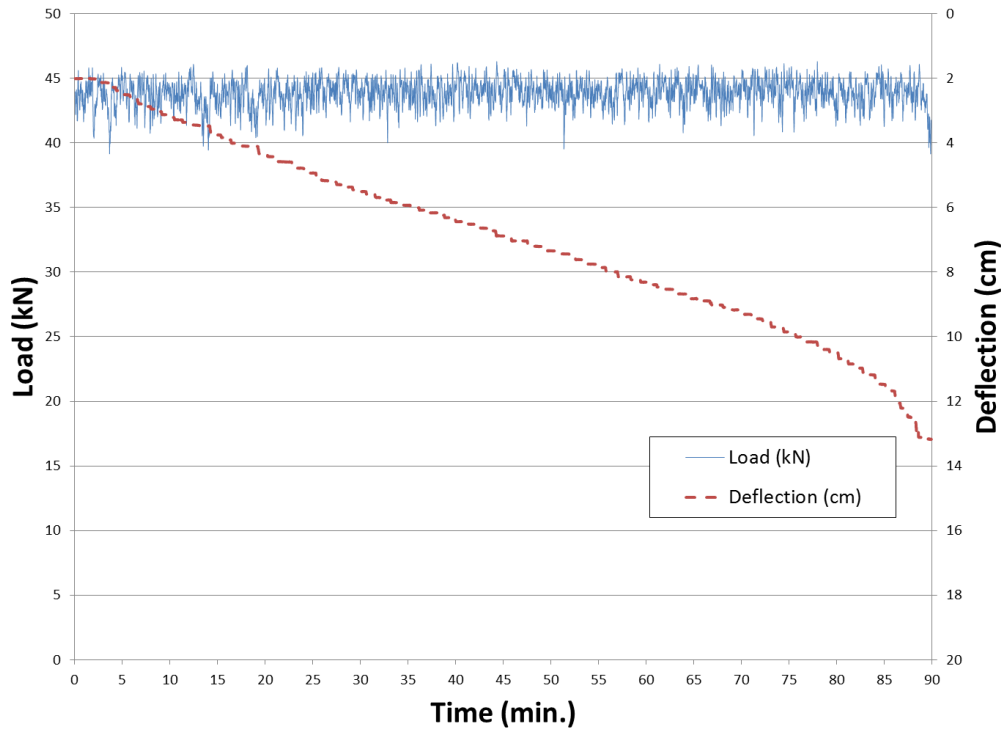

Figure 24. 5-ply internal spline load and deflection measurements



Figure 25. Failure of the 5-ply internal spline

Figure 30 illustrates the temperature recorded inside the furnace during the test. It can be seen that the temperature was lower for most of the test but followed closely the standard curve. Figure 27 and Figure 28 show the temperature profiles recorded throughout the CLT and at the junction of the internal spline. The 300°C isotherm was reached at 17.5, 35 and 70 mm after 29, 61 and 85 min, yielding a charring rate of 0.60, 0.57 and 0.82 mm/min respectively. The bottom and the top of the internal spline reached 300°C respectively at 75 and 81 min.

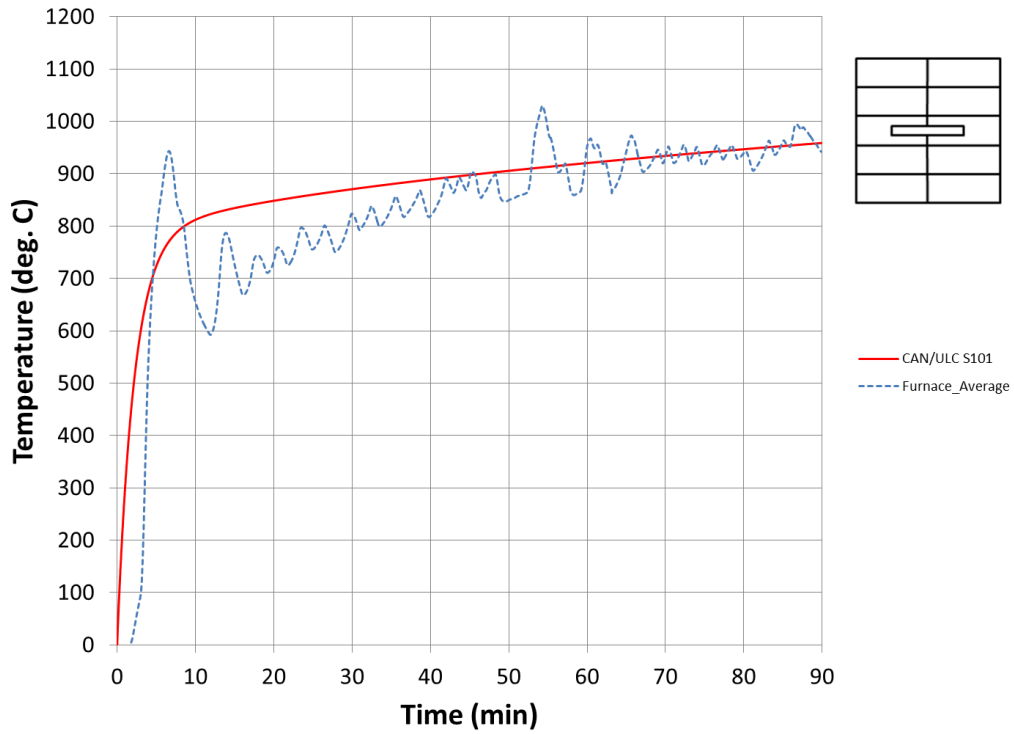

Figure 26. Furnace temperature curve for the 5-ply internal spline (average values)

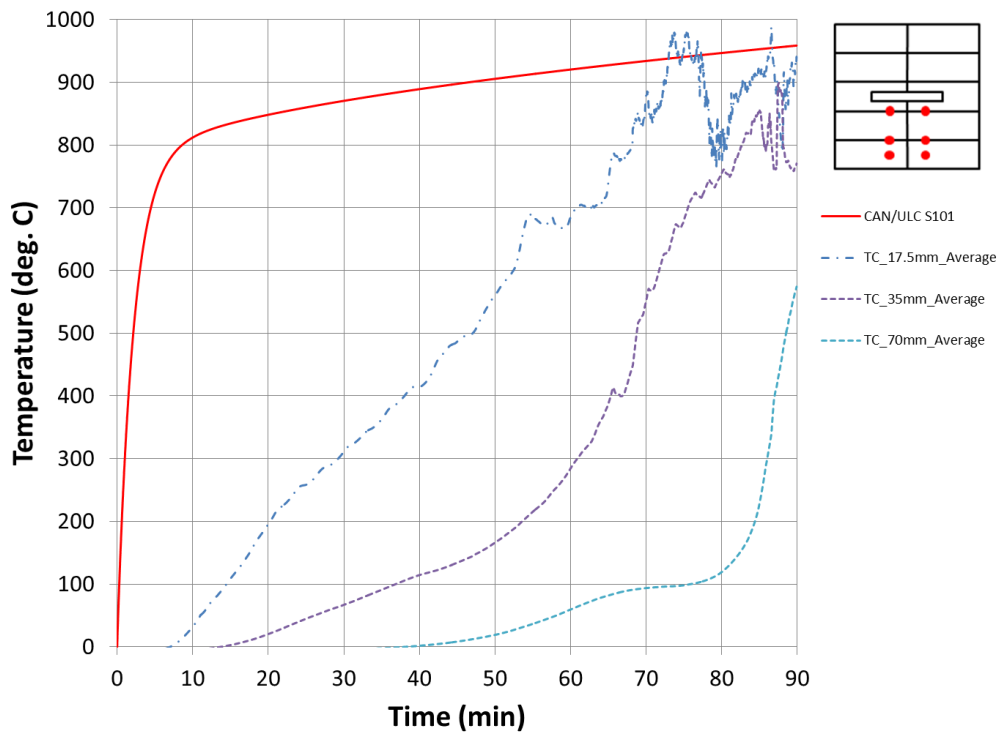

Figure 27. Temperature profiles for the 5-ply internal spline (average values)

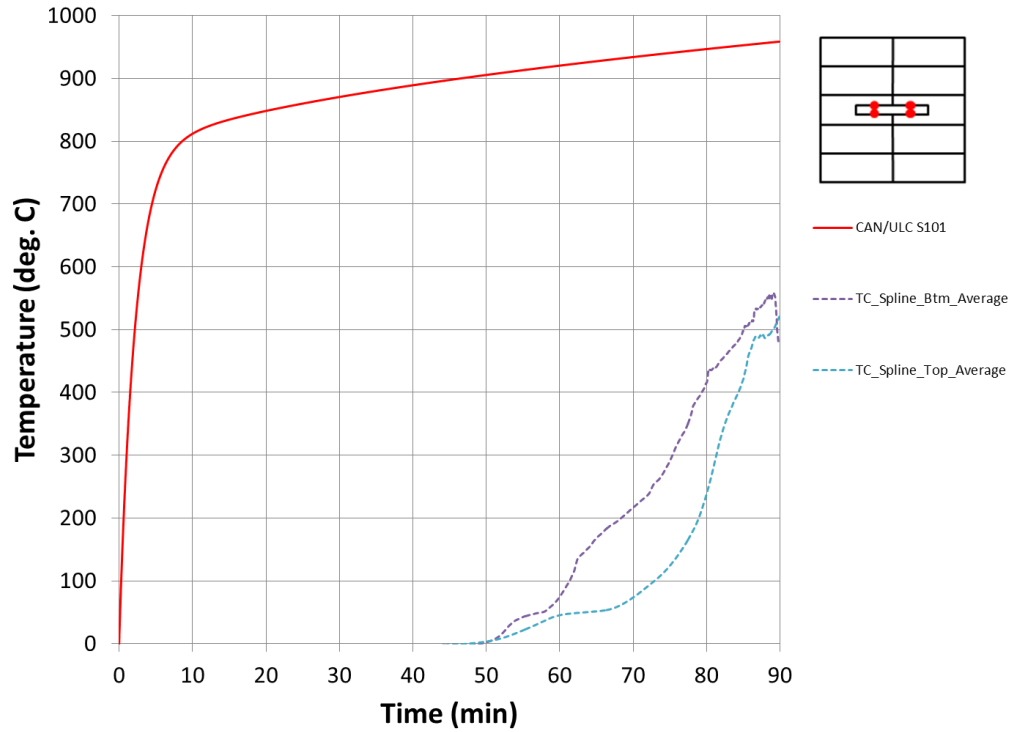

Figure 28. Temperature profiles at the internal spline of the 5-ply CLT (average values)

5.6 Single Surface Spline – 3 ply CLT

The 3-ply CLT with a single surface spline was tested on December 9, 2014. The ambient conditions in the laboratory were 2°C and 58% relative humidity. The outdoor temperature was -3°C.

A load of 32 kN, representing a full loading condition, was applied. As explained in subsection 5.1 of this report, the maximum deflection (20 cm) was reached early in the test. After 54 min into the test, it was decided to end the test due to laboratory equipment safety concerns. As such, no failure time was recorded.

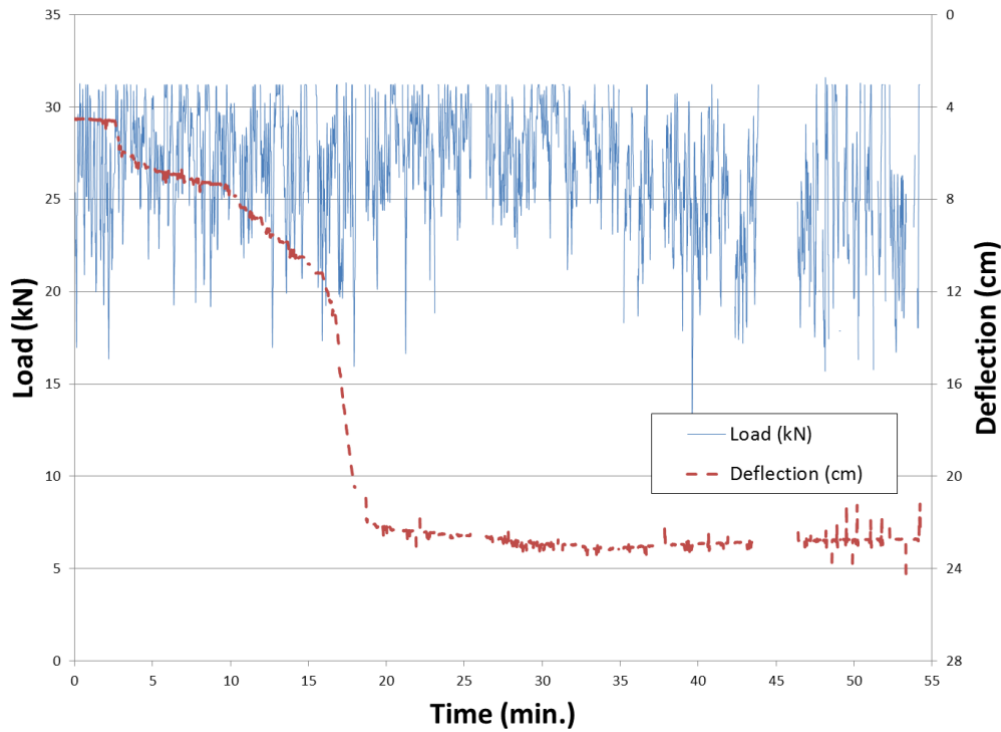

Figure 29. 3-ply single surface spline load and deflection measurements

Throughout the test, there were significant difficulties in properly following the standard fire curve (Figure 30). Figure 31 and Figure 32 show the temperature profiles recorded throughout the CLT and at the junction of the half-lapped joint. The 300°C isotherm was reached at 17.5 and 35 mm after 30 and 52 min, yielding a charring rate of 0.58 and 0.67 mm/min. No significant temperature rises were recorded at the 2nd glue line (70 mm) and at the joint interface, as shown in Figure 32.

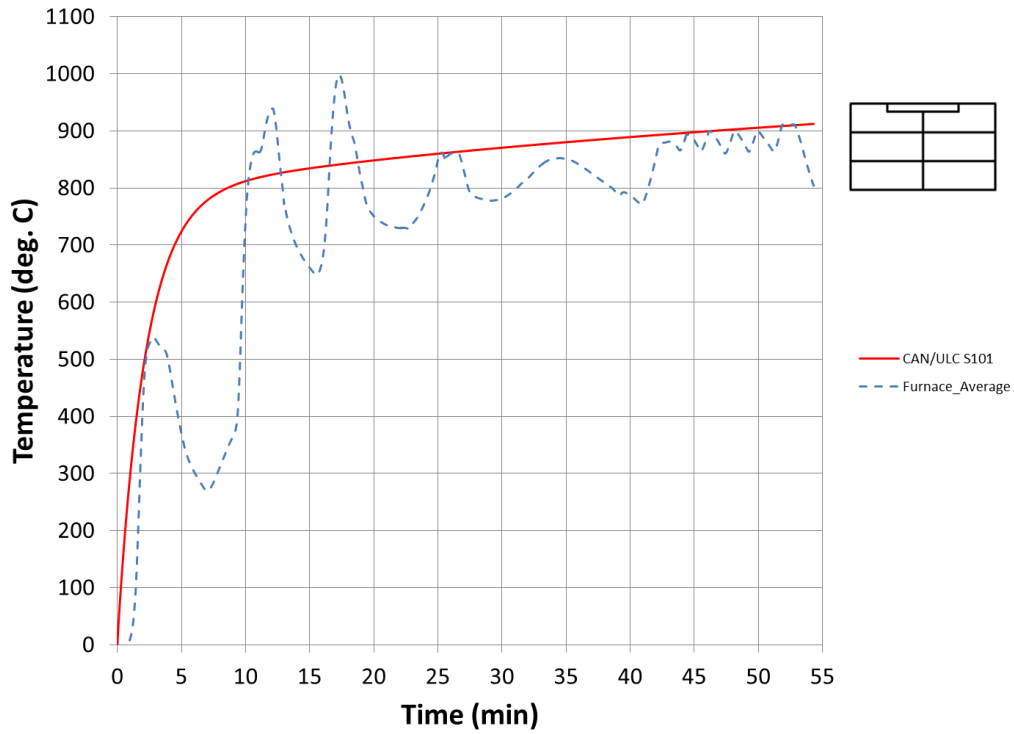

Figure 30. Furnace temperature for the 3-ply single surface spline (average values)

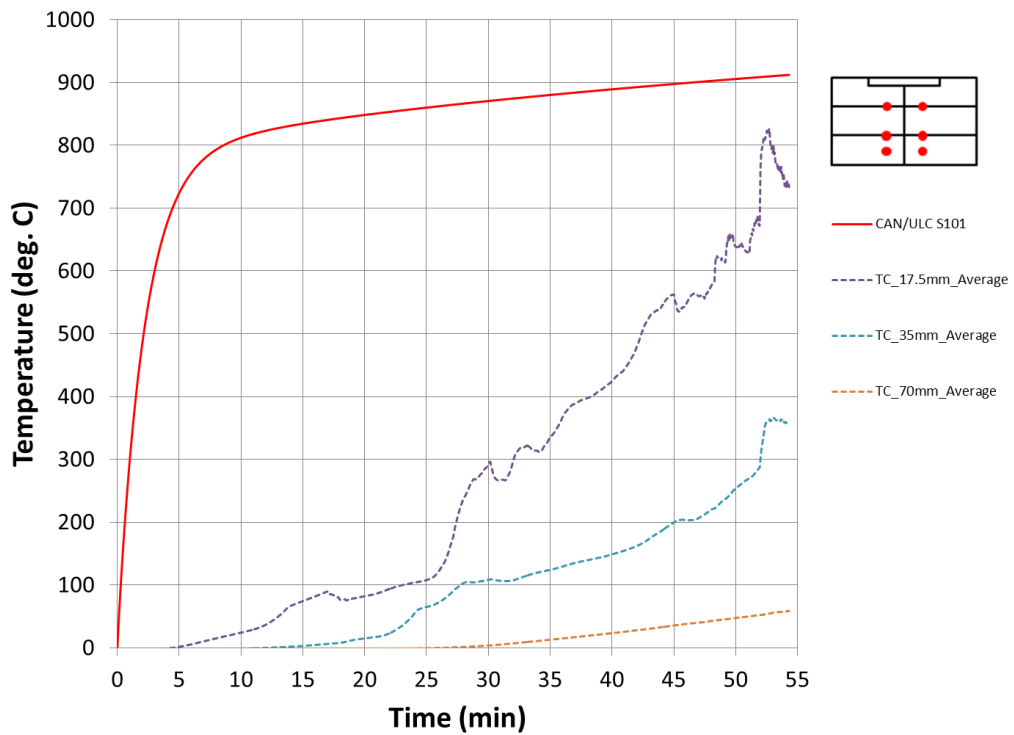

Figure 31. Temperature profiles for the 3-ply single surface spline (average values)

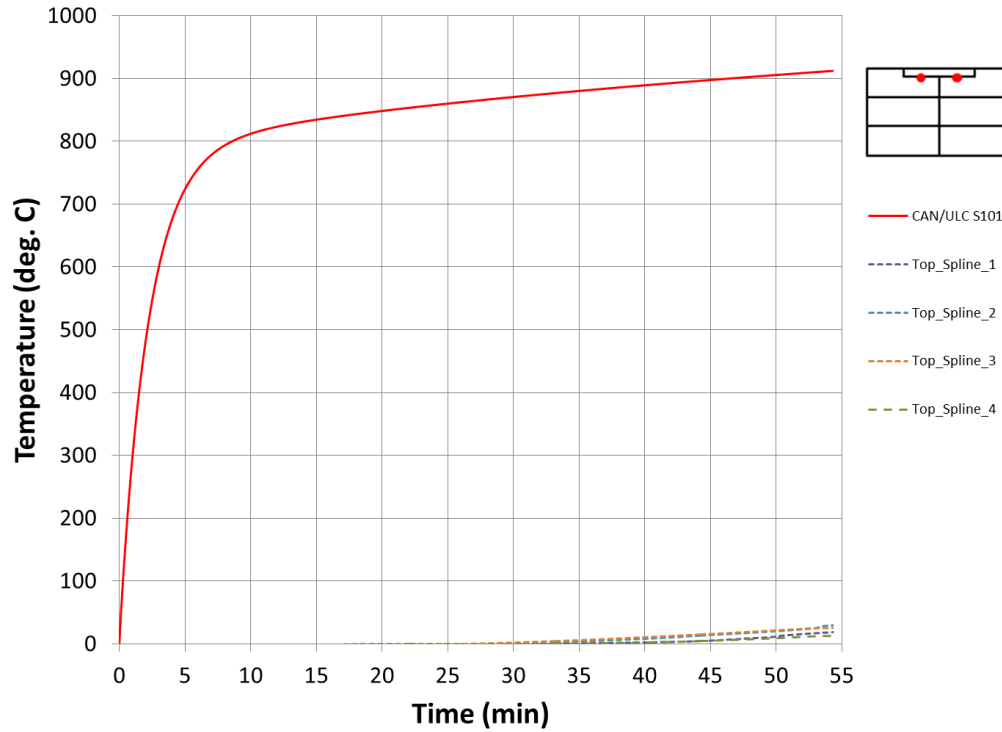

Figure 32. Temperature profiles at the single surface spline of the 3-ply CLT

5.7 Single Surface Spline – 5 ply CLT

The 5-ply CLT with a single surface spline located at the unexposed (top) surface was conducted on February 17, 2015. The ambient conditions in the laboratory were -11°C and 29% relative humidity. The outdoor temperature was -12°C.

A load of 42 kN, representing a 55% loading condition determined from an initial 20 mm deflection was applied as shown in Figure 11. After roughly 98 min, it was decided to end the test due to laboratory equipment safety concerns (several burn-through locations occurred along the sides of the specimen). As such, no failure time was recorded.

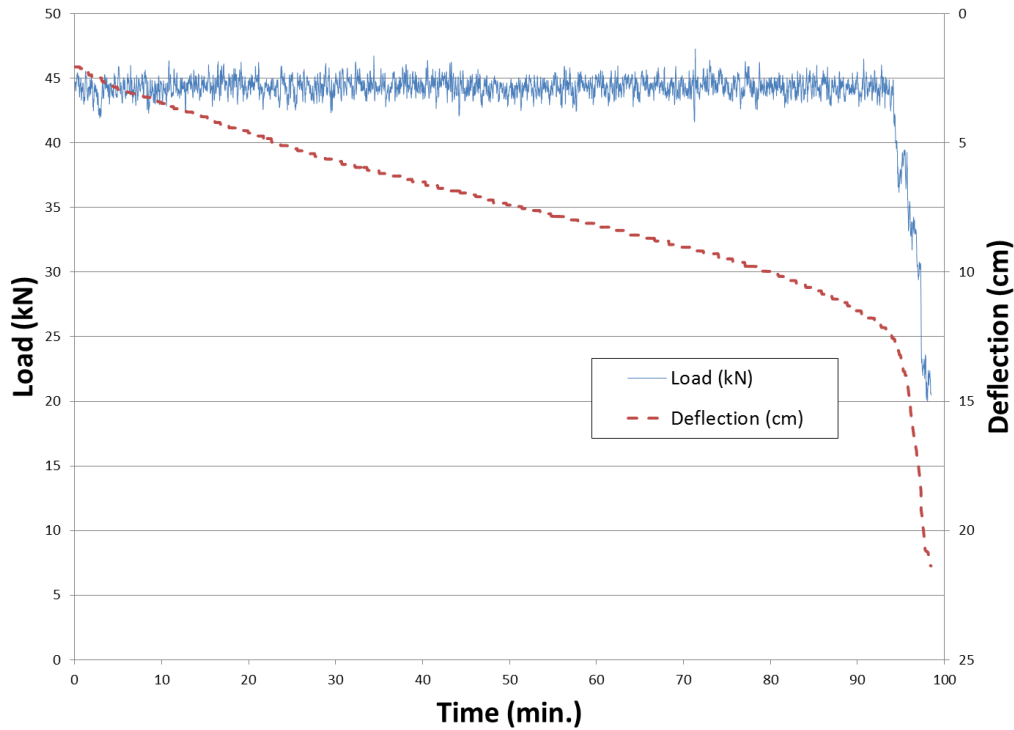

Figure 33. 5-ply single surface spline load and deflection measurements

Figure 34 illustrates the temperature recorded inside the furnace during the test. It can be seen that the temperature was slightly lower in general but followed closely the standard curve. Figure 35 shows the temperature profiles recorded throughout the CLT and at the junction of the surface spline. The 300°C isotherm was reached at 17.5 and 35 mm after 45 and 78 min, yielding a charring rate of 0.39 and 0.45 mm/min respectively. No significant temperature rises were recorded at the 2nd glue line (70 mm) and at the spline-CLT interface (thus not shown in Figure 35 beyond 70 mm).

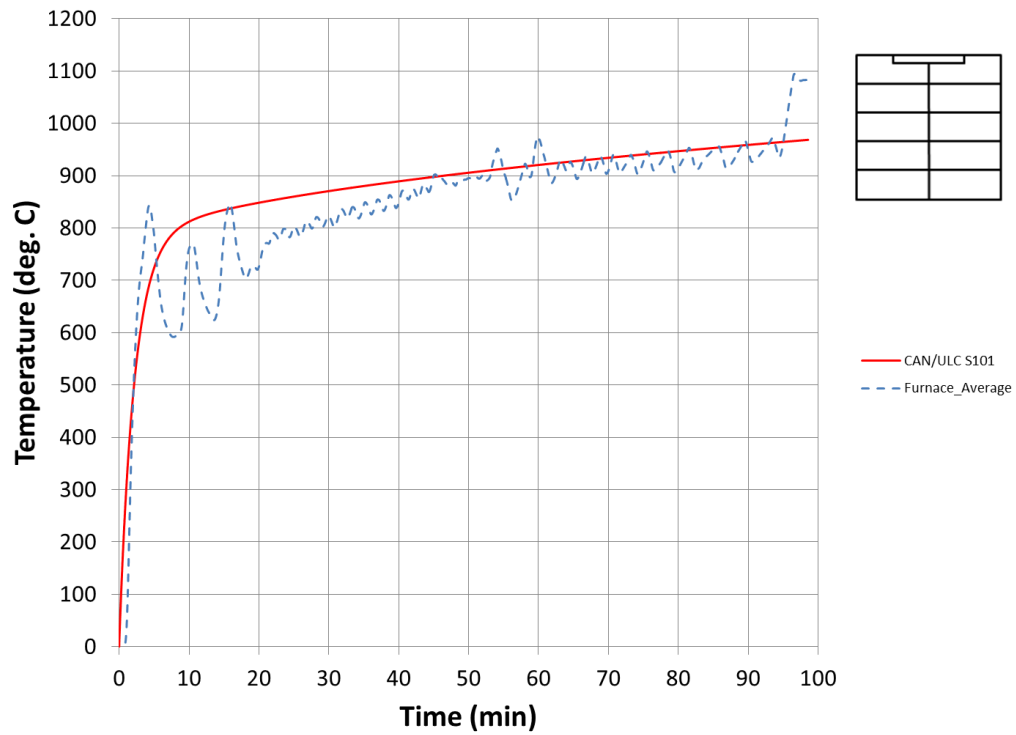

Figure 34. Furnace temperature curve for the 5-ply single surface spline (average values)

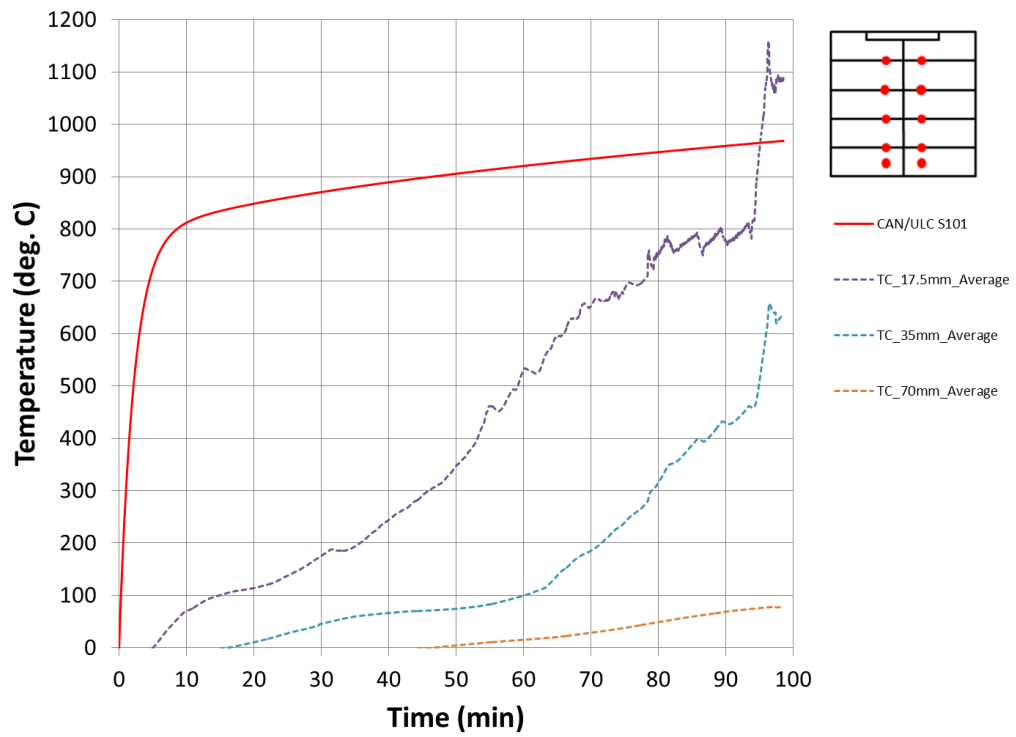

Figure 35. Temperature profiles for the 5-ply single surface spline (average values)

5.8 Double Surface Spline – 3 ply CLT

The 3-ply CLT with double surface splines was tested on December 16, 2014. The ambient conditions in the laboratory were 3°C and 75% relative humidity. The outdoor temperature was -2°C.

A load of 32 kN, representing a full loading condition, was applied (Figure 36). The test continued until glowing at the surface (unexposed) was observed at the portion of the joint located between the spline and the CLT, close to a loading point, as shown in Figure 37. The test failure time was recorded as 43 min.

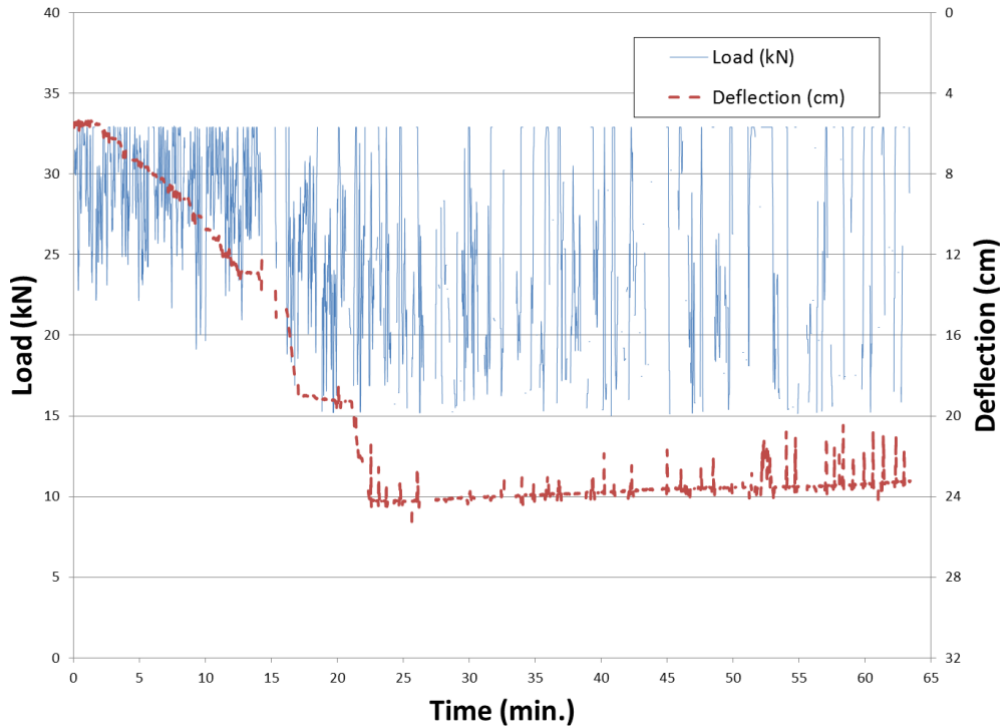

Figure 36. 3-ply double surface spline load and deflection measurements

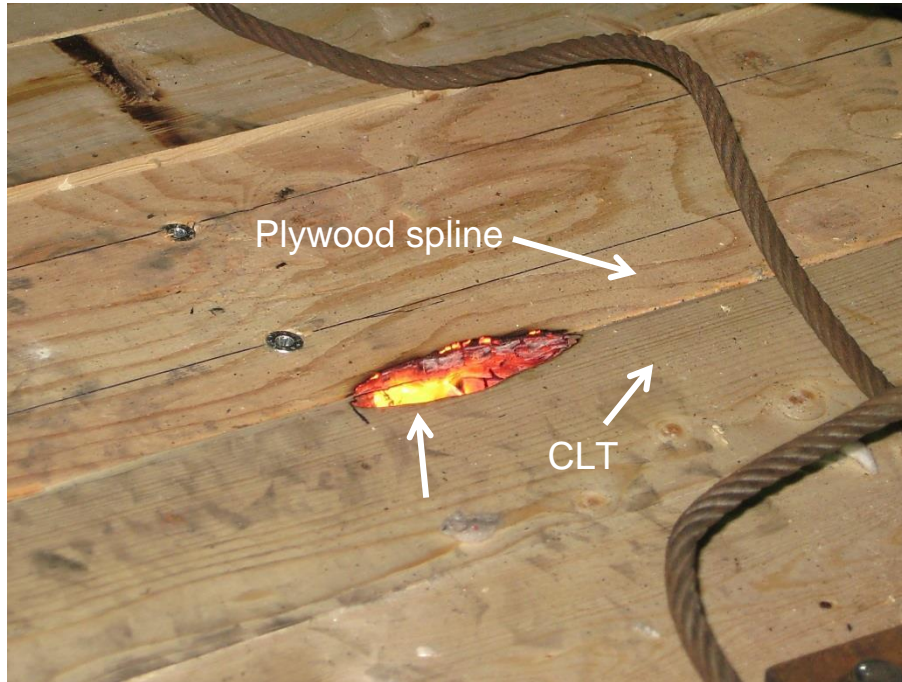

Figure 37. Failure of the 3-ply double surface splines

There were difficulties in attempting to properly follow the standard time-temperature curve as shown in Figure 38. Figure 39 and Figure 40 show the temperature profiles recorded throughout the CLT and at the junction of the surface splines (top and bottom). The 300°C isotherm was reached at 17.5 and 35 mm after 46 and 60 min, yielding to a charring rate of 0.38 and 0.58 mm/min. No significant temperature rises were recorded at the 2nd glue line (70 mm). The bottom spline reached 300°C at 28 min. No significant temperature rise was recorded underneath the top surface spline.

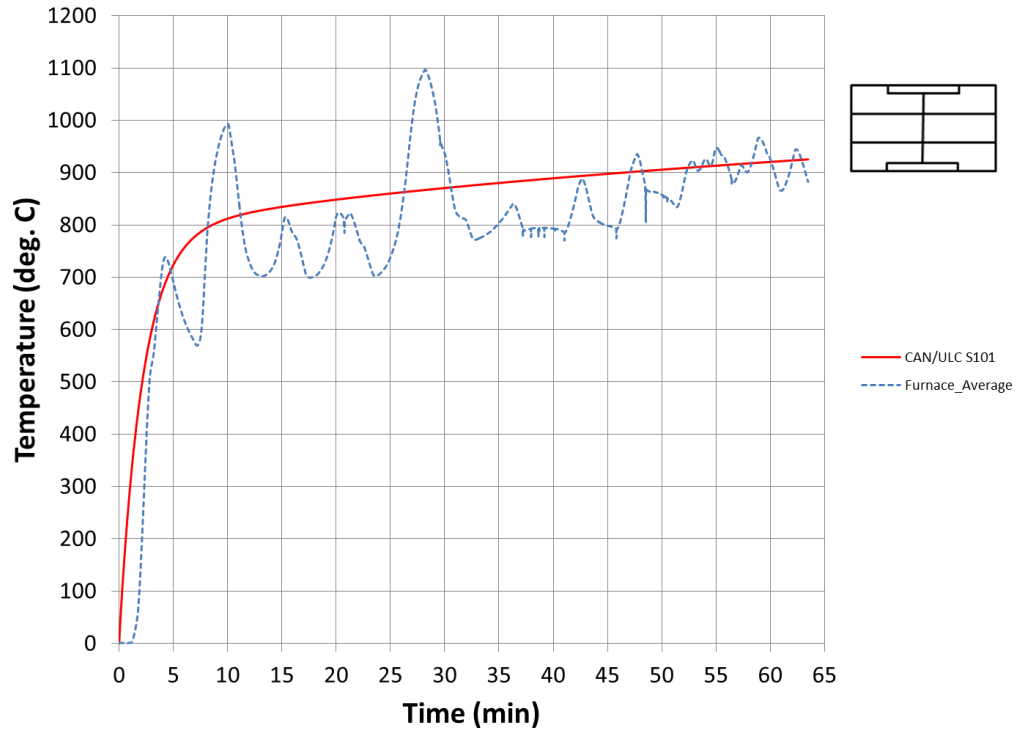

Figure 38. Furnace temperature curve for the 3-ply double surface spline (average values)

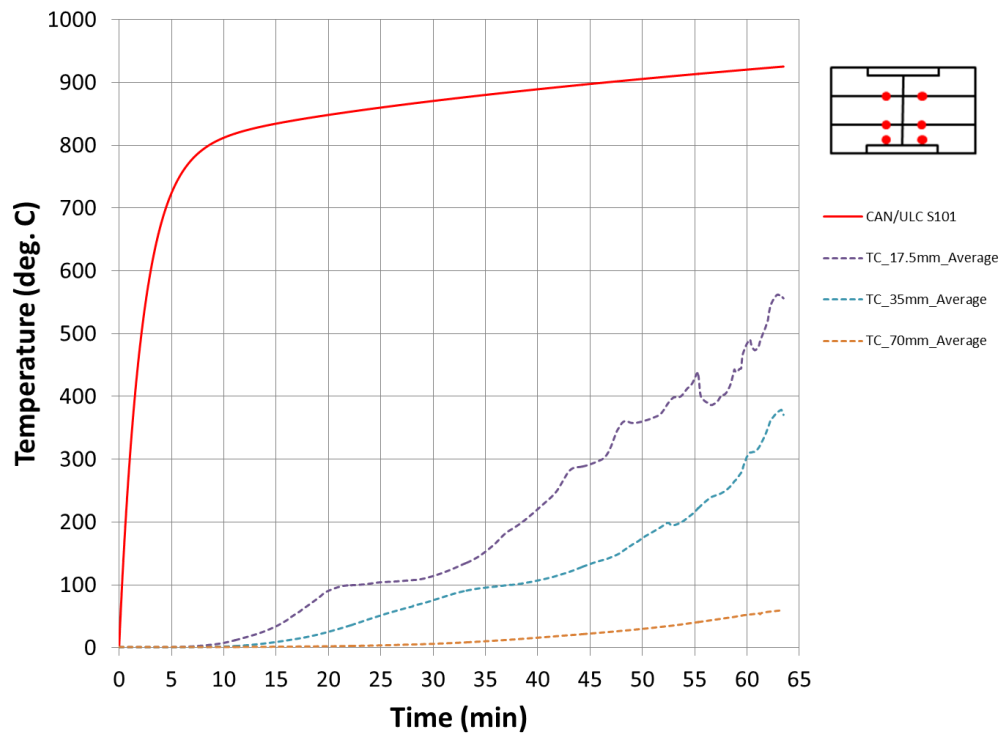

Figure 39. Temperature profiles for the 3-ply double surface spline (average values)

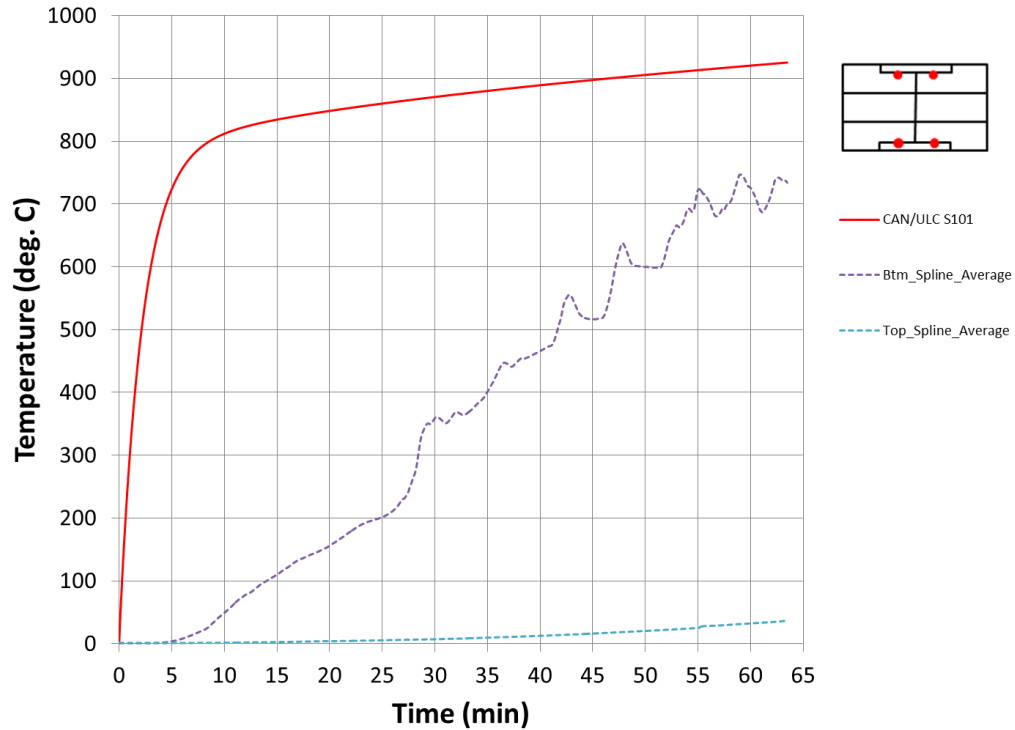

Figure 40. Temperature profiles at the surface splines of the 3-ply CLT (average values)

5.9 Double Surface Spline – 5 ply CLT

The 5-ply CLT with double surface splines was tested on February 11, 2015. The ambient conditions in the laboratory were -5°C and 30% relative humidity. The outdoor temperature was -14°C.

A load of 42 kN, representing a 55% loading condition determined from an initial 20 mm deflection, was applied (Figure 41). After 90 min, it was decided to end the test due to laboratory equipment safety concerns (several burn-through locations occurred along the sides and ends of the specimen). However, it was noted that a small burn-through occurred close to the surface spline (but within the CLT, not at the joint interface) at 82 min as shown in Figure 42. The actual reason for this burn-through is unclear as it occurred at a distance from the panel-to-panel joint and close to an end support.

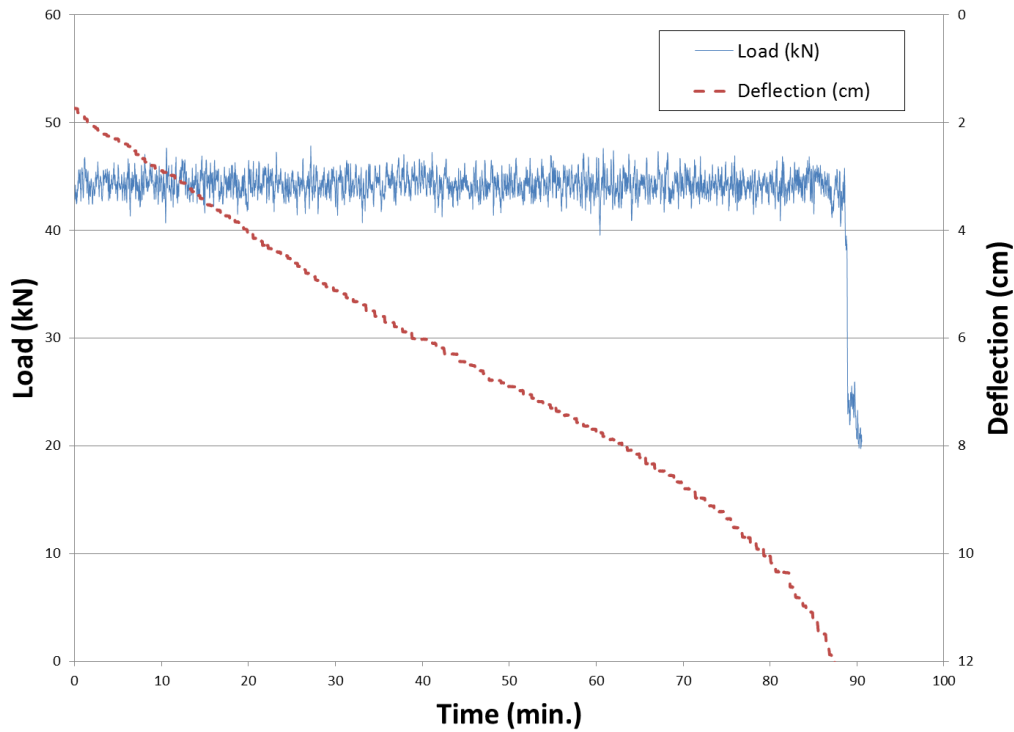

Figure 41. 5-ply double surface spline load and deflection measurements

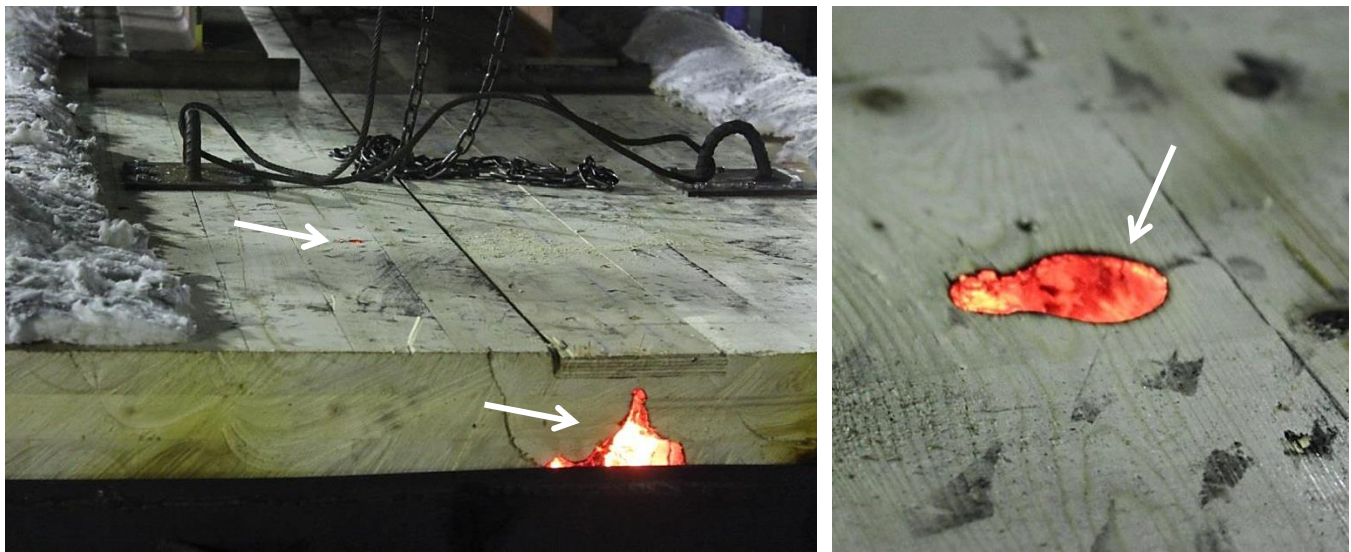

Figure 42. Failure of the 5-ply double surface spline

The furnace temperature, although lower for most of the test as shown in Figure 43, accurately followed the standard time-temperature curve. Figure 44 and Figure 45 show the temperature profiles recorded throughout the CLT and at the junction of the surface splines (top and bottom). The 300°C isotherm was reached at 17.5, 35 and 70 mm after 32, 43 and 89 min, yielding a charring rate of 0.55, 0.81 and 0.79 mm/min, respectively. No significant temperature rises were recorded at the 3rd glue line (105 mm)

and beyond (thus not shown in Figure 44 and Figure 45 beyond 105 mm). The top of the bottom spline reached 300°C at 25 min.

As mentioned previously, the reason for the failure time (82 min) is unclear since very little temperature rise was recorded at the 4th glueline (140 mm) (Figure 44) and none underneath the top surface spline (Figure 45).

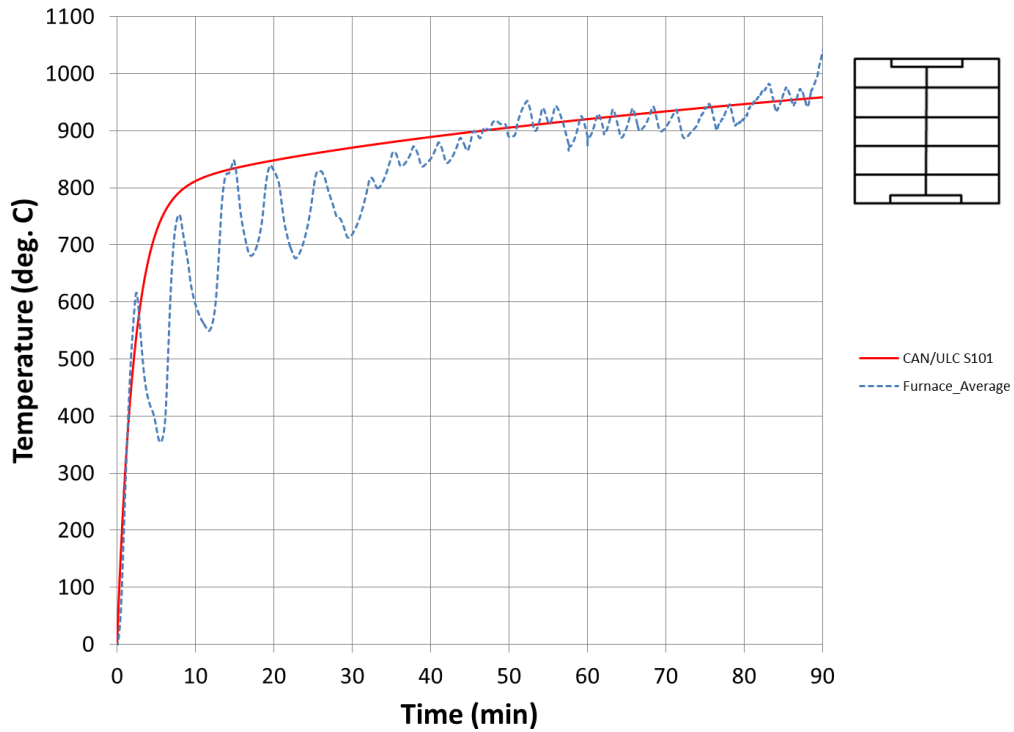

Figure 43. Furnace temperature curve for the 5-ply double surface spline (average values)

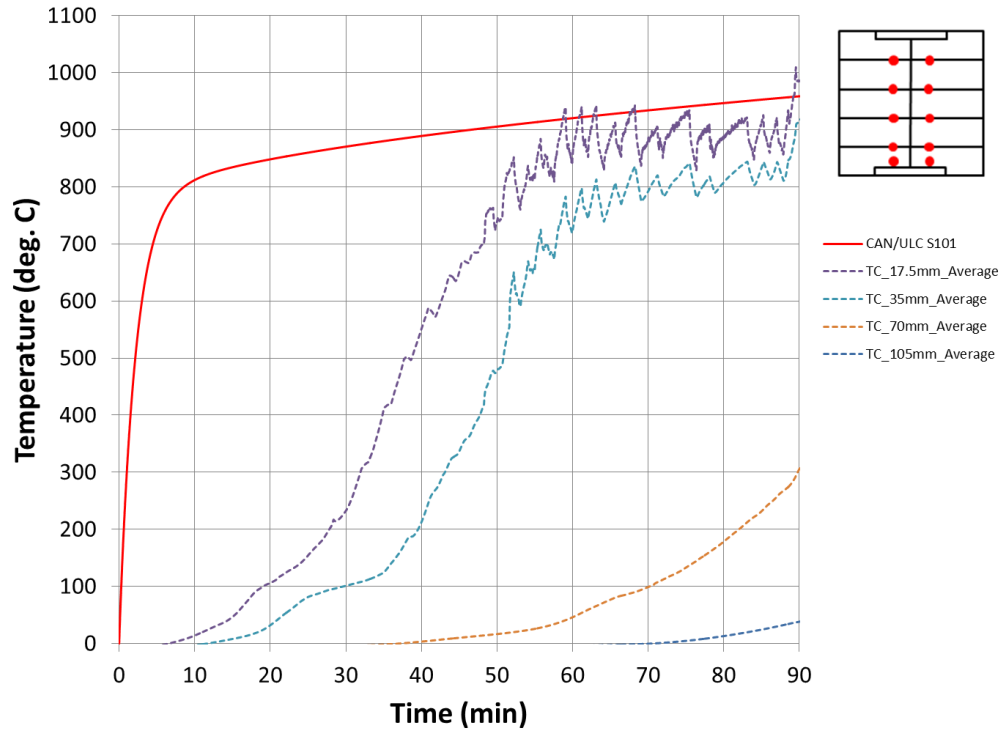

Figure 44. Temperature profiles for the 5-ply double surface spline (average values)

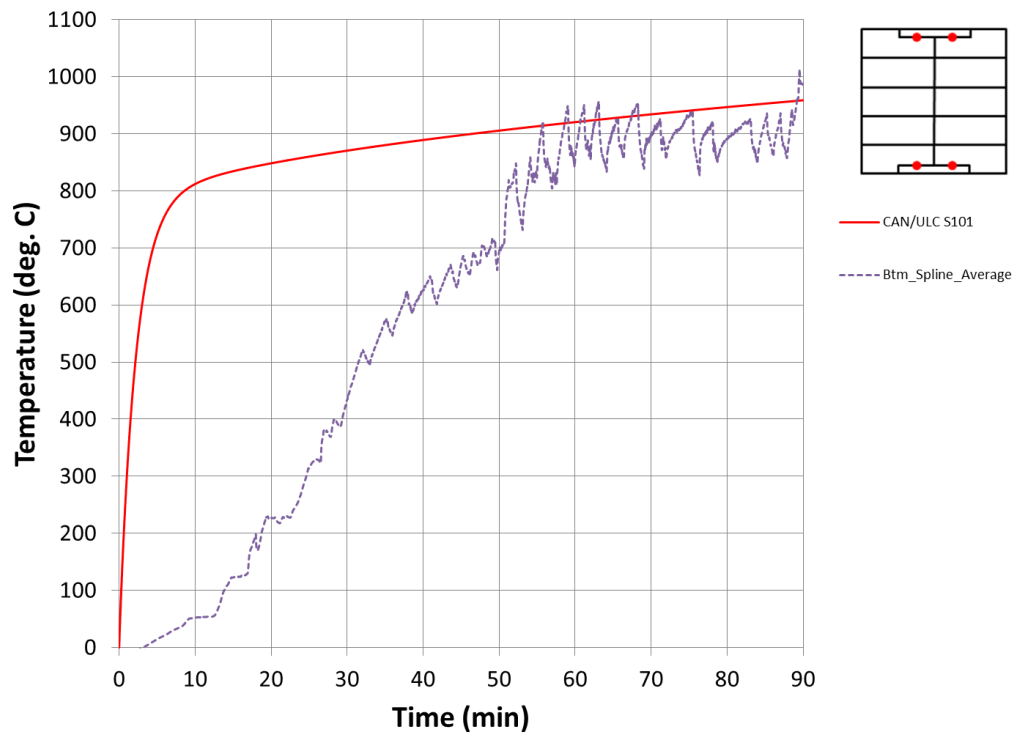

Figure 45. Temperature profiles at the surface splines of the 5-ply CLT (average values)

5.10 Double Surface Spline – 7 ply CLT

The 7-ply CLT with double surface splines was tested on February 27, 2015. The ambient conditions in the laboratory were -7°C and 27% relative humidity. The outdoor temperature was -16°C.

A load of 50 kN, representing a 37% loading condition limited by the load cell capacity, was applied (Figure 46). Shortly after 180 min into the test, a loud sound was heard due to a structural failure. As such, it was decided to end the test due to laboratory equipment safety concerns. Several burn-through locations occurred along the sides and ends of the specimen. However, no burn-through was observed at the unexposed surface or next to the panel-to-panel joint. No failure time was recorded.

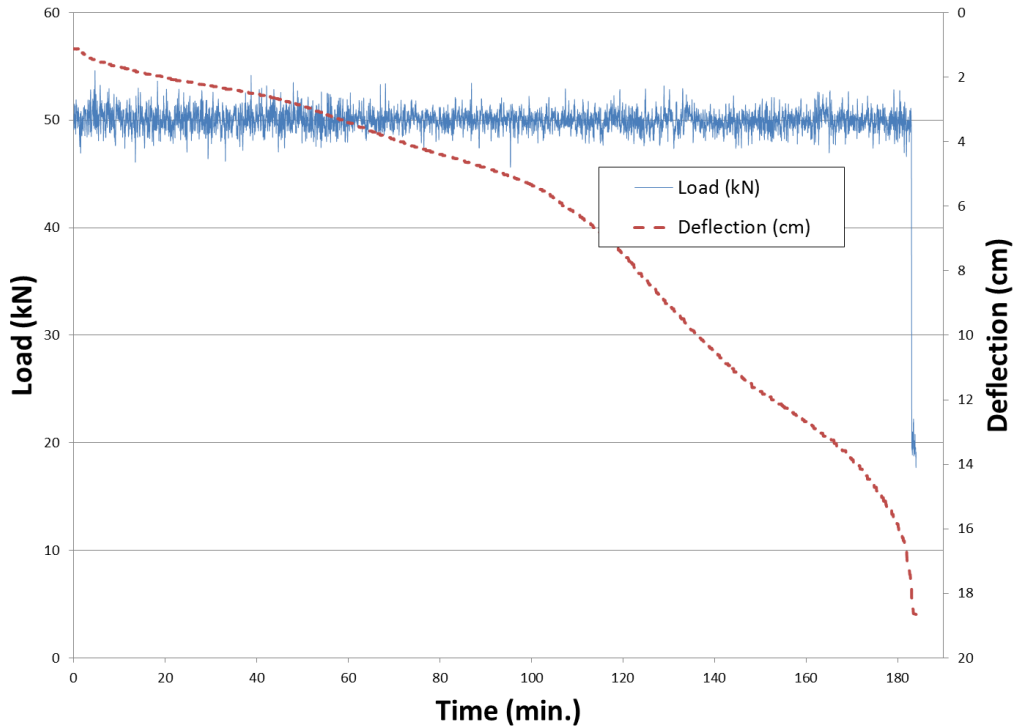

Figure 46. 7-ply double surface spline load and deflection measurements

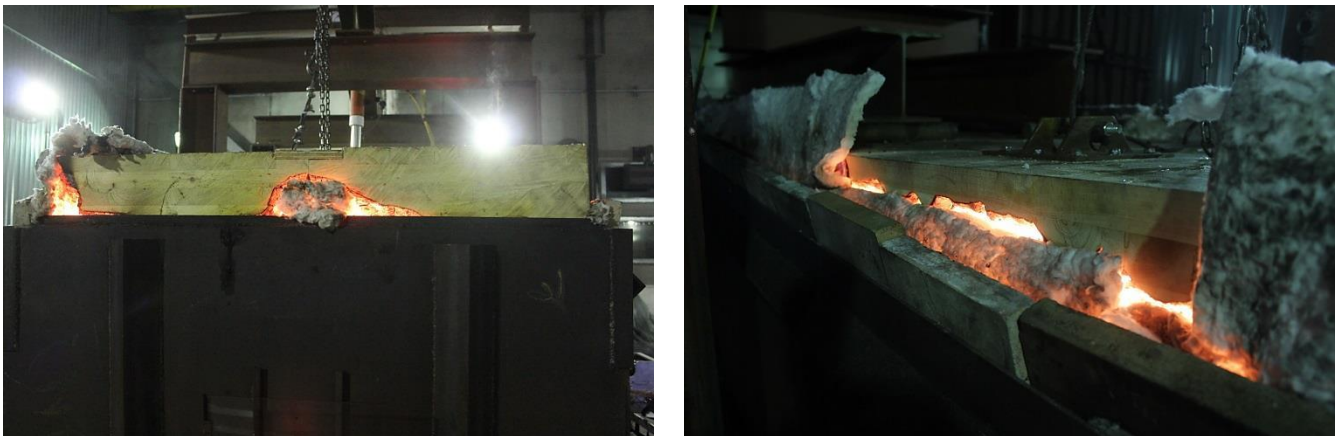

Figure 47. Burn-through along the perimeter of the 7-ply double surface spline

The furnace temperature, although being lower in the early stage of the test, followed well the standard time-temperature curve(Figure 48). Figure 49 and Figure 50 show the temperature profiles recorded throughout the CLT and at the junction of the surface splines (top and bottom). The 300°C isotherm was reached at 17.5, 35, 70 and 105 mm after 52, 51, 114 and 167 min, yielding to a charring rate of 0.34, 0.69, 0.61 and 0.63 mm/min, respectively. No significant temperature rises were recorded beyond the 3rd glue line (105 mm) and at the top surface spline (thus not shown in Figure 49 and Figure 50 beyond 140 mm). The top of the bottom spline reached 300°C at 46 min.

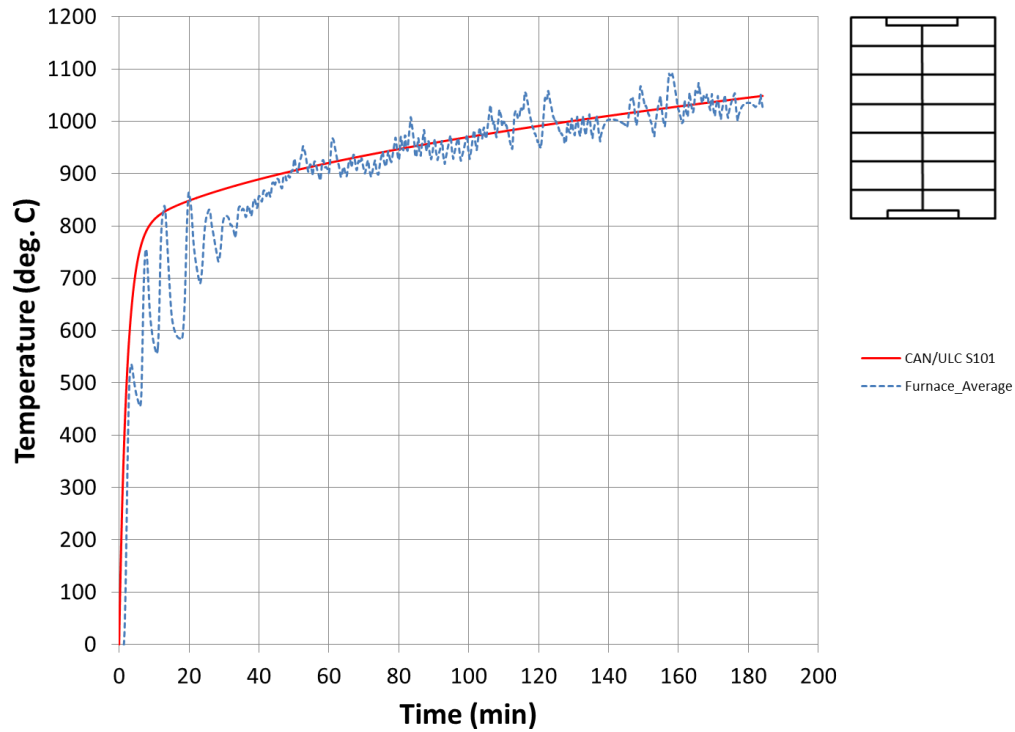

Figure 48. Furnace temperature curve for the 7-ply double surface spline (average values)

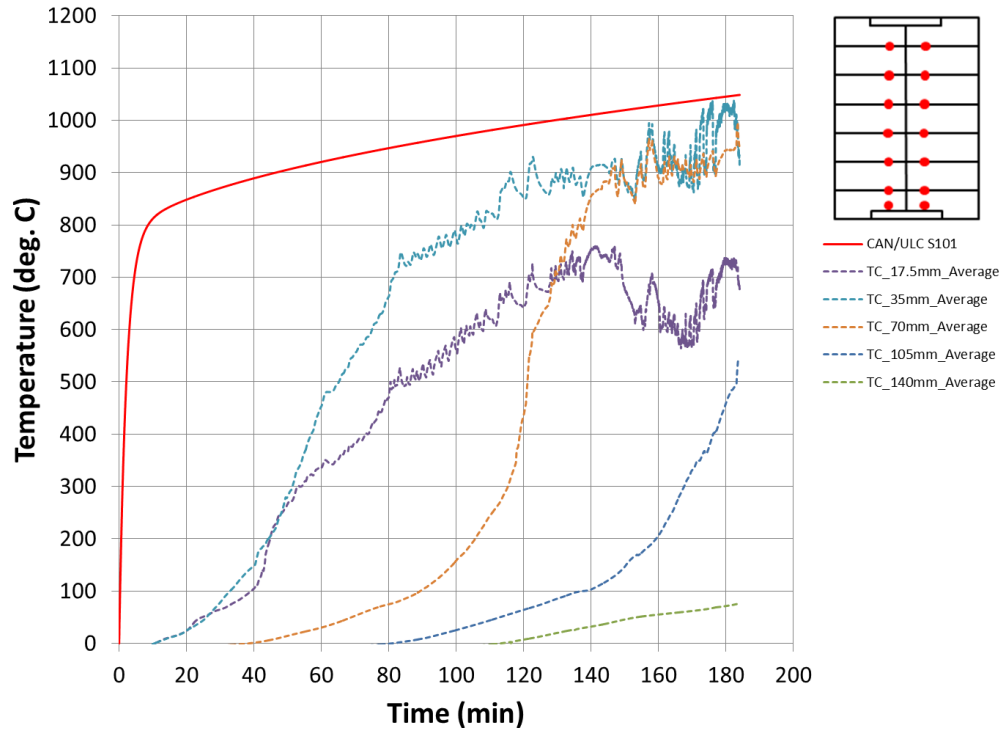

Figure 49. Temperature profiles for the 7-ply double surface spline (average values)

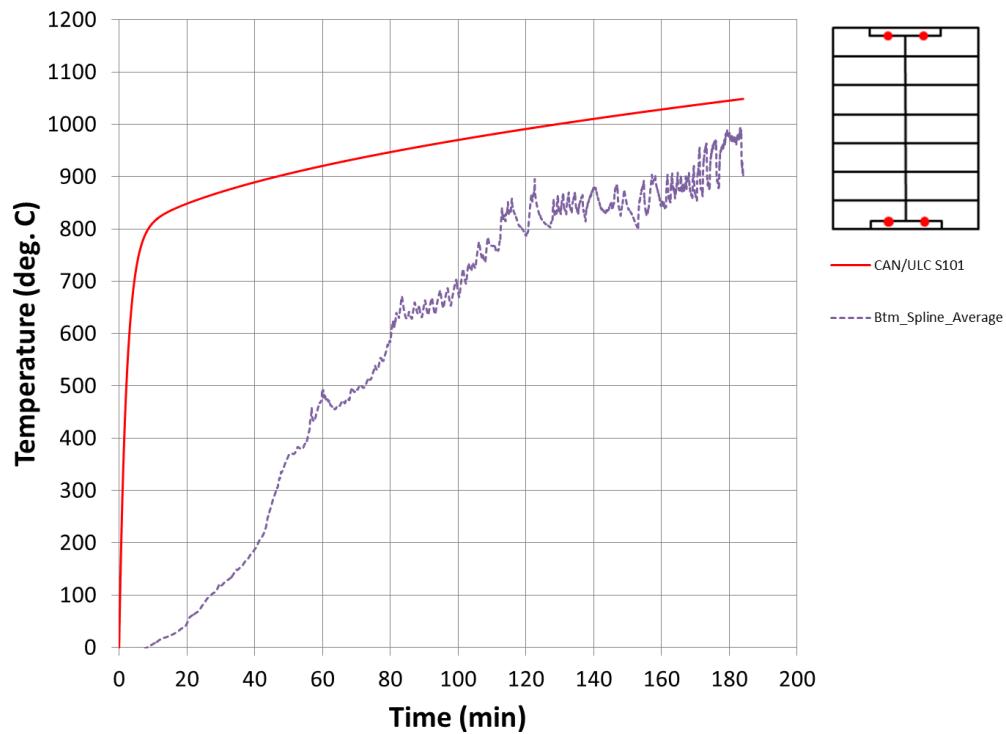

Figure 50. Temperature profiles at the surface splines of the 7-ply CLT (average values)

6 DISCUSSION

As suggested in section 2 of this report, a panel-to-panel joint profile should provide sufficient fire-resistance provided the loss in depth of the reduced cross-section has not yet reached the spline or the half-lapped joint. The following subsections provide a discussion on the actual integrity failure models, as given in Equation (1) and Eurocode 5:1-2 which are detailed in section 2 of this report. A proposal for developing joint coefficients for other types of CLT panel-to-panel joints is also presented.

6.1 Half-lapped Joint

According to Equation (1), an integrity failure of 56, 94 and 132 min would be predicted for a 3-ply, 5-ply and 7-ply CLT, respectively, manufactured with laminates of 35 mm. Eurocode 5:1-2 would predict failure times of 48, 81 and 113 min.

The test failure times observed in this series are 45, 98 and 140 min, which agree well with the predicted failure times and suggest that current models for predicting integrity failure are appropriate (provided the standard time-temperature is actually being closely followed, which was not the case for the 3-ply specimen).

6.2 Internal Spline

The test failure times observed in this series were 35 and 76 min for the 3-ply and 5-ply specimens respectively. These times were much faster than the predicted 64 and 107 min using Eurocode 5:1-2. Except for the 3-ply specimen, of which no furnace temperature data is available, the 5-ply exhibited reasonable charring rates when compared to those suggested in the 2014 Chapter 8 of the CLT Handbook. It is however unclear as to why the char front reached the spline quicker than at the 2nd glueline (70 mm). The spline is located at 78 mm from the exposed surface. According to Figure 27 and Figure 28, the char front reached the spline at 75 min while thermocouple readings at the 2nd glueline indicate a time of 85 min. Nevertheless, the burn-through failures obtained from both tests occurred where the spline was butt-jointed. A potential reason for such rapid burn-through may be due to the internal pressure within the furnace, forcing fresh air to flow into the CLT assemblies through relatively small gaps such as one that could be generated when butt-jointing plywood splines.

It can be demonstrated, by engineering analysis, that the European joint coefficient value of 0.4 is appropriate, even though the current two tests do not correlate (probably due to spline butt-joints not being tightly fitted). According to the stepped charring model detailed in the CLT Handbook, a laminate of 35 mm thick would be expected to initiate fall-off after 43 min of standard fire exposure (which is consistent with rates observed from the 5-ply specimen where the char front reached the 2nd glueline at 85 min). Given the joint configuration, 8 mm of the CLT is provided underneath the plywood spline, which would char within 8 min. Eurocode 5:1-2 assigns a charring rate of 1.0 mm/min for plywood of 20 mm with a characteristic density of 450 kg/m³. It is thereby assumed that an 18.5 mm plywood spline would char within 18 min. Assuming that there are no air gaps between the splines, the sum of the time afforded by each layer would yield a failure time of 69 and 112 min for a 3-ply and 5-ply CLT, respectively.

Equation (1) used with a joint coefficient of 0.4 would yield in similar predictions (64 and 107 min).

6.3 Single Surface Spline

As reported in subsections 5.6 and 5.7, no failure times were recorded for CLT specimens joined together with a single surface spline. There is also no joint coefficient assigned to this configuration in the publicly-available literature.

The 3-ply CLT specimen was allowed to burn for 54 min, at which time the char front had reached the 1st glueline (35 mm). The temperatures at the 2nd glueline (70 mm) and at the interface underneath the surface spline were 58°C and 25°C respectively at this time. Using the engineering approach detailed in subsection 6.2, the stepped charring model would predict a time of 102 min for the char front to reach the spline interface (2 layers of 35 mm and a remaining 16 mm in the 3rd ply).

The 5-ply CLT specimen was allowed to burn for 98 min. At that time, the temperature recorded at the 2nd glueline (70 mm) was 78°C. No temperature rise was recorded at the joint interface underneath the top spline. These very low temperature measurements suggest that the specimen could have lasted much longer. Using the same engineering approach detailed in subsection 6.2, the stepped charring model would predict a time of 188 min for the char front to reach the spline interface (4 layers of 35 mm and a remaining 16 mm in the 5th ply).

Equation (1) used with a joint coefficient of 0.6 would yield in similar predictions (97 and 161 min). It is noted that Eurocode 5:1-2 assigns a joint coefficient of 0.6 to double tongue-&-groove spline between 2 adjacent wood-based panels.

6.4 Double Surface Spline

The test failure times observed in this series were 43, 82 and more than 180 for the 3-ply, 5-ply and 7-ply CLT specimens respectively. There is also no joint coefficient assigned to this configuration in the publicly-available literature.

The 3-ply CLT specimen was allowed to burn for 43 min. At that time, the char front reached the 1st glueline (35 mm); the temperature at the 2nd glueline (70 mm) and at the interface underneath the top spline were 59°C and 36°C respectively. These very low temperature measurements suggest that the specimen could have lasted much longer. Using the engineering approach detailed in subsection 6.2, the stepped charring model would predict a time of 93 min for the char front to reach the spline interface (plywood spline, 2 remaining 16 mm for the 1st and 3rd plies and 35 mm for the middle ply).

The 5-ply CLT specimen was allowed to burn for 90 min. At that time, the char front reached the 2nd glueline (70 mm) and the temperature at the 3rd glueline (105 mm) was 4°C. No temperature rise was recorded at the joint interface underneath the top spline. These very low temperature measurements suggest that the specimen could have lasted much longer. Using the engineering approach detailed in subsection 6.2, the stepped charring model would predict a time of 179 min for the char front to reach the spline interface (plywood spline, 2 remaining 16 mm for the 1st and 5th plies and 3 layers of 35 mm for the 2nd to 4th plies).

The 7-ply CLT specimen was allowed to burn for more than 180 min. At 180 min, the char front reached the 3rd glueline (105 mm) and the temperature at the 4th glueline (140 mm) was 76°C. No temperature rise was recorded at the joint interface underneath the top spline. These very low temperature

measurements suggest that the specimen could have lasted much longer. Using the engineering approach detailed in subsection 6.2, the stepped charring model would predict a time of 265 min for the char front to reach the spline interface (plywood spline, 2 remaining 16 mm for the 1st and 7th plies and 5 layers of 35 mm for the 2nd to 6th plies).

It is suggested that a similar joint coefficient to the single surface spline be used ($K_j = 0.6$) for the double surface spline configuration. As such, Equation (1) used with a joint coefficient of 0.6 would yield predictions of 97, 161 min and 226 min for 3-ply, 5-ply and 7-ply CLT of 35 mm laminates, respectively. The advantage from using a double surface spline as opposed to the single surface spline would be an improved in-plane shear resistance of CLT floor diaphragm or shearwall assemblies.

7 CONCLUSION AND RECOMMENDATIONS

During full-scale fire testing of CLT assemblies, it has been shown that integrity seems to be the predominant failure mode of CLT floor assemblies under load (i.e. flaming through the CLT panel-to-panel half-lapped joint). This type of failure mode was not observed in CLT wall test assemblies under load. Integrity is one of the two requirements of the separating function of building assemblies (insulation being the other requirement). The time at which the CLT panel-to-panel joint can no longer prevent the passage of flame or gases hot enough to ignite a cotton pad defines its integrity fire resistance.

So far, only half-lapped joints have been evaluated in full-scale fire tests where the joint was located at mid-depth of the CLT panels and overlapped for at least 64 mm. However, connection details of CLT assemblies may also consist of other configurations such as single or double surface splines or internal spline(s). These tightly fitted joint profiles should provide sufficient fire-resistance provided the loss in depth of the reduced cross-section has not yet reached the spline. It was the objective of this study to evaluate the fire performance of these joint details and to provide recommendations to develop a joint coefficient (K_j) for use in a simple equation such as that provided in the 2014 Chapter 8 of the Canadian CLT Handbook.

A total of ten CLT specimens were tested using different panel-to-panel joint details. The testing took place at Carleton University Fire Research Facilities. The CLT specimens were of the E1 stress grade conforming to ANSI/APA PRG-320 standard and were fastened together using self-tapping screws. Except for the half-lapped joint configuration, all other panel-to-panel joints required the use of plywood splines to securely fasten the CLT panels together. All joint assemblies were sealed using a bead of intumescent firestop sealant to prevent smoke leakage.

Eight failure times were recorded and compared to predictions using analytical models such as the CLT Handbook and Eurocode 5:1-2. From the failure times, it can be shown that current models accurately predict the integrity failure. Based on engineering analysis and the stepped charring model of the CLT Handbook, joint coefficients for the single and double surface spline configurations have been developed.

Based on the test data, joint coefficients of 0.35 for a half-lapped joint located at mid-depth, 0.40 for a plywood internal spline at mid-depth and 0.60 for the single and double surface splines are recommended. It is noted that a more in-depth analysis could involve specifying a minimum thickness

that would enable fasteners to continue developing withdrawal and/or lateral resistance. This would yield potentially lower joint coefficient values. Modeling the behaviour of these joints using a transient finite element thermal model could also be useful to support the engineering approach based on the stepped charring model. Further testing of CLT panel-to-panel joints is required.

Lastly, the effect of floor covering and/or topping has not been evaluated in this study. It is anticipated that using floor covering materials such as a concrete topping would limit the passage of flames and hot gases and the joint coefficient may be taken as unity, as suggested in Eurocode 5:1-2.

8 REFERENCES

- [1] ULC, CAN/ULC S101 - Standard Method of Fire Endurance Tests of Building Construction Materials, Toronto (Ont.): Underwriters Laboratories of Canada, 2007.
- [2] C. Dagenais, CLT Handbook (CDN Edition): Chapter 8 - Fire Performance of Cross-Laminated Timber Elements, FPIInnovations, 2014.
- [3] CSA, CSA O86-14: Engineering Design in Wood, Mississauga (Ont.): CSA Standards, 2014.
- [4] L. Osborne, C. Dagenais et N. Bénichou, «Preliminary CLT Fire Resistance Testing Report (Project No. 301006155) - Final Report 2012/13,» FPIInnovations, 2012.
- [5] CEN, Eurocode 5 : Design of timber structures - Part 1-2 : General - Structural fire design, Brussels, Belgium: European Committee for Standardization, 2004.
- [6] J. W. O'Neil, The Fire Performance of Timber Floors in Multi-Storey Buildings (Thesis), Christchurch (NZ): University of Canterbury, 2013.
- [7] M. L. Janssens et R. H. White, «Short Communication: Temperature Profiles in Wood Members Exposed to Fire,» *Fire & Materials*, vol. 18, pp. 263-265, 1994.
- [8] ANSI, «Standard for Performance-Rated Cross-Laminated Timber (ANSI/APA PRG 320-2012),» APA - The Engineered Wood Association., Tacoma, Wa., 2012.
- [9] APA, «Product Report PR-L306C - Nordic X-Lam,» APA - The Engineered Wood Association, Tacoma (WA), 2012.
- [10] CCMC, «Evaluation Report CCMC 13677-R SWG Assy VG Plus and SWG ASSY 3.0 Self-Tapping Wood Screws,» Canadian Construction Materials Centre, Ottawa (Ont.), 2013.
- [11] Hilti, Product Data Sheet for FS-ONE Intumescent Firestop Sealant, Mississauga (Ont.): Hilti Canada Corp., 2015.



Head Office

Pointe-Claire

570 Saint-Jean Blvd
Pointe-Claire, QC
Canada H9R 3J9
T 514 630-4100

Vancouver

2665 East Mall
Vancouver, BC
Canada V6T 1Z4
T 604 224-3221

Québec

319 Franquet
Québec, QC
Canada G1P 4R4
T 418 659-2647



OUR NAME IS INNOVATION