

Fire Safety Design in Buildings

*A reference for applying the
National Building Code of
Canada fire safety requirements
in building design*

Canadian
Wood
Council

Conseil
canadien
du bois



1996 Copyright
Canadian Wood Council
Conseil canadien du bois
Ottawa, Ontario Canada

ISBN 0-921628-43-9

Printed in Canada

2.5M796, 2.5M91

Photograph Credits

Beinhaker/Irwin Associates 226
Byrne Architects 2
Graham F. Crockart Architect 133
CWC 5, 31, 43, 57, 78, 80, 130, 201, 215, 217, 229, 305, 313, 314, 320, 323, 326
Dalla-Lana/Griffin Architects 192
Ivan G. Dickinson, Architect 73
Fire in America 3, 9, 11
Harold Funk Architect 294
Gauthier, Guité, Daoust, Lestage Architectes 28, 32
Griffiths, Rankin, Cook Architects 270
Hemingway, Nelson Architects 266
Henriquez Partners 70
The Hulbert Group 50, 198
IBI Group Architects 283
NRCC 15
Ottawa Citizen 63, 302
Allan Rae Architect 144, 181
F.J. Reinders & Associates 221
Tolchinsky and Goodz Architect 61
Lubor Trubka Architect 193

Foreword

The Canadian Wood Council (CWC) is the national federation of forest product associations. CWC is responsible for the development and distribution of technical information including codes and standards, and fire safety design for buildings.

Fire Safety Design in Buildings is one of the CWC publications* developed to assist designers. It is intended to help designers apply the fire safety requirements of the *National Building Code of Canada* for all buildings. This is a companion, explanatory document to the *NBCC*.

Fire Safety Design in Buildings compliments the *Wood Design Manual, Wood Reference Handbook* and other CWC publications. Together they provide a comprehensive family of reference material for professionals involved with building design.

The Canadian wood industry devotes considerable resources for fire research programs to improve the understanding of the performance of wood products in fire. This fire research will be used to support a Canadian approach to a world-wide trend toward building codes based on performance instead of prescriptive requirements.

The Board of Directors, members, and staff of the Canadian Wood Council trust this book will assist you in designing with wood - the renewable resource.

Kelly McCloskey
President

*For more information on CWC design tools call this toll free number: 1-800-463-5091

The Environmental Benefits of Building with Wood

In a recent survey of building specifiers, the majority perceived wood to be the most environmentally friendly building material. Compared to other major building materials, this is due mainly to:

- the renewability of wood
- the low energy consumption required for production
- the low levels of pollutant emission during manufacture

Lately, environmental considerations have acquired more importance in the specification of materials. Technical and economic aspects of building materials have always been primary considerations for specifiers. Increasingly, however, they are considering the environmental effects when selecting appropriate building materials for their designs.

Architects, engineers and designers require accurate information to assess the true environmental consequences of the materials they specify.

The environmental impacts of various building materials have been examined by a Canadian Research Alliance using the internationally accepted method called Life-Cycle Analysis (LCA). The Alliance consists of researchers from the wood, steel and concrete industries as well as university groups and consultants.

Life-cycle analysis evaluates the direct and indirect environmental effects associated with a product,

process or activity. It quantifies energy and material usage and environmental releases at each stage of a product's life cycle including:

- resource extraction
- manufacturing
- construction
- service
- post-use disposal

One product of this three year life-cycle project is a computer model, Athena™, that facilitates comparative evaluation of the environmental effect of building assemblies.

In addition to those familiar qualities that have made wood such a dominant material in North America, the Life-Cycle Analysis methodology confirms wood products to be a wise choice for designers from an environmental standpoint.

The reasons for this are explained in the following information:

RESOURCE EXTRACTION:

The environmental effects of resource extraction are the most difficult to quantify because of the variability of extraction methods and the variability in the ecology of different sites.

The study made the following observations:

- There are three dimensions to the extraction process: extensiveness, intensiveness, and duration.

- All extraction creates significant ecological impacts.
- Mining extractions are more intensive and endure longer than forest extractions.
- Forest extractions are more extensive in terms of land area affected.

Of all the phases of the life-cycle, extraction is the most subjective. The ecological impacts of forest cutting can differ by several orders of magnitude from best practice to worst practice.

Similarly, the differences between the worst practices and the best practices of each extractive industry may well be greater than the differences between those industries. This does not offer a definitive conclusion, but highlights the importance of Canada's leadership in practising sustainable forestry.

MANUFACTURING:

During the manufacturing stage, raw resources are converted into usable products. The manufacturing stage is the most easily quantifiable stage as all the processes are under human control, and the stage where the environmental advantage of using wood is most apparent.

Wood requires much less energy to manufacture and causes much less air and water pollution than steel or concrete.

The Athena™ model was used to compare the environmental

effects of a non-loadbearing steel-stud wall to a wood-stud wall. Compared to the wood-stud wall, the steel-stud wall:

- used three times more energy
- produced three times more CO₂
- used twenty five times more water
- had a much greater impact on the quality of the water and air

The wood wall, by requiring much less energy to manufacture reduces the use of fossil fuels. Fossil fuels are non-renewable and their use is linked to global warming, thinning of the ozone layer and acid rain.

CONSTRUCTION:

The construction stage includes on-site construction as well as transportation of the materials from local plants or suppliers.

The major impacts at the construction stage are caused by the energy used for transportation and construction equipment and the solid waste generated during construction. Comparison of building materials in this life-cycle phase showed no major differences in energy use.

However, the study did determine the wood-framed wall generated one third more waste on the jobsite than the steel-framed wall. The quantity of solid waste generated from wood framing depends greatly on the construction system used and builder's attention to material use.

Changing economics are reducing construction waste from wood frame construction and redirecting it to other uses than landfill.

SERVICE:

The service phase of the life-cycle is the period when the material performs its function as part of the structure.

Framing materials do not present environmental impacts when they are in service since they consume neither energy nor resources. However, the choice of building materials can significantly affect the energy requirements for heating and cooling.

When compared with steel, wood is a much better thermal insulator. Thus, wood-frame structures consume far less energy for heating and cooling than steel-frame structures for the same quantity of insulation. For more information on the insulating properties of wood and steel frame construction, please consult the Canadian Wood Council publication, *The Thermal Performance of Light-Frame Assemblies*.

POST-USE DISPOSAL:

The last stage of the life-cycle, post-use disposal, is difficult to assess because it takes place far in the future - at the end of the useful life of the product.

Steel is better established as a recyclable material with facilities in place. The wood recycling

industry in Canada is still in its infancy but is expanding rapidly. Several large centres in Canada have wood recycling facilities that use wood scrap to produce horticultural mulch or wood chips for hardboard.

Recycling is a return to the manufacturing stage, and as wood recycling increases, the environmental advantage of wood during this stage will be apparent. Where wood recycling facilities are not available, wood products are biodegradable and return to the earth and ultimately are renewed through new growth.

CONCLUSION:

In spite of scientific analyses that demonstrate many environmental advantages for wood building materials, the public still has concerns about wood. This is due in part to the highly visible effects of wood resource extraction.

To address these concerns, the Canadian Forest Industry, in addition to adopting enhanced forest management techniques, is actively supporting the development of Sustainable Forestry Certification Standards by the Canadian Standards Association (CSA). Certification assures consumers that the products they buy are made from wood that comes from an environmentally sound and sustainable forestry operation.





The preceding information forms the basis for responsible choices by specifiers - choices which are not always easy or straightforward. Some products are simply better suited for particular applications.





Specifying a product that comes from a renewable resource, that is energy conservative in

manufacture and use, and that can be easily recycled or reused, minimises the environmental impact and makes sustainable development an achievable goal.

Wood is an extraordinary material that offers these environmental advantages.

Table of Contents

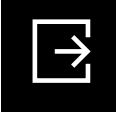
Building Regulations in Canada	1.1	The National Building Code of Canada	3	1 
	1.2	Fires that Shaped the Code	9	
	1.3	Development of the NBCC	17	
	1.4	CCBFC Strategic Plan and Objective Based Codes	23	
		Chapter Summary	26	
Building with Wood	2.1	General Information	29	2 
	2.2	Structural Systems in Wood	31	
	2.3	Wood in Noncombustible Buildings	39	
		Chapter Summary	48	
The NBCC: Assumptions and Objectives	3.1	General Information	51	3 
	3.2	The NFPA Fire Safety Concepts Tree	53	
	3.3	Limiting Fire Growth	55	
	3.4	Containing the Fire	61	
	3.5	Suppress the Fire	65	
	3.6	Managing the Exposed	67	
		Chapter Summary	68	
Construction Requirements	4.1	General Information	71	4 
	4.2	Classification of Buildings	73	
	4.3	Determining Construction Requirements	83	
	4.4	Sprinkler Protection	91	
	4.5	Storeys Below Ground	95	
		Chapter Summary	96	
		Design Requirements Tables	97-127	
Structural Fire Protection	5.1	General Information	131	5 
	5.2	Fire Separations	133	
	5.3	Fire-Resistance Ratings	147	
	5.4	Alternative Methods for Determining Fire-Resistance Ratings	157	
	5.5	Fire-Resistance Rating Requirements in the NBCC	175	
	5.6	Fire Protection Requirements for Mezzanines and Atriums	185	
	5.7	Fire Stops	189	
	5.8	Sprinkler Alternatives	193	
		Chapter Summary	195	

Flame Spread of Materials	6.1	General Information	199	6 
	6.2	Determining Flammability	201	
	6.3	Interior Finishes	207	
	6.4	Fire-Retardant Treated Wood	213	
	6.5	Roof Assemblies	217	
		Chapter Summary	223	
Fire Spread Between Buildings	7.1	General Information	227	7 
	7.2	Objectives and Assumptions	229	
	7.3	Limiting Distance	233	
	7.4	Exceptions to Spatial Requirements	243	
	7.5	Exposure Protection Within a Building	245	
	7.6	Examples of Spatial Separation Calculations	251	
		Chapter Summary	264	
Fire Safety within Floor Areas	8.1	General Information	267	8 
	8.2	Occupant Load	269	
	8.3	Fire Alarm and Detection Systems	273	
	8.4	Means of Egress	281	
	8.5	Safety within Floor Areas of Specific Occupancies	293	
	8.6	Service Spaces	297	
		Chapter Summary	299	
Provisions for Firefighting	9.1	General Information	303	9 
	9.2	Access to Buildings	305	
	9.3	Fire Protection Systems	311	
		Chapter Summary	317	
High Buildings	10.1	General Information	321	10 
	10.3	Fire Safety in High Buildings	323	
		Chapter Summary	328	
Appendix		Information Sources	331	
		Index of Tables and Figures	337	
		Bibliography	341	
		Index	345	
		Index of Code References	355	



Building Regulations in Canada

1.1	The National Building Code of Canada	3
	The Origin of Building Codes	3
	The Modern NBCC	5
	Division of Building Research	6
	National Fire Protection Association	6
	The NBCC and This Document	7
1.2	Fires that Shaped the Code	9
	Cocoanut Grove Nightclub	10
	Laurier Palace Theatre	10
	Catastrophic Hotel Fires	12
	High Rise Fires	13
	Lessons Learned	14
1.3	Development of the NBCC	17
	Standing Committees of the CCBFC	18
	Canadian Codes Centre	18
	Code Change Cycles and Public Input	19
	Relationship between the NBCC and the NFCC	20
1.4	CCBFC Strategic Plan and Objective Based Codes	23
	Chapter Summary	26



1.1 The National Building Code of Canada

The *National Building Code of Canada (NBCC)* is widely acclaimed, not only in Canada, but also in other countries. This is because it is a consensus-based structure for producing a model set of requirements which provide for the health and safety of the public in buildings.

By historical standards, the *NBCC* is fairly young but, like its many counterparts around the industrialized world, it draws on the experience of several centuries of tragic incidents and attempts by legislators to provide safeguards against the ever-present threat of fire.

THE ORIGIN OF BUILDING CODES

Building construction regulations are not a new phenomenon. The earliest recorded legislation governing building construction is attributed to Hammurabi, King of Babylon, around 1700 BC.

His decree placed the responsibility for the structural sufficiency of a

building on the builder, based on the principle of “an eye for an eye.” A builder would be executed if the house he built collapsed and caused the death of the owner. In addition, early Roman laws show that legislators sought to prohibit construction of dense clusters of multi-storey wood structures that made it impossible to confine the effects of fire to a single property.

Throughout history, fire has been the most common form of disaster to human settlements. Though incendiary acts during wartime probably accounted for the greatest devastation, sources of fire for cooking, lighting and heating constituted a constant hazard. In times past, these have destroyed entire villages and towns.

Hence, early building ordinances were almost always developed to control sources of fire, and frequently included fines as a deterrent against carelessness. But the gravest threat remained arson. Throughout the 17th, 18th

FIGURE 1.1

The Boston Fire in 1872 was one of several major city fires that identified the need for new fire regulations

Canadian building regulations provide for extensive wood structures



and 19th centuries, arson was a scourge that defied every ounce of vigilance. Eventually, it became clear that the construction and location of buildings needed to be addressed.

Conflagrations such as the Great Fire of London in 1666, which destroyed some 13,000 properties, led to the introduction of the London Building Act. This is considered the first comprehensive building code.

This law, written under the guidance of Sir Christopher Wren, defined four classes of buildings and specified how and where they were to be built. Critical aspects included:

- prohibition of thatched roofs and timber chimneys
- specific requirements for wall construction
- limits on building heights

The Great Fire of London also heralded the establishment of fire insurance companies which would often become catalysts in the production of standards for fire safety in buildings.

In the United States, building construction regulations date back to the 17th century. In Boston, laws were passed that prohibited thatched roofs and wooden chimneys and required stone or brick walls on buildings after two fires destroyed major parts of the city in 1631 and 1679.

Throughout the 17th and 18th centuries, many other communities enacted similar ordinances in the aftermath of major fires.

Although these laws contained specifications on building construction, most requirements still concerned ways to limit the spread of fire and the availability of firefighting means. These types of requirements form today's fire prevention codes such as the *National Fire Code of Canada (NFCC)*, discussed later in this chapter.

The promulgation of modern building codes essentially began in the US and Canada at the turn of the century after some major conflagrations.

Quebec City (1866), Chicago (1871), Boston (1872), Saint John (1877), Ottawa-Hull (1900), Baltimore (1904), Toronto (1904) and San Francisco (1906) all suffered disastrous fires which left many thousands homeless. These fires served as lessons which led to the introduction of regulations governing:

- distances between buildings
- limitations on building height
- the use of combustible materials such as cladding on buildings

There were also tragic incidents involving single buildings such as the Iroquois Theatre fire in Chicago in 1903, where 602 died, and a number of other fires in hospitals and schools that resulted in extensive loss of life.

In Canada and the US, municipal by-laws spread across the country. Even though the regulation of building construction is a provincial responsibility under the constitution of Canada, provinces usually delegated this authority to municipalities prior to the 1970s.

FIGURE 1.2

National Building Code of Canada, 1941, 1953, 1995



In the 1930s, there were probably as many different building codes in Canada as there were municipalities with sufficient construction activity to warrant some form of regulation. All of these varied greatly in technical content and sophistication.

Because of the lack of engineering data upon which fire protection could be based, some codes required excessive fire protection at great cost while others did not adequately address the fire risk. This created a very confusing situation for designers, builders and manufacturers.

In 1918, J. Grove Smith fully explored the Canadian situation in a report of the Commission of Conservation, *Fire Waste in Canada*. He advocated the development of uniform standards for building construction and fire control. The report emphasized to the regulating authorities the need for better controls in building construction and contributed

to Smith's appointment as the first Dominion Fire Commissioner. It also influenced those responsible for the creation of Canada's first model building code.

THE MODERN NBCC

The *National Housing Act (NHA)* was originally created to promote the construction of new houses, the repair and modernization of existing homes and the improvement of housing and living conditions.

When it was introduced in the 1930s, it was recognized that its implementation would be greatly facilitated by the adoption of uniform house construction standards throughout the country. It also became apparent that other types of building construction would benefit from a uniform set of construction requirements.

As a result, the Department of Finance, then responsible for application of the NHA, enlisted



the help of the National Research Council of Canada (NRC) to develop a set of model regulations which could be adopted by any enabling jurisdiction in Canada. Jointly, they produced the first edition of the *NBCC*, released in 1941.

DIVISION OF BUILDING RESEARCH

Subsequent to this first effort, it was acknowledged that a building code must be updated to respond to economic and technological changes in the field of construction. Furthermore, as buildings were growing in size and height through advances in structural design, new materials and heating and ventilating equipment, a number of questions arose regarding:

- the spread of fire within and between buildings
- structural sufficiency under fire exposure
- structural sufficiency under severe loads such as earthquakes
- human behaviour during emergencies

These considerations and a call by provincial fire enforcement authorities for more research pertinent to the Canadian context led the NRC to create, in 1947, the Division of Building Research (DBR). This was a research and technology information service for the Canadian industry which is now known as the Institute for Research in Construction (IRC).

The DBR was also responsible for providing technical and secretarial support to the Associate Committee on the National Building Code

(ACNBC), established in 1948 to oversee the development of the *NBCC*. In 1991, the ACNBC and the Associate Committee of the National Fire Code were replaced by a single committee, the Canadian Commission on Building and Fire Codes (CCBFC).

The CCBFC is one of many committees the NRC uses to bring together specialists from across the country to guide its activities so that it may better respond to national concerns.

By the 1970s, responsibility for the application of building regulations had shifted from local to provincial governments. The Provincial Advisory Committee, composed of representatives from the provincial building standards departments, was formed to ensure that provincial concerns were taken into account in the development of the *National Building Code of Canada*.

In 1990, this committee was replaced by the Provincial/Territorial Committee on Building Standards (PTCBS) which brought together higher level representatives to ensure an even greater provincial commitment to the national model code.

NATIONAL FIRE PROTECTION ASSOCIATION

The first edition of the *NBCC* was, for the most part uniquely Canadian, with account taken of US experiences. The subsequent elaboration of the *NBCC* was more strongly influenced by fires in the

US, particularly through the participation of Canadian fire officials in the work of the National Fire Protection Association (NFPA).

This organization, based in the United States, plays an important role in the development of codes and standards through the investigation, analysis and reporting of findings from fires, as well as the publishing of standards.

Canada's participation in NFPA dates back to 1912 when a Canadian Committee of the association was formed. A recent joint investigation by NFPA and NRC into the fire at the Forest Laneway Apartments in North York, Ontario demonstrates that co-operation between US and Canadian fire authorities is still strong. (Figure 1.6)

THE NBCC AND THIS DOCUMENT

The *National Building Code of Canada* contains 9 Parts. Only two parts relate to fire safety in buildings: Parts 3 and 9.

Part 3 applies to:

- all places of assembly
- all care and detention facilities such as hospitals, nursing homes and detention centers
- all high hazard industrial buildings
- all other types of buildings over three storeys or 600m² in area

Part 9 applies to buildings of three storeys or less up to 600m² in area, except for assembly, care and detention or high hazard industrial buildings.

This document deals essentially with Part 3 of the *NBCC* though references are made to Part 9 from time to time.

The basic fire safety objectives of the *NBCC* are explained as well as the rationale for:

- compartmentation
- flame-spread ratings
- means of detection and alarm
- means of egress
- fire-resistance ratings
- spatial separation
- fire suppression systems
- provisions for firefighting

Code references are indicated throughout as **3.2.2.26**. Official Code Definitions of terms are indicated by underlining the term and the definition is in quotation marks.

Special emphasis is given to the use of wood and wood products in buildings of all types, including those required to be of non-combustible construction.



1.2 Fires that Shaped the Code

After 1904, the year of the Bay Street fire in Toronto, improvements in building construction and firefighting equipment appeared to stem the rash of fires which had destroyed downtown districts.

The building codes in effect at the beginning of the century reflected an understanding of the need for fire-resistive construction and the protection of openings.

FIGURE 1.3

Fire claimed 492 lives at Boston's Coconut Grove in the fall of 1942. It had a significant impact on regulations for exits and interior finishes



Further refinements in building codes evolved from single property tragedies. Contributing factors typically included:

- inadequate building construction
- lack of egress facilities
- poor or non-existent alarm systems

COCOANUT GROVE NIGHTCLUB

The notorious fire at Boston's Coconut Grove in 1942 had a significant impact on public consciousness.

At the time of the fire, the Coconut Grove nightclub was crowded far beyond capacity. The official seating capacity of the lounges and bars was about 600, but about 1,000 people occupied the one-storey building. In the basement, the Melody Lounge was also over full.

The walls and low ceiling of the lower lounge were covered with a cotton fabric and decorated with flammable artificial coconut palms. At about 10 p.m., something ignited as a bus-boy was replacing a light bulb near one of the artificial trees. Fire swept over the heads of the patrons with incredible speed as it caught the decorations. Within seconds, flames filled the only visible means of exit, a stairway at the rear of the lounge.

Flames soon reached the ground floor, swept across the ceiling and enveloped each room with such speed that people had no time to react. Most tried to escape through a revolving door which soon jammed under the pressure.

Several other doors through which people could have escaped were locked or hidden from view. As smoke filled the building, people were overcome by the noxious fumes; some died sitting at their tables. By the time it was over, 492 people had lost their lives.

The contributing factors in this tragic incident in a meeting place are obvious:

- it was overcrowded
- decorations were highly combustible
- exits were few, poorly lit, unmarked, locked or blocked
- exits did not open in the direction of exit travel

These same contributing factors played a significant role in a similar tragedy which occurred in 1977 in Kentucky. The Beverly Hills Supper Club fire was the worst multiple-death building fire in the United States since the Coconut Grove fire, resulting in the loss of 164 people.

LAURIER PALACE THEATRE

Another fire incident, which occurred in Montreal on January 9, 1927, claimed fewer casualties than the Coconut Grove fire. However, with one exception, all were children under the age of 16.

At the time of the fire, the Laurier Palace Theatre was filled to capacity. The fire station was directly across the street. When the alarm sounded, firefighters went into action immediately. On entering the building, they discovered, to their horror, that bodies were piled

in a solid mass in one of the narrow stairways leading from the balcony.

The stairs were steep, enclosed by walls and narrowed at the bottom. One of the children had obviously stumbled and caused the others, rushing toward the exit, to trip and fall. Smoke kept driving people down the stairs

and the pile grew bigger and became more solidly wedged in the passageway.

In the end, 78 children had died, 52 died of asphyxiation, 25 were crushed to death and 1 burned. For the next 40 years or so, children were prohibited from motion picture theatres in the province of Quebec.

FIGURE 1.4

A fire on the ground floor of Chicago's 22-storey LaSalle Hotel, considered to be a "fire-resistant" building, sent hot gases through the ventilation system to the upper floors, forcing evacuation.



CATASTROPHIC HOTEL FIRES

In 1946, three major hotels in the US suffered severe fires which cost many lives:

- the LaSalle Hotel in Chicago
- the Canfield Hotel in Dubuque
- the Winecoff Hotel in Atlanta

These fires increased awareness of the safety problems inherent to these occupancies in tall buildings, and the unpredictable behaviour of people in cases of dire emergency.

The LaSalle was considered a fire-resistive hotel. The 22-storey building was constructed of protected-steel frame and reinforced concrete, with brick exterior walls and 3-inch plastered hollow tile partitions. It even featured three enclosed noncombustible stairways, though they did not open directly to the outside at ground level.

Unfortunately, the building's weaknesses came to light in June, 1946, when a fire broke out in the cocktail lounge on the ground floor. The exhaust ventilation from the lounge discharged into the elevator shaft, sending hot gases directly to the upper floors. The lobby and mezzanine were decorated with walnut veneer panelling and were connected to an open stairway to the upper floors. In addition, the bedroom doors had transom windows, and many were open at the time of the fire.

One of the disturbing aspects of this fire was the way in which people reacted. Many fell to their death by jumping from windows or trying to escape by climbing down bed sheets tied together. Similar behaviour was seen in later fires including one at the Taeyonkak Hotel in Seoul, South Korea, in 1971.

FIGURE 1.5

A welder's torch ignited combustible insulation material in the basement of the highrise CIL House, Montreal in 1962

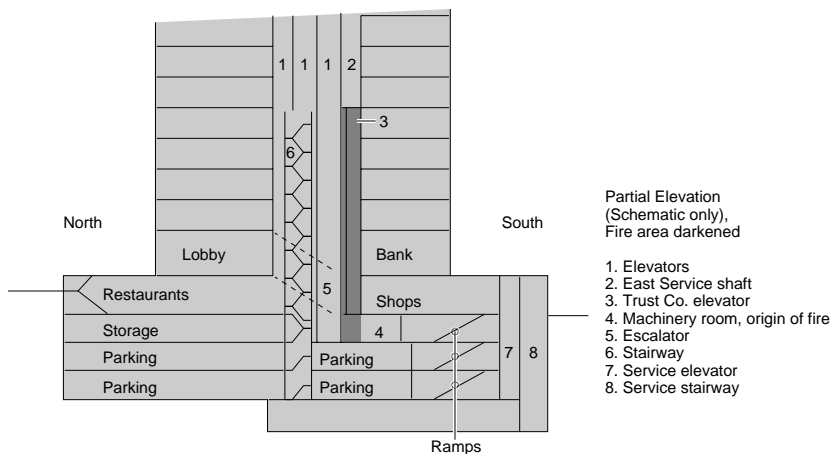

Smoke from fire that fed on combustible insulation on pipes and ducts in a service shaft forced 3,000 people in this 36-storey building to leave. The fire was confined to the shaft and did not get above the fourth-storey level.

Source: NFPA Quarterly — October 1963

Similarly, at the Canfield and Winecoff hotels, a lack of compartmentation hastened the spread of smoke, heat and flames up open staircases and through open transom windows into guest rooms. Another significant factor was a delay in alerting occupants to the fire.

At the Winecoff Hotel, where 122 people lost their lives, there was no automatic alarm system in the building. It is estimated that the fire burned for at least half an hour before the fire department was notified.

More recent fire losses in hotel occupancies include:

- MGM Grand Hotel in Las Vegas in 1980 (84 deaths)
- Dupont Plaza Hotel in San Juan, Puerto Rico in 1986 (96 deaths)

Both fires originated in and around the casinos on the lower floors of the building. Lack of sprinklers and unprotected floor openings were cited as major factors in the spread of smoke and fire into high rise portions of the building.

HIGHRISE FIRES

In the latter part of the 1960s and the early 1970s, attention focused on the fire safety of highrise buildings.

Though usually of fire-resistive construction, these buildings had a number of design deficiencies. These centred around the vertical shafts required for building services, such as elevators, stairs, pipes, ducts and electrical cables.

These shafts are subject to what is called the “stack effect.” In cold weather, the heating of a building draws air into the building at low levels and out at upper levels. The natural movement of warmer air from bottom to top is caused by pressure differentials from temperature differences at the exterior boundaries of the building.

In addition, taller buildings house a larger number of people who have a longer route to evacuation. Studies by NRC and the US National Bureau of Standards (now National Institute of Standards and Technology) show that evacuation of tall buildings can take up to two hours.

The fire at the CIL House in Montreal in December, 1962, typified the potential for disaster in highrise structures.

At about 10 a.m., welders working on ducts in a service area on the second basement level accidentally set fire to combustible pipes or duct coverings. The small fire quickly spread upward because of the natural draft in the service shaft, and smoke began spreading throughout the structure as the fire consumed the combustible insulation and coverings within the shaft.

The alarm system which sounded throughout the entire building at one time, proved inadequate. Evacuation was delayed as floor managers far removed from the start of the fire, and unaware of the reason for the alarm tried to assess the situation.



Eventually, employees were told to evacuate. The almost simultaneous evacuation of all floors resulted in crowded, smoke-filled darkened stairwells with no emergency lighting. Fortunately, there were no casualties.

Other fires in highrise buildings attracted attention and had more tragic outcomes.

The fire at Dale's Penthouse Restaurant in Montgomery, Alabama, killed 25 people. Although the structure was only 10 storeys, the occupants of the restaurant on top of the building were beyond the reach of fire department ladders.

Another fire in the Rault Center in New Orleans, Louisiana, resulted in six deaths. Five women in a beauty salon on the 15th floor became trapped, while a man died of smoke inhalation in an elevator. Again the fire began on a floor that could not be reached by aerial ladders.

A recent fire at the Forest Laneway high-rise apartments in North York, Ontario resulted in six deaths. Stack effect is believed to have contributed to the loss. The fire originated and was mainly contained to the fifth floor yet all the casualties were located above the 20th floor. (Figure 1.6)

Tall buildings remain controversial today. The question, "Who would dream of constructing a building over 500 feet long, housing several thousand people, but with exits only at one end?" is still heard.

Intensive pioneering research at IRC has resulted in elaborate requirements for smoke venting which are referenced in the *NBCC*. Though it is acknowledged that these measures for smoke control are sometimes difficult to achieve, the research has contributed to the understanding of problems of smoke movement in tall buildings.

LESSONS LEARNED

From the 1950s to the early 1970s, a number of tragic fires in hospitals, schools and nursing homes heightened public awareness of the potential for disaster in such buildings. Hospitals were (and are) particularly vulnerable because of the difficulty of moving patients. Furthermore, many of the buildings were of an older design, with open stairways, corridors and vertical shafts, no sprinklers, and no automatic fire detection and alarm systems.

The lessons learned from these and other past fires had a direct impact on the shaping of building codes. Both in Canada and the US, existing regulations were revised and augmented to prevent recurrence of such tragedies. Over the years these revisions have included such things as:

- noncombustible construction being stipulated for some buildings
- limits being placed on the flammability of building materials
- introduction of compartmentation concepts

- requirement for fire alarms and means of fire detection
- improvements in means of egress

Many older buildings violated many of the fire safety principles which now form the basis of the *NBCC*. These principles are discussed in detail in Chapter 3.

FIGURE 1.6

Recent fires continue to emphasize the fire hazards of high-rise structures



1.3 Development of the NBCC

Once a closed process, the development of the *NBCC* and its associated documents has become much more open in recent years, allowing for input from all segments of the building community.

In preparation of the 1995 Code, the former Associate Committee of the National Building Code was merged in 1991 with the Associate Committee of the National Fire Code to form the Canadian Commission on Building and Fire Codes (CCBFC).

This Commission is composed of 30 to 35 leading Canadian citizens in the field of construction. It gives policy guidance to a number of Standing Committees which are responsible for the technical aspects of one or more parts of the *NBCC*. The Commission, in turn, receives guidelines on matters relating to the *NBCC* from provincial and territorial code authorities through the Provincial/Territorial Committee on Building Standards (PTCBS).

TABLE 1.1

NBCC Standing Committee on Fire Protection

Interest to be Reflected	Minimum Number of Members	Sources to be Drawn From
Regulatory		
Building Officials	3	Provincial, territorial and municipal regulatory authorities
Fire Officials	2	Provincial and territorial fire marshals' or fire commissioners' staffs, municipal fire services (fire chiefs or fire prevention officers)
Federal agencies enforcing building regulations	1	Federal agencies
<i>Sub-total</i>	6	
Industry		
Building owners or developers	1	Building owners or developers with technical capability and an awareness of cost
Construction managers or building contractors	1	Construction managers or building contractors with a knowledge of building materials and construction methods
Manufacturers, fabricators or their associations	4	Major material interests
<i>Sub-total</i>	6	
General Interest		
Architects	2	At least one from the private sector
Engineers	2	At least one from the private sector
Research and testing	2	Testing and inspection agencies including provincial and municipal laboratories
Total	18	

Source: Canadian Commission on Building and Fire Codes Policies and Procedures, 1992.



Efforts by the CCBFC and IRC have made the *National Building Code of Canada (NBCC)* the basis for most provincial and municipal building regulations in Canada. The *NBCC* has demonstrated clearly the validity of the consensus approach through which it is developed and maintained.

The *NBCC* is not a federal document produced by the National Research Council of Canada. However, NRC is its publisher and maintains copyrights. The *NBCC* is a national model code and its content is the sole responsibility of the CCBFC.

STANDING COMMITTEES OF THE CCBFC

Between 1990 and 1995, there were nine active Standing Committees. The composition of each Standing Committee follows a matrix established by a Nominating Committee of the CCBFC.

Each matrix tries to ensure an appropriate mix of expertise by drawing from every major sector of the construction industry. The Nominating Committee makes every effort to obtain as wide a geographical distribution as possible in filling the positions, thus making the *NBCC* a truly national document (see Table 1.1).

Members of Standing Committees are appointed on the strength of their knowledge and professional interest, and not as direct representatives of a particular industry, association or interest group. This approach keeps discussions as free and uninhibited

as possible. Members give their time and expertise without remuneration; they are reimbursed only for traveling expenses incurred to attend meetings.

Standing Committees often appoint task groups to help with the task of evaluating information. These committees of experts address specific questions which require specialized knowledge. The reports of these task groups often lead to changes in the Code.

For example, in preparing the proposed changes for the 1995 *NBCC*, a special task group was created to study all aspects of the use of automatic sprinkler systems. As a result of this task group's work, significant changes related to sprinklers were adopted in the 1995 *NBCC*.

Over 250 individual members contributed to the 1995 *NBCC* at an estimated personal cost of over \$6 million. Those who feel they have knowledge to contribute to this ongoing process should contact the Secretary of the Commission (see address in the list of organizations at the back of the book).

CANADIAN CODES CENTRE

The effectiveness of Code Committees depends, of course, on the contribution of its members and on good technical and secretarial support. The primary function of IRC's Canadian Codes Centre (formerly the Codes Section) is to provide such support. The Centre ensures that the Committees have the information to enable them to make enlightened decisions.

The Centre co-ordinates input from the Research Sections of IRC, such as the Acoustics Laboratory and the National Fire Laboratory, and from other sources. Committees also rely on technical staff at the Centre to:

- review public inquiries
- draft proposed code revisions
- draft new requirements in the code
- review public comments on proposed changes

This ensures that valuable time is not wasted by the Committees in collective drafting and to ensure uniformity. The final responsibility for the technical content of the Code, however, rests with the Committees.

The Codes Centre provides secretarial support by preparing agendas and minutes and is responsible for editing, translating and printing documents.

CODE CHANGE CYCLES AND PUBLIC INPUT

The *NBCC* and its associated documents, such as the *National Fire Code of Canada* and the *Canadian Plumbing Code*, have been published every five years. During any five-year code-revision cycle, there are many opportunities for the Canadian public to contribute to the process.

Correspondence is the primary mechanism through which input is made to the Committees. Anyone who encounters difficulties in applying *NBCC* requirements can write to the Secretary of the CCBFC.

The proponent is required to outline the problem and include proposed code change language in sufficient detail so that it can be properly evaluated by staff and Committees. The public proposals are brought to the attention of the relevant Committee, unless it is a straightforward issue that can be addressed by staff. The correspondent is subsequently informed of any decisions made by the Committee as a result of the inquiry.

Members of the public are also welcome to attend meetings, as observers or participants, subject to rules of order. An observer cannot be party to discussions but a participant is permitted to make a presentation and answer questions from the Committee. Participants are invited at the prerogative of the Chairman who will usually base his or her choice on the relevance of the subject.

The most inclusive vehicle for contribution is the Public Review Process. At least twice during the five-year cycle, proposed changes to the Code are published and the public is invited to comment. This procedure is crucial as it allows input from all those concerned and broadens the scope of expertise of the Committees.

Thousands of comments are received and examined by the Committees during each cycle. A proposed change may be approved as written, modified and resubmitted for public review at a later date, or rejected entirely. Those who submit comments are informed of Committee decisions.



RELATIONSHIP BETWEEN THE NBCC AND THE NFCC

The *National Building Code of Canada (NBCC)* and the *National Fire Code of Canada (NFCC)* are developed as companion documents. The relationship between the two documents can be better understood when their respective purposes are considered.

The *NBCC* establishes minimum standards for the health and safety of the occupants of new buildings. It also applies to the alteration of existing buildings, including changes in occupancy.

The *NBCC* is not retroactive: in other words, a building constructed in conformance with a particular edition of the *NBCC*, in effect at the time of its construction, is not automatically required to conform to the next edition of the *NBCC*. That building would only be required to conform to the new regulations if it were to undergo a change in occupancy or alterations which invoke the application of the new *NBCC* in effect.

In 1993, the document, *Guidelines for the Application of Part 3 of the National Building Code of Canada to Existing Buildings*, was published by NRC. It provides guidelines on the intent of the requirements of the *NBCC* and how those requirements might be applied to existing buildings.

A huge proportion of Canadian building stock was constructed before modern building codes were in effect. Upgrading these buildings poses a challenge

because conformance with new Code requirements can be very expensive.

To make renovations financially feasible authorities having jurisdiction may sometimes consider trade-offs or alternatives which will provide an equivalent level of safety. This forces the authority to assess the intent and objective of requirements, a process which will inevitably be reflected in the evaluation of requirements for new buildings.

The requirements in the *NFCC*, on the other hand, are intended to ensure the level of safety initially provided by the *NBCC* is maintained. With this objective, it regulates:

- the conduct of activities causing fire hazards
- the maintenance of fire safety equipment and egress facilities
- limitations on building content, including the storage and handling of hazardous products
- the establishment of fire safety plans

Major revisions to the 1995 edition of the *NFCC* involved changes related to the indoor and outdoor storage of various commodities and protection of indoor hazardous processes.

The *NFCC* is intended to be retroactive with respect to fire alarm, standpipe and sprinkler systems. In 1990, the *NFCC* was revised to clarify that such systems “shall be provided in

all buildings where required by and in conformance with the requirements of the *National Building Code of Canada*.”

This ensures that buildings are adequately protected against the inherent risk at the same level as the *NBCC* would require for a new building. It does not concern other fire protection features such as smoke control measures or fire-fighter’s elevators. The *NFCC* also ensures that changes in building use do not increase the risk beyond the limits of the original fire protection systems.

The *NBCC* and the *NFCC* are written to reduce to a minimum the possibility of conflict in their respective contents. They are complementary; the *NFCC* takes over from the *NBCC* once the building is in operation. In addition, older structures which do not conform to today’s fire safety standards can be made safer through the requirements of the *NFCC*.

It is important that building and fire officials be familiar with both codes. This will help ensure that all known hazards have been considered and that a satisfactory standard of fire safety achieved.



1.4 CCBFC Strategic Plan and Objective Based Codes

The Canadian Commission on Building and Fire Codes (CCBFC) is shifting away from prescriptive requirements to a greater emphasis on an “objective-based” approach to building design in the *NBCC*.

Prescriptive requirements describe precisely the types of material and assembly to be used in particular circumstances. Such requirements make alternative design solutions difficult because the enforcement official has no indication of the reason for the requirement.

On the other hand, performance-based requirements, set forth objectives which must be met to achieve a given level of safety. This provides the greatest level of

flexibility since authorities can measure the solution provided by the designer against the given objectives. The 1995 *NBCC* still contains a large number of prescriptive requirements but the emerging trend is toward performance criteria.

This move to objective-based design will help in the introduction of new materials, systems and processes. Those responsible for their evaluation will be able to measure these solutions against clear statements of intent of *NBCC* requirements. The evaluation process will be further facilitated through the Canadian Construction Materials Centre

CCMC

The Canadian Construction Materials Centre (CCMC), at the National Research Council in Ottawa, offers a national evaluation and listing service for innovative or previously uncertified products. Manufacturers submit products for testing at an approved laboratory to meet the criteria of either a CCMC Evaluation Directive if there is an existing applicable standard, or a CCMC Technical Guide written for new products for which no standards exist. Products covered by a certification program recognized by the Standards Council of Canada are not evaluated by CCMC.

The CCMC publishes and distributes evaluations and listings in separate volumes. The listings are renewed annually and reviewed a minimum of once every three years. The reviews cover in-plant quality control programs, installation and maintenance instructions, guarantees and warranties as well as product identification and performance. However, CCMC does not carry out ongoing in-plant inspection and quality assurance checks.



(CCMC) which, under the management of IRC, has a more direct input into the *NBCC* development process.

During the last two years of the 1995 code-change cycle, concerns arose within the CCBFC regarding a number of issues affecting the future of model codes in Canada. These included:

- international trade and its effect on manufacturers and regulators
- need to expand scope of codes to include such things as environmental and other societal issues, commissioning and life cycle considerations
- need to limit scope of the code to the basics of health and safety and structural sufficiency
- increasing complexity of codes
- impact of codes on cost to industry and the public

In 1995, the CCBFC approved a strategic plan intended to deal with Canadian needs for building and fire regulations.

As a result, there were six major goals identified for the CCBFC. These are (in order of priority):

- **Goal 1.** To provide national and model codes that meet the needs of all code users in Canada
- **Goal 2.** To have future national model codes adopted without modification by all authorities having jurisdiction in Canada
- **Goal 3.** To have uniform interpretation and understanding of code requirements throughout Canada

- **Goal 4.** To have a responsive, objective and effective code development system
- **Goal 5.** To strengthen the Commission's role
- **Goal 6.** To be substantially self-funding

As part of the strategy around the first goal, it was agreed that one major objective should be that "all model codes be current, understandable, justifiable, logical, flexible and co-ordinated." To achieve this objective, it was further agreed that an "objective-based code structure, reflecting identified needs" be developed. A target date of the year 2001 was chosen.

A CCBFC task group on Objective-Based Codes began its work in early 1996 on the development of the plan for transforming the national model codes into an objective-based framework.

As part of this transformation, the activities of all the current Standing Committees have been significantly curtailed to only address issues having significant economic or safety implications. Where such issues arise, changes in the current 1995 *NBCC* would be considered.

New Standing Committee structures developed by the task group will be in place by the Fall of 1996. The goal is to have a set of interim support documents in 1998 that will be based on the intent of the current (1995) Codes and identify the major objectives and sub-objectives of the Code. In 2001 the objective-based code document will be completed by

identifying functional requirements and the various approved solutions which could include either prescriptive or performance solutions (see insert).

For complete information on the topic and work by the CCBFC toward this objective-based code, readers may obtain copies of the following documents from the Secretary of the CCBFC:

BUILDING THE FUTURE The Strategic Plan of the Canadian Commission on Building and Fire Codes 1995 - 2000

Possible Measures to Implement the Strategic Plan of the CCBFC

Objective Based Codes: A New Approach For Canada

Sample Glossary of Terms

Objective-based Code — A code with a structure based on a hierarchy of objectives and sub-objectives.

Objective — A statement of the outcome that compliance with a code or part thereof is expected to achieve.

Sub-objective — One of a group of related objectives, the satisfaction of which contributes to satisfying a related higher level objective.

Functional Requirement — A detailed sub-objective at the highest level in the hierarchy at which the objective can be expressed in quantitative terms.

Approved Solution — An expression of one or more means deemed to satisfy a functional requirement or higher level objective. Such expression may be in the form of a prescriptive solution or a performance solution.

Prescriptive Solution — A specific statement of building elements (materials, components, assemblies, systems or equipments) that can be used and/or procedures that can be carried out to satisfy the terms of a functional requirement.

Performance Solution — A statement of the level of performance that a building element (material, component, assembly, system or equipment) or procedure must provide to satisfy the terms of a functional requirement. A performance solution specifies the aspect of the element's performance that is being established, the methods that are used to measure performance and the criteria that are used to evaluate success or failure.

Source: Objective Based Codes; A New Approach For Canada, NRCC, Institute for Research in Construction, Ottawa, February, 1996.





Chapter Summary

The *National Building Code of Canada* is a highly regarded model building code. Its origins are deeply entrenched within Canadian history and culture and a need to house the growing population of Canada safely and economically.

Historical events have shaped many of the health and safety requirements of the *NBCC*.

Worldwide, codes are moving toward more performance-based requirements. The *NBCC* is working toward an objective-based code by the year 2001. This approach will allow the implementation of various design and construction methods as long as they can meet the clearly stated objectives. The code will still detail prescriptive solutions that comply with these objectives.



2



Building with Wood

2.1	General Information	29
2.2	Structural Systems in Wood	31
	Wood-Frame Construction	31
	Heavy Timber Construction	33
2.3	Wood in Noncombustible Buildings	39
	Wood Furring	40
	Fire Stop	41
	Roofs	41
	Window Sashes and Frames	41
	Combustible Cladding and Fascias	42
	Millwork	44
	Flooring Elements	45
	Wood Partitions	45
	Stairs and Storage Lockers	46
	Wood Finishes	46
	Chapter Summary	48



2.1 General Information

Wood was one of the earliest materials used in construction. Its advantages are obvious. In addition to being in ample supply, wood's advantages include:

- renewable supply
- strength in both tension and compression (stronger than steel by weight)
- easily worked with simple tools
- extremely flexible
- unparalleled warmth and beauty

Wood has another inherent property: it burns.

After some of the conflagrations experienced during the last century, legislators sought to limit the use of wood-frame construction in favor of fire-resistive stone or brick construction. However, as J. Grove Smith pointed out in his 1918 report of the Commission of Conservation, *Fire Waste in Canada*:

The typical “fireproof” building, having merely incombustible floors, roofs and walls, cannot control a conflagration any more than can an ordinary brick building with a good roof. A conflagration moves laterally and a “fireproof” building in its path, as evidenced in many of the larger fires, is merely a crate which holds up the fuel contents in position for free burning. The contents in buildings make up the bulk of property loss, and repeated experience

Many varieties of wood components create structural forms

shows that no building can withstand the heat due to the burning of a large quantity of merchandise.

Early building regulations were intended to protect property on purely economic grounds; owners wanted to protect their investment against fire in adjacent properties. As buildings grew taller, this became imperative. The idea of a building like the Empire State collapsing on adjacent properties understandably raised concern.

Initially, structural fire resistance was given paramount importance. Later, the safety of the occupants and firefighters became a primary objective of building regulations.

Even materials that do not sustain fire do not guarantee the safety of a structure. Steel, for instance, quickly loses its strength when heated and its yield point decreases significantly as it absorbs heat, endangering the stability of the structure (Figure 2.1). An unprotected, conventional open-web steel joist system will fail in less than 10 minutes under standard fire exposure test methods, while a conventional wood joist floor system can last up to 15 minutes.

Even reinforced concrete is not immune to fire. Though concrete structures have rarely collapsed, concrete will spall under elevated temperatures, exposing the steel reinforcement and weakening structural members.



FIGURE 2.1

Steel loses strength at elevated temperatures

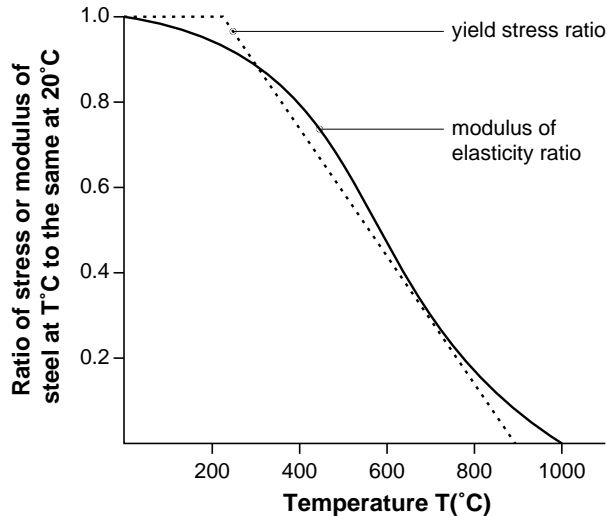

Source: *Fire Engineering Design Guide*,
University of Canterbury, New Zealand, 1994

It is recognized then, that there is really no such thing as a fireproof building. Fires can occur in any type of structure. The severity of a fire, however, is contingent on the ability of a construction to:

- confine the fire
- limit its effects on the supporting structure
- control the spread of smoke and gases

To varying degrees, any type of construction can be designed as a system, that is, a combination of construction assemblies, to limit the effects of a fire. This allows

occupants sufficient time to escape the building and for firefighters to safely reach the seat of the fire.

Occupant safety also depends on other parameters such as detection and exit paths, and the use of automatic fire suppression systems such as sprinklers. These concepts form the basis of the *NBCC* and are further explored in Chapter 3.

This chapter discusses the most common types of wood structures used in Canada as well as the uses of wood in noncombustible buildings.

2.2 Structural Systems in Wood

Structural systems in wood can be divided into wood-frame and heavy timber construction.

These two types of construction have important differences. They relate to:

- the size of the wood members
- the methods of assembly
- the degree to which they must be combined with other materials to achieve fire-safe conditions

The type of construction permitted, wood-frame, heavy timber or non-combustible depends on building size and use. Chapter 4 describes building classification according to occupancy, building height and area.

WOOD-FRAME CONSTRUCTION

Most houses in Canada are wood-frame construction. This method of construction uses lumber 38mm thick, in depths from 89mm to 286mm, and members are spaced at a maximum of 600mm on centre.

Wood-frame construction is generally regulated by Part 9 of the *NBCC, Housing and Small Buildings*. However, it can also be used for Part 3 buildings permitted to be of combustible construction.

In such cases, the span tables in Part 9 cannot be used since Part 3 requires structures to be engineered

FIGURE 2.2

Wood-frame construction



in accordance with Part 4, *Structural Design*. Part 4 requires wood structures to be designed in accordance with Canadian Standards Association (CSA) Standard O86.1, *Engineering Design in Wood – Limit States Design*. For design methods and tables see the *Wood Design Manual* by the Canadian Wood Council.

The span tables in Part 9 are calculated based on criteria developed from years of experience.

A-9.23.4.2.(2) In the 1990 *NBCC*, a vibration control criteria was added to the strength and deflection criteria for the span tables. Vibration control is based on the floor as a system and takes into

account practices such as bracing and gluing. This criteria was developed to reduce the likelihood of springy floors. Vibration criteria should be applied to all floor systems for Part 9 buildings.

In the 1995 *NBCC*, more tables were added and expanded to cover a greater variety of constructions.

Though the structure of a modern wood-frame building may be made entirely of wood, protective finishes such as gypsum wallboard can be applied to the framing to provide fire resistance where required.

A fire-resistance rating is determined by the amount of time that an assembly resists the passage

FIGURE 2.3

Heavy timber construction



TABLE 2.1

Minimum dimensions of wood elements in heavy timber construction

Supported Assembly	Structural Element	Solid Sawn (width x depth) mm x mm	Glue-laminated (width x depth) mm x mm	Round (diameter) mm
Roofs only	Columns	140 x 191	130 x 190	180
	Arches supported on the tops of walls or abutments	89 x 140	80 x 152	–
	Beams, girders and trusses	89 x 140	80 x 152	–
	Arches supported at or near the floor line	140 x 140	130 x 152	–
Floors, floors plus roofs	Columns	191 x 191	175 x 190	200
	Beams, girders, trusses and arches	140 x 241 or 191 x 191	130 x 228 or 175 x 190	– –

Source: National Building Code of Canada, 1995.

of heat and flames. This concept is explained in Chapter 5. Wood-frame assemblies can economically be made to resist the effects of a fire for up to two hours through the use of appropriate materials and construction methods. Experience has proven this construction system to be reliable and safe.

Wood frame floor and wall assemblies have been tested and are listed with varying degrees of fire resistance from 45 minutes to two hours.

HEAVY TIMBER CONSTRUCTION

Large dimension wood sections have an inherent resistance to fire. Wood burns slowly at approximately .6mm/minute. The char created on the wood surface as it burns helps protect and insulate unburnt wood below the charred

layer. The unburnt portion of a thick member retains 85 to 90 percent of its strength.

Hence, a wood member with a large cross-section can burn for a significant amount of time before its size is reduced to the point where it can no longer carry its assigned loads.

Heavy timber construction is defined as: “a type of combustible construction in which a degree of fire safety is attained by placing limitations on the sizes of wood structural members and on thickness and composition of wood floors and roofs and by the avoidance of concealed spaces under floors and roofs.”

Both solid-sawn and glue-laminated members qualify under this definition provided they have the minimum sizes given in Table 2.1.

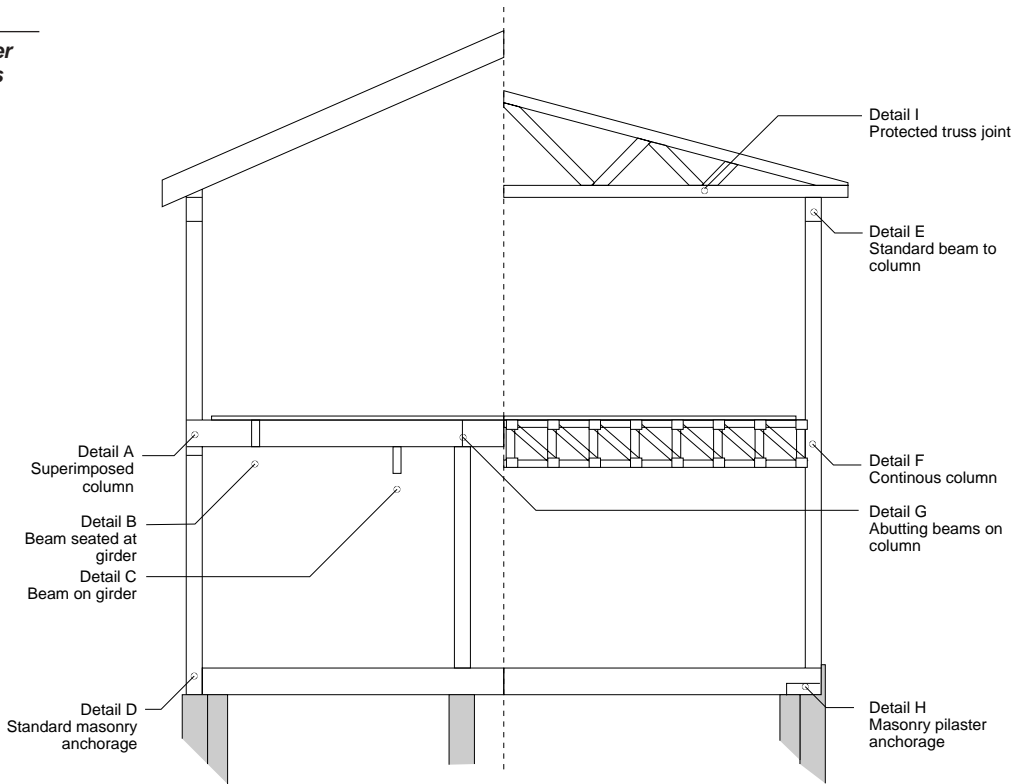

FIGURE 2.4

Heavy timber connections

Note:
Refer to Figure 2.5 for Details (A) to (H) and Figure 2.6 for Detail (I)

Of course, they must be designed to carry the expected loads and actual dimensions must conform to *CSA Standard O141, Softwood Lumber*.

Various types of connections are shown in Figure 2.4, with details following in Figures 2.5 and 2.6.

3.1.4.6.(1) To satisfy heavy timber requirements wood elements must be arranged in solid masses with essentially smooth, flat surfaces to avoid thin sections and sharp projections. This is to reduce to a minimum the surfaces which can be exposed to fire.

3.1.4.6.(4) For the same reason, when roof arches, trusses, beams or girders are made from several pieces, the connection elements must be a minimum of 64mm thick and be protected by sprinklers. Where not protected by sprinklers, they must be built so that they constitute a solid mass or have the voids blocked off on the underside by a continuous wood cover plate at least 38mm thick (Figure 2.6).

FIGURE 2.5

Connection details

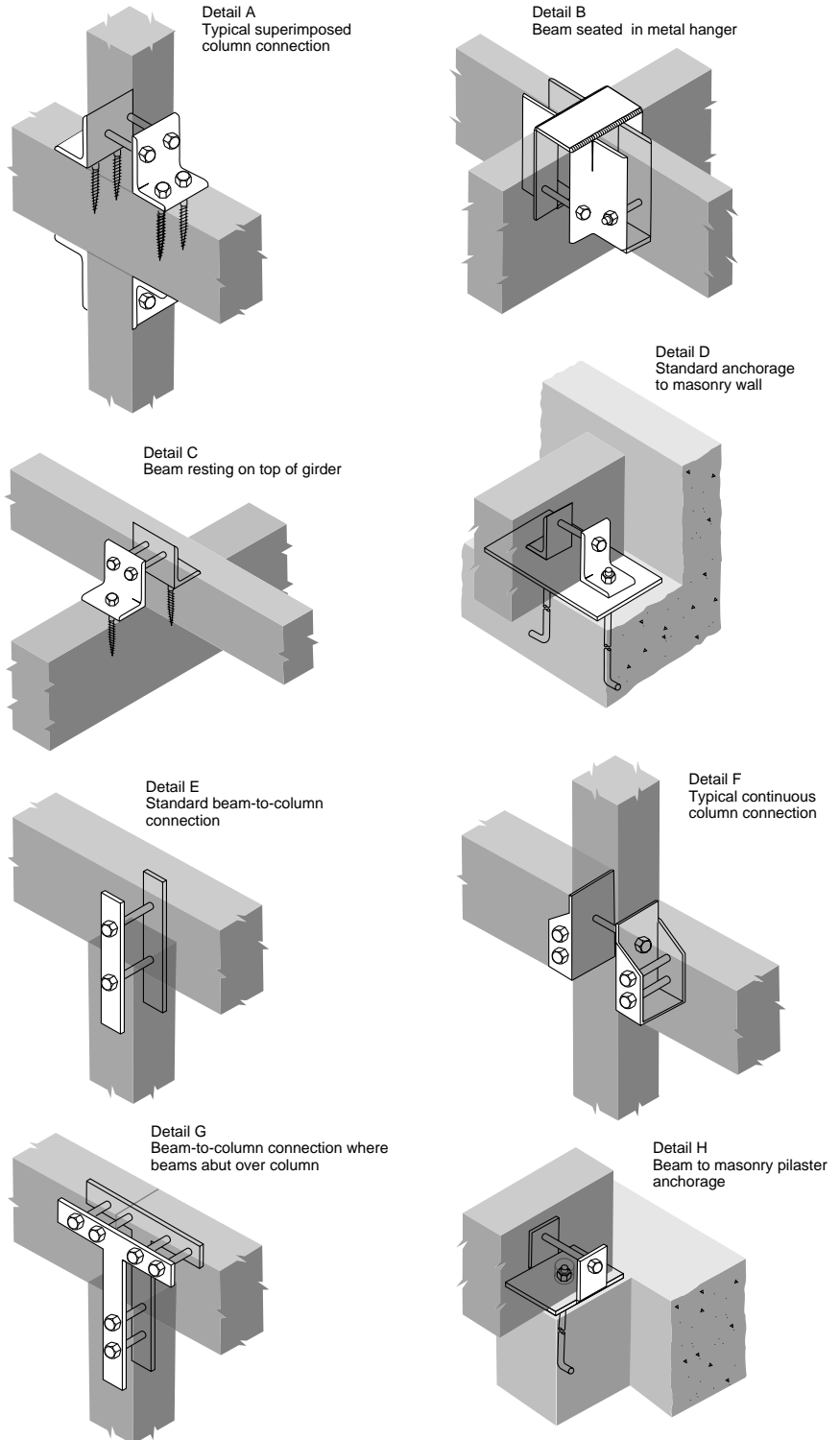

FIGURE 2.6

**Detail I
Built-up
truss joint**

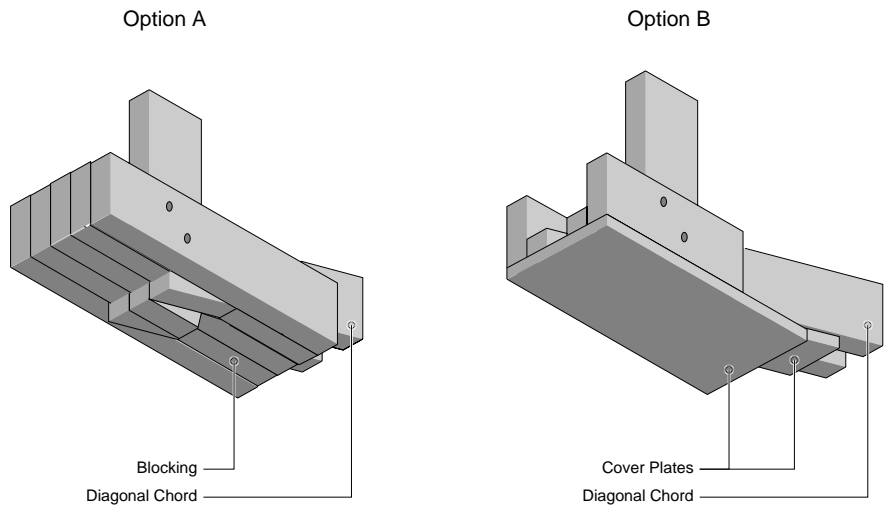
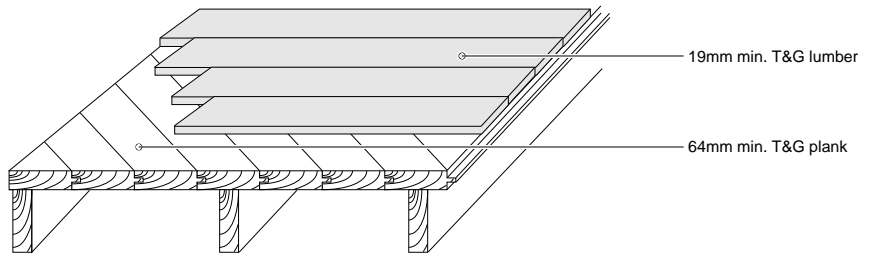
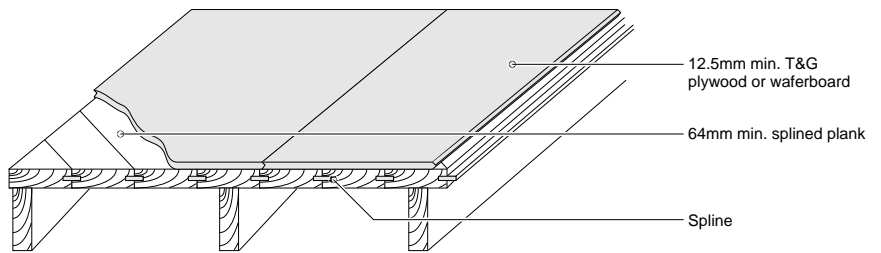

FIGURE 2.7

Floor decks



Tongued and Grooved (T&G) Plank



Splined Plank

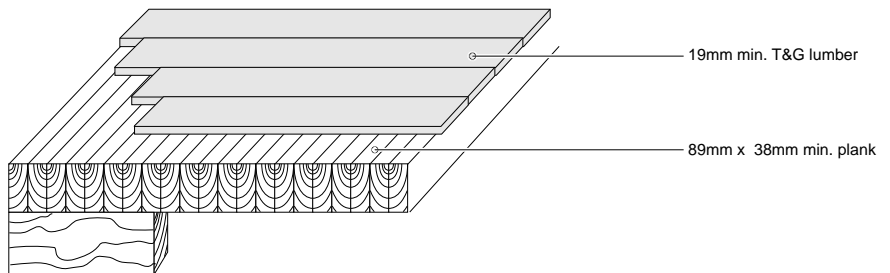

Spiked Plank on Edge

3.1.4.5. In addition to minimum member size, a number of other *NBCC* requirements are intended to ensure that the advantages of heavy timber construction are not affected by poor assembly. When these requirements are met, the *NBCC* considers heavy timber construction as equivalent to 45-minute rated combustible construction (Chapter 5).

In sprinklered buildings permitted to be of combustible construction, no fire-resistance rating is required for the roof assembly or its supports. In these cases, a heavy timber roof assembly and its supports would not have to conform to the minimum dimensions stipulated in the *NBCC*.

In the case of the use of heavy timber in noncombustible construction, which is permitted in both sprinklered and unsprinklered cases, the minimum dimensions must always be met. This is covered in greater detail in Chapter 4.

D-2.11 It is possible for heavy timber construction to have a one hour fire-resistance rating. A calculation method for determining the fire-resistance rating of glue-laminated beams and columns is found in Appendix D of the *NBCC*. It includes descriptions of wood deck assemblies which can be assigned a one hour fire-resistance rating. This calculation method is discussed later in Chapter 5.

3.1.4.6.(8) To meet heavy timber requirements wood columns must be continuous or superimposed

through all storeys. Types of columns permitted include:

- solid sawn timber
- glue-laminated elements
- uniformly tapered poles

Superimposed columns must be aligned with the vertical axis of the column below. They must also be adequately anchored to the girder or beam with brackets or other types of connectors suitable for heavy timber construction. (for example, Detail A, Figure 2.5)

3.1.4.6.(11) Heavy timber girders and beams connected to continuous columns must be closely fitted and adjoining ends must be cross-tied to ensure structural integrity. Similarly, intermediate beams attached to girders must be closely fitted.

3.1.4.6.(10) Heavy timber beams and girders supported on masonry walls must bear on wall plates, indented surfaces or hangers. This connection must be designed so that the collapse of the beam or girder under fire conditions will not cause the collapse of the wall; this is particularly important in the case of firewalls.

3.1.4.6.(5)&(6) Heavy timber floors are usually constructed with solid sawn planks. When laid flat, they must be tongue-and-groove, or splined. Splined planks are held together by strips of wood called splines, which are inserted into grooves cut into opposing edges of abutting planks to form a continuous joint.



Planks laid on edge must be spiked together. Planks must be laid so that joints occurring in the middle of a span are staggered; a continuous line of end joints is permissible only over points of support, such as a beam.

Planks must then be covered by 19mm tongue-and-groove lumber laid across or diagonally, or by 12.5mm phenolic-bonded plywood, oriented strandboard (OSB) or waferboard. A 15mm clearance to end walls should be allowed for expansion, and the gap between flooring and wall must be firestopped at the top or bottom with lumber or plywood.

Figure 2.7 shows some typical details of heavy timber floor deck construction.

3.1.4.6.(7) Heavy timber roof decks may be constructed of 38mm (minimum) solid sawn planks assembled in the same way as for floors, or of tongue-and-groove phenolic plywood at least 28mm thick. In addition to offering lower installation cost, 28mm plywood has performed as well as traditional heavy timber decking in standard fire tests.

Heavy timber construction is otherwise subject to the same requirements for roof coverings and concealed spaces as other types of construction.

2.3 Wood in Noncombustible Buildings

The *NBCC* requires that some buildings be of noncombustible construction (Chapter 4).

Noncombustible construction is defined as: a “type of construction in which a degree of fire safety is attained by the use of noncombustible materials for structural members and other building assemblies.”

Essentially, this type of construction requires the use of noncombustible materials for the structure and certain assemblies.

Noncombustible is defined as: “meaning a material meets the acceptance criteria of CAN4-S114, *Determination of Non-Combustibility in Building Materials*.”

Noncombustible construction is, however, something of a misnomer: it does not exclude the use of combustible materials but rather, it limits their use. Some combustible materials can be used since it is neither economical nor practical to construct a building entirely out of noncombustible materials.

The allowance of combustible components is also partly due to the severe test for determining the noncombustibility of materials which does not distinguish between degrees of combustibility. Based on this test, gypsum wallboard would not be permitted in noncombustible construction since it fails to meet one of the criteria (flaming) and is therefore considered a combustible product.

Many combustible materials are allowed in concealed spaces and in

areas where, in a fire, they are not likely to seriously affect other fire safety features of the building. Restrictions are based on flame-spread and the amount of smoke generated (for example, foamed plastic insulation).

The flame-spread rating and smoke developed classification are comparative indices of materials. These are explained in Chapter 3 and further detailed in Chapter 6.

Wood is probably the most prevalent combustible material used in noncombustible buildings.

It may be used as furring strips or fascia and canopies, cant strips, roof curbs, firestopping, roof sheathing and coverings, millwork, cabinets, counters, window sash, doors, flooring, studs and even as wall finishes.

Its use in certain types of buildings such as tall buildings is slightly more limited in areas such as exits, corridors and lobbies, but even there, fire-retardant treatments can be used to meet *NBCC* requirements.

3.2.2.16. In sprinklered noncombustible buildings not more than 2 storeys in height, entire roof assemblies and the roof supports can be heavy timber construction. Fire loss experience has shown, even in unsprinklered buildings, that heavy timber construction is superior to noncombustible roof assemblies not having any fire-resistance rating.

In other noncombustible buildings, heavy timber construction, including the floor assemblies, is permitted without the building being sprinklered.



TABLE 2.2

Permitted uses of heavy timber construction in or as an alternative to noncombustible buildings

OCCUPANCY	HEIGHT	SPRINKLERED ¹	PERMITTED USES
Group A, Div 1 3.2.2.21.	1 Storey	Yes	Roof, floors and supports
Group A, Div 3 3.2.2.30.	2 Storeys	No	Roof and its supports
Group A, Div 3 3.2.2.31.	2 Storeys	Yes	Roof and its supports, arches supporting floors
Group A, Div 4 3.2.2.35.	Not regulated	No	Roof and its supports
Group F, Div 1 3.2.2.64.	3 Storeys	Yes	Roof, floors and supports
Group F, Div 3 3.2.2.80.	1 Storey	No	Roof, floors and supports

Note 1 Article 3.2.2.16. permits roof assemblies and the supports to be heavy timber construction in any sprinklered noncombustible building not more than two storeys in height.

Examples of permitted heavy timber construction uses in or, as an alternative to, noncombustible buildings are shown in Table 2.2.

Combustible materials which can be used in buildings of noncombustible construction are listed in Subsection 3.1.5. of the *NBCC*.

A task group has been formed within the CCBFC Standing Committee on Fire Protection to look at introducing the concept of “degrees of combustibility” into the *NBCC*. Using this method, the heat release rate of combustible products and materials will be used to rank them and determine any limits on their use, structurally or otherwise. This is discussed further in Chapter 3.

The following brief description of other uses of wood permitted in noncombustible buildings gives some indication of its versatility.

WOOD FURRING

3.1.5.6. Wood is particularly useful as a nailing base for different types of cladding and interior finishes. The *NBCC* allows wood furring strips to be used to attach interior finishes such as gypsum wallboard, provided:

- the strips are fastened to noncombustible backing or recessed into it
- the concealed space created by the wood elements is not more than 50mm thick
- the concealed space created by the wood elements is firestopped

Experience has shown that a lack of oxygen in these shallow concealed spaces prevents rapid development of fire.

3.1.5.3.(4) The *NBCC* also permits wood nailer strips on parapets, provided the facings and any roof membrane covering the facings are protected by sheet metal. This relaxation of earlier regulations was introduced because it was considered that a nailing base such as plywood or oriented strandboard (OSB) does not constitute an undue fire hazard.

FIRE STOP

3.1.5.2.(1)(d) Wood is generally used for firestops in combustible construction, but it may also be used in noncombustible assemblies. However it must meet the criteria for firestops when the assembly is subject to the standard fire test used to determine fire resistance described in Chapter 4.

3.1.5.3.(2) Wood is also permitted as a firestop material for dividing concealed spaces into compartments in roofs of permitted combustible construction. Firestops are described in Chapter 5.

ROOFS

3.1.5.3.(2)&(3) In the installation of roofing, wood cant strips, roof curbs, nailing strips are permitted in noncombustible construction. Roof sheathing and sheathing supports of wood are also permitted provided:

- they are installed above a concrete deck
- the concealed space does not extend more than 1m above the deck
- the concealed roof space is compartmented by firestops

- openings through the concrete deck are located in noncombustible shafts
- parapets are provided at the deck perimeter extending at least 150mm above the sheathing

The noncombustible parapets and shafts are required to prevent roof materials igniting from flames projecting from openings in the building face or roof deck.

3.1.5.3.(1) The *NBCC* also requires buildings that must be of noncombustible construction to have roof coverings of Class A, B or C (Chapter 6). In such cases, the use of fire-retardant treated wood shakes and shingles on sloped roofs is allowed.

WINDOW SASHES AND FRAMES

3.1.5.4.(5) Wood sashes and frames are permitted provided each window is separated from adjacent windows by noncombustible construction and meets a limit on the aggregate area of openings in the outside face of a fire compartment.

Glass typically fails early during a fire, allowing flames to project from the opening and thereby creating serious potential for the vertical spread of fire. The requirement for noncombustible construction between windows is intended to limit fire spread along combustible frames closely set into the outside face of the building.



COMBUSTIBLE CLADDING AND FASCIAS

3.1.5.5. The 1995 *NBCC* further relaxed the rules on the use of combustible claddings and supporting assemblies on certain types of noncombustible buildings.

Specifically, the use of wall assemblies containing both combustible cladding elements and non-load-bearing wood framing members is allowed (Figures 2.8 & 2.9).

These wall assemblies can be used as in-fill or panel type walls between structural elements, or

FIGURE 2.8

Wood frame exterior wall in noncombustible construction

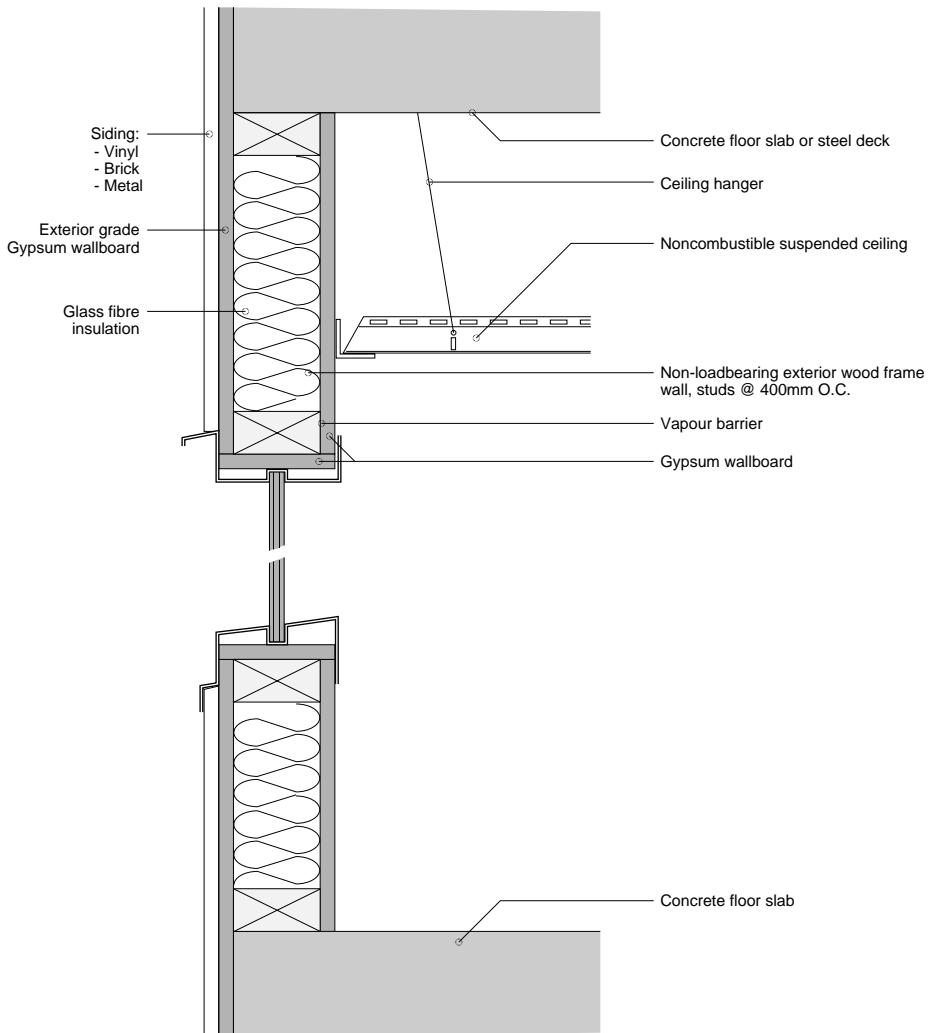

Notes:

1. Example of wood frame non-loadbearing exterior wall section permitted in buildings required to be of noncombustible construction.
2. Siding and exterior grade gypsum wall board can be replaced with exterior grade fire retardant treated wood siding when phenolic foam insulation is used in the stud cavities.

be attached directly to a loadbearing noncombustible structural system. This applies in unsprinklered buildings up to three storeys and sprinklered buildings of any height.

The wall assembly must satisfy the criteria of a test that determines its degree of flammability and the interior surfaces of the wall assembly must be protected by a thermal barrier (for example, 12.7mm gypsum wallboard) to limit the impact of an interior fire on the wall assembly.

These requirements stem from full-scale IRC tests that indicated that certain wall assemblies con-

taining combustible elements do not promote fire spread beyond a limited distance.

3.1.5.5.(1) The ULC test standard, CAN/ULC-S134, *Standard Method of Fire Test of Exterior Wall Assemblies* is referenced in the *NBCC*. Each assembly must be tested in accordance with this standard to confirm compliance with fire spread and heat flux limitations specified in the *NBCC*.

3.1.5.5.(1) & 3.2.3.7.(9)

Combustible cladding assemblies that meet the requirements of the test are permitted to be used in noncombustible construction

FIGURE 2.9

Wood stud framing in exterior wall of noncombustible building



where spatial separation requirements in Subsection 3.2.3. of the *NBCC* permit noncombustible cladding, and, more than 10% of unprotected openings is allowed.

Combustible cladding systems are excluded for cases where the unprotected openings cannot exceed 10% because the fire research used to develop these requirements did not consider the impact of the combustible cladding assemblies on fire spread to adjacent buildings.

3.1.5.5.(5) Fire-retardant treated wood (FRTW) decorative cladding is permitted on first floor canopy fascias. In this case, the wood must undergo accelerated weathering

before testing to establish the flame-spread rating. An FSR of 25 or less is required.

MILLWORK

3.1.5.7.(1) Wood millwork such as interior trim, doors and door frames, show windows and frames, aprons and backing, handrails, shelves, cabinets and counters are also permitted in noncombustible construction. Because these elements contribute minimally to the overall fire hazard it is not necessary to restrict their use.

FIGURE 2.10
Raised wood floor

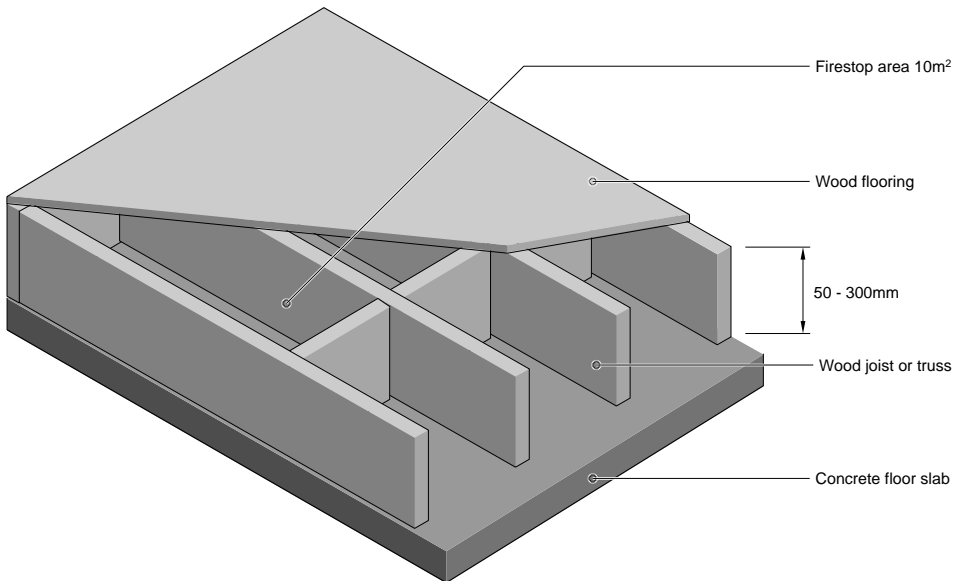

FLOORING ELEMENTS

3.1.5.8.(4) Combustible sub-flooring and finished flooring, such as wood strip or parquet is allowed in any noncombustible building, including high rises. Finished wood flooring is not a major concern. During a fire, the air layer close to the floor remains relatively cool in comparison with the hot air rising to the ceiling.

3.1.5.8.(2) Wood supports for combustible flooring are also permitted provided:

- they are at least 50mm but no more than 300mm high
- they are applied directly onto or are recessed into a noncombustible floor slab
- the concealed spaces are firestopped (Figure 2.10)

This allows the use of wood joists or wood trusses, the latter providing more flexibility for running building services within the space.

3.1.5.8.(1) Stages are normally fairly large and considerably higher than 300mm which creates a large concealed space. Because of this, wood stage flooring must be supported by noncombustible structural members.

WOOD PARTITIONS

Wood framing has many applications in partitions in both low rise and high rise buildings required to be of noncombustible construction. The framing can be located in most types of partitions, with or without a fire-resistance rating.

3.1.5.12.(1) Wood framing and sheathing is permitted in partitions, or alternatively, solid lumber partitions at least 38mm thick (seldom used) are permitted, provided:

- the partitions are not used in a care or detention occupancy
- the area of the fire compartment, if not sprinklered, is limited to 600m² (unlimited in a floor area that is sprinklered)
- the partitions are not required by the Code to be fire separations

3.1.5.12.(2) Alternatively, wood framing is permitted in partitions throughout floor areas, and can be used in most fire separations with no limits on compartment size or a need for sprinkler protection provided:

- the building is not more than three storeys in height
- the partitions are not used in a care or detention occupancy
- the partitions are not installed as enclosures for exits or vertical service spaces

3.1.5.12.(3) Similarly, as a final option, wood framing is permitted in buildings with no restriction on building height provided:

- the building is sprinklered
- the partitions are not used in a care or detention occupancy
- the partitions are not installed as enclosures for exits or vertical service spaces
- the partitions are not used as fire separations to enclose a mezzanine



These changes in the 1995 *NBCC* are based on the performance of fire rated wood stud partitions compared to steel stud partitions. This research showed similar performance for wood or steel stud assemblies.

The increase in the amount of combustible material permitted was not large compared to what had been permitted in previous editions of the *NBCC*. In many cases, the framing is protected and only burns later in a fire once all combustible contents have been consumed by which time the threat to life safety is not high.

The exclusion of the framing in care and detention occupancies and in applications around critical spaces such as shafts and exits are applied to keep the level of risk as low as practical in these applications.

STAIRS AND STORAGE LOCKERS

3.1.5.9. & 3.1.5.13 Stairs within a dwelling unit can be made of wood as can storage lockers in residential buildings. These are permitted as their use is not expected to present a significant fire hazard.

WOOD FINISHES

The use of interior finishes is mostly regulated by restrictions on their flame-spread rating. However, where finishes are used as protection for foamed plastic insulation, they are required to act as a thermal barrier (Chapter 6).

3.1.13.2. Wood finishes not exceeding 25mm in thickness and having a flame spread rating (FSR) of 150 or less may be used extensively in noncombustible buildings, not considered a high building. They may be used on walls both within and outside suites.

Some restrictions do apply in certain areas of a building. The area permitted to have a FSR of 150 or less is limited as follows:

- in exits – only 10% of total wall area
- in certain lobbies – only 25% of total wall area
- in vertical spaces – only 10% of total wall area

3.1.5.10.(3) The use of wood finishes on the ceilings in noncombustible buildings is much more restricted, but not totally excluded. In such cases, the flame spread rating must be 25 or less. In certain cases, ordinary wood finishes can also be used on 10% of the ceiling area of any one fire compartment, as well as on the ceilings of exits, lobbies and corridors.

3.1.4.4. & 3.1.5.10. Fire retardant treated wood (FRTW) must be used to meet the most restrictive limit of FSR 25. Consequently, it is permitted extensively throughout noncombustible buildings. The only restriction is that it cannot exceed 25 mm in thickness when used as a finish, except as wood battens on a ceiling, in which case no maximum thickness applies.

Fire retardant coatings applied to wood and other combustible materials do not meet the 25 flame-spread rating limits for walls or ceilings in noncombustible buildings, even if it has been tested and shown to provide a 25 flame-spread rating on a combustible substrate such as plywood.

3.1.5.10.(2) & (3) This is because the *NBCC* requirement for interior finishes in noncombustible buildings requires that the surface flame spread rating be applicable to any surface of the material that may be exposed by cutting through the material. Fire retardant treated wood is exempted from this requirement because the treatment is applied through pressure impregnation. Fire retardant coatings are not exempt because they are surface applied only.

3.1.13.6.(1) The FSR 75 flame limit for interior wall finishes in certain corridors does not exclude all wood products. Western red cedar, amabilis fir, western hemlock, western white pine and white or sitka spruce all have flame-spread ratings at or lower than 75. (Chapter 6)

3.1.13.6.(2) Corridors requiring FSR 75 include:

- public corridors in any occupancy
- corridors used by the public in assembly or care or detention occupancies
- corridors serving classrooms
- corridors serving sleeping rooms in care and detention occupancies

However, alternatively, the walls may be finished with wood products with a FRS of 150 or less on the lower half when the building is not sprinklered and the finish on the upper half has a FSR of 25.

3.1.13.6.(3) If these corridors are located in a sprinklered building, wood finishes having FSR 150 or less may be used to cover the entire wall surface.

3.1.13.7. In high buildings regulated by *NBCC* Subsection 3.2.6., wood finishes are permitted within suites or floor areas much as for other buildings of noncombustible construction. However, certain additional restrictions apply for:

- exit stairways
- corridors not within suites
- vestibules to exit stairs
- certain lobbies
- elevator cars
- service spaces and service rooms

These additional restrictions are waived, except for Group B occupancies and elevator cars, when the building is sprinklered (Chapters 6 and 10).

Table 6.3 in Chapter 6 summarizes the requirements for interior finishes including glazing and lighting elements.





3



The NBCC: Assumptions and Objectives

3.1	General Information	51
3.2	The NFPA Fire Safety Concepts Tree	53
3.3	Limiting Fire Growth	55
	The Noncombustibility Concept	57
	Flammability of Interior Finishes and Building Contents	58
3.4	Containing the Fire	61
	Fire Compartments	61
	Preventing Conflagrations	62
3.5	Suppress the Fire	65
3.6	Managing the Exposed	67
	Chapter Summary	68



3.1 General Information

North American building codes are based on certain fundamental principles and assumptions.

The North American approach to fire safety is predicated on the fact that fire-resistive design alone cannot ensure an acceptable level of safety. The contents of buildings, which are generally not subject to building regulations, can create a fire hazard far greater than the building itself.

A study performed by Consumer and Corporate Affairs Canada showed that the materials that are by far the most likely ignition sources are flammable or combustible liquids, such as gasoline or cooking oil.

The next most likely ignition source is furniture and furnishings. Although they account for fewer fires than flammable or combustible liquids, they are responsible for almost a quarter of the total number of fire deaths.

Because of this high hazard, some furniture and furnishings are regulated under the *Hazardous Products Act*. This Act limits the ignitability of the materials used in such items as mattresses, curtains and carpets.

Fire safety in buildings can be attained through different methods. The simplest is to adhere to strict design and construction requirements (prescriptive requirements).

These requirements state exactly which materials and construction must be used for every component of the building and thus offer very little flexibility. They can prove particularly difficult to adhere to in buildings with unusual characteristics and in the rehabilitation of older buildings.

Performance-based requirements set the level of performance that must be achieved by a system. A building system involves more than methods of assembly. All the interactive design elements that are intended to satisfy given fire safety objectives in a building make up the system.

Performance-based requirements offer a greater level of flexibility to the professionals involved in building design and construction. They do require, however, the measurement of the relative performance of various building components and design features. This can be difficult.

It is possible to evaluate the level of fire safety by considering the impact of a material or design solution on the overall system.

This process is called fire safety systems analysis, a methodical, step-by-step method for solving fire safety problems.

One such method or model, is the National Fire Protection Association (NFPA) Fire Safety Concepts Tree. It was designed by the NFPA Committee on Systems Concepts for Fire Protection in Structures. This model is now maintained and updated by the NFPA Standards Council.

The assumptions and objectives underlying the *NBCC* requirements are consistent with this model. The Fire Safety Concepts Tree will be used as a tool for illustrating the *NBCC* approach throughout the subsequent chapters.

For additional information, refer to the standard NFPA 550, *Guide to the Fire Safety Concepts Tree*, 1995 Edition, available from the National Fire Protection Association.

3.2 The NFPA Fire Safety Concepts Tree

The NFPA Fire Safety Concepts Tree, (Figure 3.1), shows the elements that should be considered for fire safety in buildings and the relationship between them.

The branches are connected by two types of gates:

- “or” gate means any branch will achieve the objective of the box above it
- “and” gate means all branches must be satisfied to ensure success

A lower level is not less important than the one above: it represents means for satisfying that higher level.

In theory, any branch will achieve the given objective if it is 100% effective. In reality, no one system may be relied upon to achieve

100% success. A fire safety system will necessarily rely on a combination of measures.

The Canadian Codes follow the model in principal but, to increase reliability, will require both branches of an “or” gate to be satisfied.

At the first level, overall fire safety objectives can be met either by preventing fire ignition or by managing the impact of a fire.

The conditions of the Prevent Fire Ignition branch essentially constitute the requirements of the *National Fire Code of Canada*. Though its strict enforcement can greatly reduce the possibility of ignition, it cannot provide assurances that a fire will never occur.

FIGURE 3.1

NFPA Fire Safety Concepts Tree

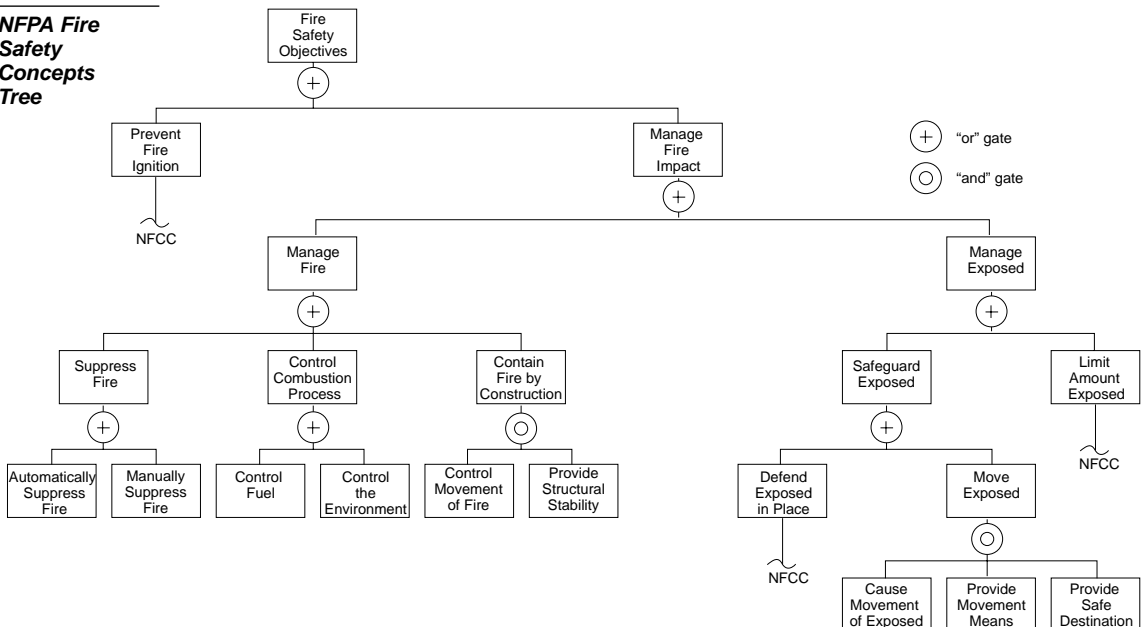

The *NBCC* follows the path of the Manage Fire Impact branch of the NFPA tree. It is assumed that a fire will occur and means must be provided to limit its consequences.

This is achieved by the next level of the tree by:

- managing the fire, or
- managing the exposed (the occupants)

The *NBCC* requirements are designed to satisfy both the Manage Fire and Manage Exposed branches. A number of measures in the next lower levels are required to achieve these objectives.

These measures are intended to protect the occupants and allow sufficient time for them to escape. The amount of time available will depend on:

- how quickly they are alerted (fire alarm and detection system)
- the rate at which the fire grows to hazardous levels (combustibility and flammability of building contents)
- the effectiveness of the room boundaries (walls, floor and ceiling) to resist the passage of heat, smoke and flames
- the ability of loadbearing elements to resist collapse (fire separation and fire resistance)

- the number, configuration and degree of protection of means of egress leading to the outside
- suppression of the fire

Obviously, the Suppress Fire branch must also be satisfied for the system to be effective. The *NBCC* contains requirements for automatic and manual suppression systems. Access for firefighters and provisions for their safety during suppression operations are also included.

Again these requirements are based on certain assumptions (availability of firefighting capabilities) which will be discussed later in this chapter (see also Chapter 9).

To summarize, the safety of the occupants depends on means to:

- limit fire growth
- contain the fire and provide structural stability
- alert occupants
- provide means of egress to a safe destination
- suppress the fire
- allow access and time for firefighting

A brief discussion of each of these objectives follows.

3.3 Limiting Fire Growth

Controlling the combustible content of a building (Control Combustion Process branch) plays a significant role in managing a fire.

Regardless of what material is first ignited, the fact remains that if a fire, once ignited, spreads and burns slowly, occupants can have sufficient time to escape.

This is why the *NBCC* regulates the flammability and combustibility of building materials. The flammability refers to the propensity of a material to be ignited and sustain burning, while the com-

combustibility concerns the rate at which it burns, if ignited.

The *NBCC* also makes a distinction between combustible and noncombustible construction.

It is important to understand that in the *NBCC*, the term “noncombustible construction” does not infer that building assemblies are made entirely from noncombustible materials.

Noncombustible construction is defined as: “a type of construction in which a degree of fire safety

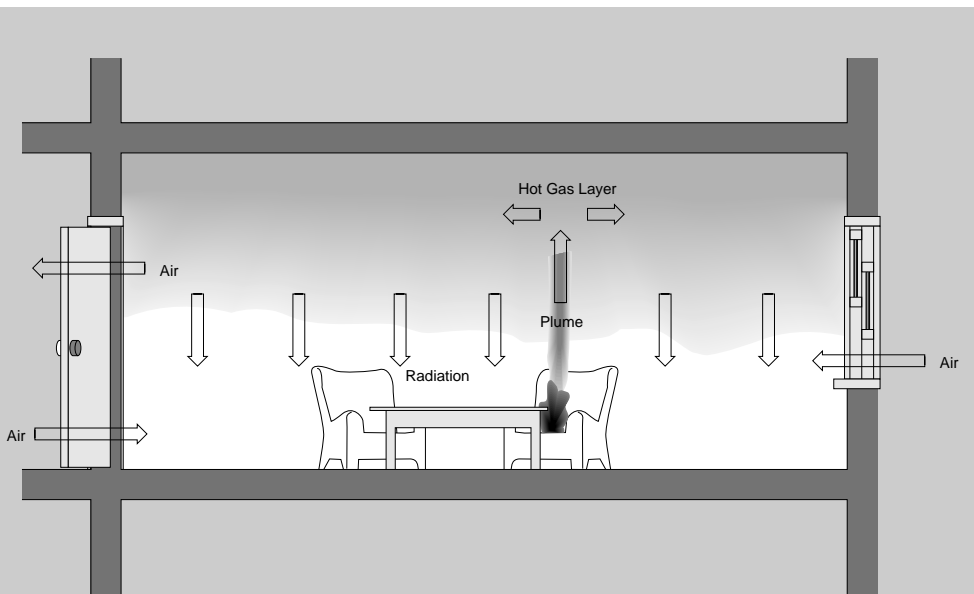

Fire Growth in a Room

To understand the measures outlined in this Chapter, it is useful to describe what happens when a fire occurs in a room. When an object is burning in an enclosed area, smoke rises to form a hot gas layer below the ceiling. These hot gases heat the ceiling and upper portion of the walls and thermal radiation from the hot layer, ceiling and walls begins to heat all the objects in the room. Given sufficient oxygen, this heating process can progress until all other combustible objects in the room reach their ignition temperature more or less simultaneously. At this point, every combustible object in the room will burst into flames, a state referred to as “flashover.” Flashover occurs when the temperature of the hot upper layer of air in the room reaches 500 to 600°C (needless to say, any occupants of the room would have perished long before this point).

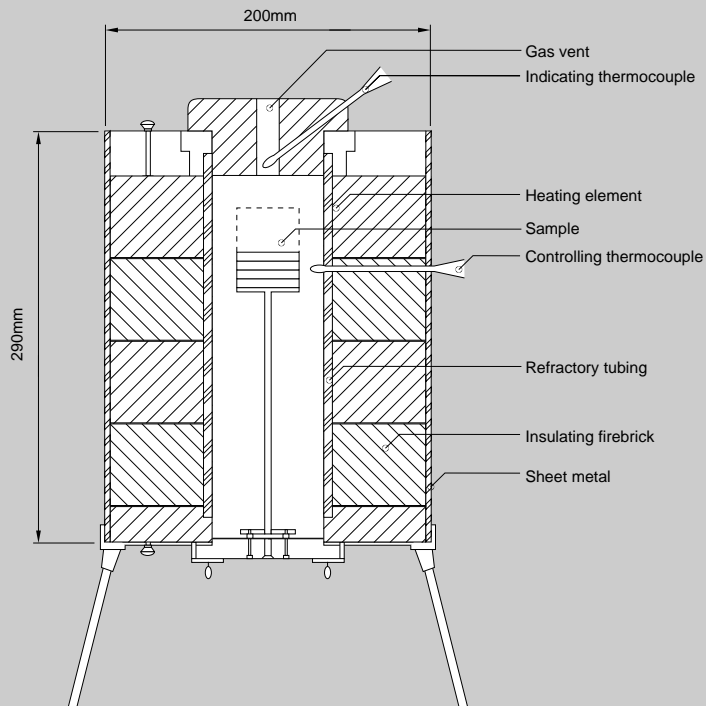

The Noncombustibility Test Furnace

The Noncombustibility Test

The noncombustibility of materials is determined by Underwriters' Laboratory of Canada (ULC) standard S-114, *Standard Method of Test for Determination of Noncombustibility of Materials*.

This test is conducted in a small, electrically heated furnace. Before the test, the furnace is heated to 750°C and stabilized to within 1°C for 15 minutes. The specimen is then placed in the sample holder and inserted into the furnace from below.

The test lasts 15 minutes, unless it is evident that the specimen has failed the test before that time. At least three specimens of a material must be tested.

Materials subjected to the test are considered noncombustible if:

- the mean of the maximum temperature rise (measured by an indicating thermocouple) for all specimens during the test does not exceed 36°C
- there is no flaming of any of the specimens after the first 30 seconds of the test
- the maximum loss of mass of any of the specimens during the test does not exceed 20%

is attained by the use of noncombustible materials for structural members and other building assemblies.”

As outlined in Chapter 2, various combustible materials and systems are permitted to be used in noncombustible construction. This is because the test which is used to determine the noncombustibility of materials is very different from that which determines the degree to which a construction assembly will withstand the effects of a fire (see Chapter 5 for an explanation of fire-resistance rating).

The noncombustibility test is only intended for the evaluation of basic building materials. The test does not apply to materials with a decorative coating or built-up laminations of different materials. (See “The Noncombustibility Test” at left.)

3.1.7.1. On the other hand, the test which determines fire resistance concerns the performance of an entire construction assembly exposed to the effects of a fire for a specified duration, regardless of whether it is constructed of combustible or noncombustible materials, or a combination of both.

THE NONCOMBUSTIBILITY CONCEPT

As can be seen from the description of the noncombustibility test in the insert, this is a severe pass-or-fail test.

A material is either found to be combustible or not: there is no measure of the degree of combustibility. Consequently, noncombustible materials are generally limited to materials such as: brick, concrete (without combustible aggregates), gypsum plaster, metals, glass and most stones.

FIGURE 3.2

Post-fire interior



Noncombustibility is an attribute which is considered to limit fire growth. If a material cannot be ignited, it will not contribute to the fire.

However, it is not the noncombustible items required for building construction but rather the building contents which contribute the most to fire growth. Hence, it can be argued that requirements for noncombustibility relate more to containing a fire than limiting fire growth.

The *NBCC* seldom requires specific noncombustible materials; it relies instead on the definition of noncombustible construction to infer that all materials used in the construction be noncombustible and then proceeds to allow combustible materials for various components.

3.1.5.5. In general, noncombustible materials are required for structural components and, with one exception (discussed in Chapter 4), for exterior cladding in buildings required to be of noncombustible construction.

3.1.5.2.(1)(b) They are also required to protect foamed plastic insulation. The most commonly used material for this purpose is gypsum wallboard which will not meet the noncombustibility criteria. Its use is permitted, nevertheless, because it has demonstrated satisfactory performance in fire conditions.

Finally, noncombustible materials can be used in certain instances (such as for ducts which penetrate a fire separation) to waive other requirements (such as fire dampers).

FLAMMABILITY OF INTERIOR FINISHES AND BUILDING CONTENTS

The burning of the building contents is recognized as contributing the most to fire growth in a room or space.

However, the development of a fire will also be influenced by exposed building materials such as wall and ceiling finishes, light fixtures and trim, and decorative materials in a room.

If walls and ceilings are involved in a fire at an early stage and burn too quickly, occupants could experience great difficulty in escaping the fire. This is why the *NBCC* imposes limits on the flame-spread potential of building materials.

3.1.12.1. Chapter 6 explains the test method used to determine the surface burning characteristics of materials. The results of the test are used to assign a relative index of the rate at which the material burns, called flame-spread rating (FSR). This rating is based on two benchmark materials, asbestos and red oak.

3.1.13. Generally, *NBCC* requirements on interior finishes are designed to become more restrictive as the space under consideration becomes more important to the evacuation of occupants.

Interior finish materials with a higher flammability will be permitted within individual suites to give designers more decorative flexibility.

Requirements become more restrictive in areas such as corridors and other egress routes, because build-

ing occupants must necessarily use these paths to move from the suites to the exits. If the interior finishes burn rapidly in these areas, occupants could find themselves unable to reach the exits.

Requirements for exits are the most restrictive since they act as collectors through which all occupants are funneled. Exits constitute the final link between the building and a safe destination; a fire cannot be allowed to develop within these areas. (Wood finishes can meet all levels of requirements).

A fire does not always originate within a room. It may start in a concealed ceiling space, or move from a room to that concealed space through an opening in the assembly that separates the room from the space.

Certain combustible materials are permitted to be used in the concealed spaces of buildings that are required to be of noncombustible construction. The *NBCC* places limits on the flame-spread potential of these materials. It also sets limits on the amount of smoke that can be generated from certain building materials. This is termed the smoke developed classification.

3.1.13.7. The smoke developed classification is particularly applicable to high buildings. These buildings have a tremendous potential for spreading smoke through the shafts that run the height of the building for stairs, elevators, pipes, ducts and other services. Temperature differentials between inside and outside air create a “stack effect” which causes shafts to act as chimneys, sucking air from the bottom of the building and pumping it into the higher floors.

The 1995 *NBCC* addresses this problem by requiring that sprinkler protection, one accepted method of smoke control, be provided for all high buildings. Design of tall buildings is discussed in Chapter 10.

Controlling the movement of smoke in tall buildings is very difficult. Even though sprinklering reduces the potential losses in highrise buildings, limits on smoke generation are still imposed on interior finishes.



3.4 Containing the Fire

Limiting the combustibility and flame-spread potential of materials satisfies the Control Combustion Process branch of the tree.

However, these measures will not ensure that a fire will not develop beyond flashover. Other means must be provided to contain the fire, hopefully within the area of origin (the Contain Fire by Construction branch). This is addressed through compartmentation, a concept used to control the hazards of a fully developed fire.

In a fully developed fire, the safety of the occupants within the room of fire origin is no longer an issue. As outlined in the description of a room fire, temperatures in the room will have reached the point where no one can be expected to survive.

The objective at this stage of a fire is to retard its spread so that the other occupants of the building have time to reach a place of safety. This allows firefighters

time to set up a staging area, perform rescue operations and suppress the fire.

FIRE COMPARTMENTS

Fire compartments are areas of a building ranging in size from a single room to an entire floor area. Physical barriers around these areas such as walls and ceilings are used to resist the spread of the fire for a period of time.

Fire compartment is defined as: “an enclosed space in a building that is separated from all other parts of the building by enclosing construction providing a fire separation having a required fire-resistance rating.”

3.1.8.1. Theoretically, a compartment is like a box designed to contain the fire within its boundaries. To be effective, these boundaries, called fire separations, must be continuous.

FIGURE 3.3

Fire safety requirements must be addressed early in the design stage



3.1.8.1.(2) However, openings in fire compartments are necessary to allow access and to provide for the passage of plumbing, electrical and other services. To maintain integrity, every opening in a fire separation must either be protected by a closure, (a door or shutter) or other mechanism which blocks the opening. For building services, the gap between the fire separation and the penetrating object must be filled with fire-resistant material.

Considering that it may take over an hour to evacuate a 30-storey office building, the importance of fire containment is apparent.

3.4.3. Stairways are normally designed to accommodate the evacuation of occupants on a floor-by-floor basis; therefore, the widths of exits are not cumulative, except where exits converge or serve an atrium (where all levels are expected to evacuate simultaneously).

Occupants on floors other than the floor of fire origin must be protected against the spread of fire for at least the amount of time required for the evacuation. This is why all floor/ceiling assemblies and stair enclosures are required to be built as fire separations. (See Chapter 8 for exit requirements.)

Fire separations and closures must normally have a known degree of resistance to fire (Chapter 5). The level of fire

resistance required for the assemblies will depend on:

- type of building
- building height
- occupancy

The occupancy will determine the severity of the fire which can be expected considering the use of the building (see Chapter 4).

PREVENTING CONFLAGRATIONS

The Control Movement of Fire branch of the NFPA Fire Safety Concepts Tree primarily looks at compartmentation inside the building.

3.2.3.1. However, it also extends to the spread of fire beyond the building of fire origin. In this respect, the *NBCC* includes provisions that are intended to prevent conflagrations by limiting the proximity of buildings and the number of openings in their exterior walls.

In a fully developed fire, the glass in windows will break. A burning building or compartment within a building will emit heat by radiation through these openings. This radiation could heat the exterior of an adjacent building and cause it to ignite, spreading the fire to another property.

The *NBCC* cannot impose restrictions on adjacent properties, it can only control the building for which a building permit is being requested.

The position and number of openings in the exterior walls of each building are regulated in relation to the boundaries of the lot on which the building is erected. This provides a fair set of rules for all.

Similar buildings located at equal distances from the lot line will be subject to the same restrictions regarding the construction of exterior walls and openings in those walls. (Figure 7.2, page 233)

FIGURE 3.4

Firefighter and the aftermath



3.5 Suppress the Fire

The *NBCC* contains requirements intended to satisfy the Suppress Fire branch of the tree. Some are aimed specifically at facilitating firefighting while others, such as the provision of manual (stand-pipe and hose), and automatic (sprinklers) fire protection systems, are associated with protecting occupants.

Significant changes were included in the 1995 *NBCC* regarding mandatory sprinkler protection for many buildings. The major factors considered in introducing the changes related largely to the level of risk expected in the buildings.

For example, loss experience showed the potential risk to be very high in buildings occupied for the care and detention of people. The *NBCC* now requires all Group B occupancies to be sprinklered. Similarly, highrise buildings present higher fire risk situations, and sprinkler protection is now required for all buildings more than six storeys in height.

3.2.3.1.(5) & 3.2.5. The *NBCC* assumes that firefighting resources are available in the event of a fire emergency, whether through a paid fire department or volunteers. The *NBCC* does not attempt to relate the size of a building to the capability of the municipal fire department.

It is the responsibility of each municipality to ensure that the size and height of buildings do not exceed its firefighting capabilities and available water supply. The minimum water supply required depends on a number of factors including whether or not the building is sprinklered.

3.2.5. Given these assumptions, the *NBCC* ensures that:

- firefighters have access to any storey that is within reach of aerial ladders
- firefighting vehicles can be positioned so as to deploy these ladders and other vehicles
- buildings are within reach of fire hydrants

Most fire departments in large cities have aerial ladders that will extend as high as six storeys, but truck ladders are available today which will extend to some 60m. In some buildings, such as high buildings, standpipes and hose systems are required so that the fire can be fought without having to carry hose lines all the way up to the fire floor.

Chapter 9 explains in greater detail some of the important elements in the *NBCC* to facilitate firefighting.



3.6 Managing the Exposed

Once a fire occurs, occupants of the building must evacuate as quickly as possible. For this to happen, they must be alerted to the danger.

The *NBCC* requires various means of fire detection and alarm, based on the severity of the threat to occupants. Chapter 8 describes these requirements.

In most buildings, detection devices are required to be linked to an alarm system because occupants, in their haste to evacuate, cannot be relied upon to phone the fire department or activate a manual pull station.

Delays in alerting occupants of danger have caused many deaths. In the Winecoff Hotel fire, for instance, with no automatic alarm system in the building, the initial alarm was delayed and the fire department was not notified until almost 30 minutes after the discovery of the fire (Chapter 1).

Many areas of a building, (lockers in residential buildings, rooms for building services, janitors' closets) are unoccupied most of the time. Automatic fire detection in such areas can save precious minutes.

3.4.2.1. One of the basic premises of the *NBCC* is that occupants should have a choice of two egress routes to vacate the building in case one of the exits is blocked by the fire.

A single exit may be permitted in cases where it is considered that the use of the space, the number of occupants and the distance which they must travel to reach the exit will not create an undue hazard. The number and location of exits depends on the number of occupants and the size of a floor area. (Chapter 8)

Exit facilities are not particularly interesting to designers and owners of buildings. They can constitute a fair amount of economically unviable space as well as a security problem; too many points of access and egress create an increased operational burden.

It is vital, however, to realize that the provision of well protected egress facilities can, in many cases, make the difference between life and death for occupants.





Chapter Summary

This Chapter examined the fire safety objectives of the *NBCC* which center on managing the impact of a fire in a building. The NFPA Fire Safety Concepts Tree was examined as a model to understand the concept.

The *NBCC* constitutes a set of minimum requirements. In some situations, the achievement of the fire safety objectives outlined in this Chapter may require measures beyond this minimum.

Experience has shown that fire safety is often misunderstood by designers. Both they and their clients often assume that by complying with the minimum requirements of building codes, fire safety will be achieved.

This is not always the case; neither the *NBCC* nor any other building code can anticipate every possible hazardous scenario.

Understanding the underlying objectives of the *NBCC* requirements is the first step in being able to assess the expected level of fire safety. The CCBFC is developing an “objective-based code” which will clearly define the objectives. This will make understanding and complying with the intent of the *NBCC* simpler for designers.

Designers must consult many sources of information which are available today to assess the fire safety of their designs. A number of firms specializing in fire protection engineering offer evaluation and design services to ensure that fire safety is achieved at a reasonable cost.



4



Construction Requirements

4.1	General Information	71
4.2	Classification of Buildings	73
	Building Size	73
	Major Occupancy	80
4.3	Determining Construction Requirements	83
	General	83
	Separation of Major Occupancies	85
	Fire-Resistance Rating of Supporting Assemblies	87
	Construction Requirement Options	87
4.4	Sprinkler Protection	91
	Changes in 1995 NBCC	91
4.5	Storeys Below Ground	95
	Chapter Summary	96
	Design Requirement Tables	97–127



4.1 General Information

Building is defined as: “any structure used or intended for supporting or sheltering any use or occupancy.”

This definition is fairly broad and can encompass practically any structure. Various attempts at defining the word building more precisely have been unsuccessful: as the definition becomes more accurate, it becomes more difficult to apply.

There are definite advantages in keeping the definition flexible for those instances where a structure presents a potential danger to the public but would not normally be considered a building. An oil refinery, for instance, does not have a floor area as defined in the *NBCC*, and so it would be impossible to apply exit requirements. On the other hand, there might be certain sections of the refinery, such as offices, where it would be desirable to apply the requirements of Part 3.

The *NBCC* only controls those elements which are part of the building construction (except for the contents of atrium spaces). The classification of buildings or parts of buildings according to their intended use accounts for:

- the quantity and type of combustible materials likely to be present (potential fire load)

- the number of persons likely to be exposed to the threat of fire
- the area of the building
- the height of the building

This classification is the starting point in determining which requirements apply to a particular building.

This chapter will explain the principles and rationale for the classification of buildings in the *NBCC* on the basis of occupancy and building size.

Classification dictates:

- the type of construction
- the level of protection
- the degree of protection between parts of a building that are used for different purposes

These are required to ensure the safety of the occupants and control the hazards to adjacent buildings.

The Design Requirement Tables included at the end of this chapter summarize the fire protection requirements of *NBCC* Subsection 3.2.2., which are based on building classification.



4.2 Classification of Buildings

The level of structural fire endurance and separation is based on the expected severity of the fire based on occupancy and the size and height of the building. The classification used by the *NBCC* also takes into account such factors as the mobility of the occupants and their state of alertness.

Obviously, the emergency evacuation of a theatre or hospital will be more difficult than that of an office building. *NBCC* Table 3.1.2.1. shows the various groups and divisions in which buildings can be classified and examples are provided in the *NBCC* Appendix.

The groups and divisions help to distinguish between various types of risk. The list of the groups and divisions and the reasoning

behind the classifications of occupancies are shown in Table 4.1.

As shown in Table 4.1, the important consideration in Groups A, B, C and D occupancies is protection of occupants from the hazards of the occupancies, while the primary concern in Groups E and F is containment of the fire within that space. For this reason, requirements for fire separations between these two groups of occupancies will be more stringent than between occupancies belonging to similar groups.

BUILDING SIZE

In order to determine the requirements for a building, both occupancy and building size are

FIGURE 4.1

Heavy timber skeleton of an arena



TABLE 4.1

Classification of buildings

Occupancy	Group	Division	Risk Factors	Examples
Assembly	A	1	Evacuation of considerable number of people, often from large spaces <ul style="list-style-type: none"> • poor lighting conditions can hinder evacuation • good lighting conditions • well lit • low fire loads • large open spaces where smoke can dissipate • open air assembly area • low risk of being trapped 	theatres
		2		schools
		3		arenas
		4		bleachers
Care and Detention	B	1	Acute evacuation problems because of restricted mobility of occupants <ul style="list-style-type: none"> • occupant movement is restricted by security measures • lack of occupant mobility • require safe area to permit two stage evacuation • need to contain fire to area of origin 	penitentiaries
		2		hospitals
Residential	C		<ul style="list-style-type: none"> • people may be sleeping when the need for emergency evacuation arises • significant delays in people becoming aware of a fire and evacuating the building • occupants must be protected while preparing to evacuate 	apartments hotels
Business	D		<ul style="list-style-type: none"> • occupants are fully alert • relatively low fire load • no major evacuation problems 	offices
Mercantile	E		<ul style="list-style-type: none"> • high combustible content which can result in severe fire with heavy smoke • occupants are aware • no unusual evacuation problems 	department stores
Industrial	F	1	<ul style="list-style-type: none"> • highly combustible and flammable or explosive substances • medium hazard, no explosive substances • low hazard, can still have high fire load 	distilleries
		2		factories
		3		warehouses

required. Building size is characterized by both area and height of a building. *NBCC* Subsection 3.2.2. uses these parameters to determine:

- the type of construction (combustible or noncombustible)
- the level of fire protection required for fire separations (fire-resistance rating)
- fire suppression requirements (automatic sprinklers)

Building Area

Building area is defined as: “the greatest horizontal area of a building above grade within the outside surface of exterior walls or within the outside surface of exterior walls and the centre line of firewalls.”

It is not calculated on a floor-by-floor basis, but as the total area in plan view, or footprint of the building (Figure 4.2).

It is important to note that firewalls may be used to reduce a building’s defined area. This is demonstrated in the following example.

Example 4.1

Occupancy: apartment – Group C
 Building area: 1500m²
 Building height: three storeys
 Building facing: two streets
 Sprinklers: none

Requirements – **3.2.2.44.** :

- the building must be of non-combustible construction
- one hour fire-resistance rating for floors and supporting assemblies

However, the building could be divided in half with a firewall. Since the *NBCC* considers each part of a building separated from the rest by firewalls as a separate building for the purposes of fire protection, we now have:

Building area: 750m²

Requirements could then be **3.2.2.47.** :

- the building could be of combustible construction
- 45 minute fire-resistance rating for floors and supporting assemblies

FIGURE 4.2
Determining building area

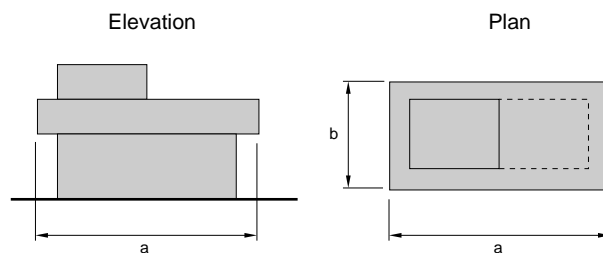

$$\text{Building Area} = a \times b$$



The economy of building with wood can easily offset the cost of the firewall.

Building Height

Determining building height is slightly more complex because it is related to the number of storeys above the first storey, which in turn is related to grade.

Grade is defined as: “the lowest of the average levels of finished ground adjoining each exterior wall of a building.”

For a building on a relatively flat lot, determining grade level is fairly simple. But it can become far more difficult for large buildings on irregular lots (Figure 4.3).

2.1.6.2. Where a residential building is set into a hillside it may be divided by one-hour vertical separations into compartments of up to three storeys. These are then treated as separate buildings to determine building height. However, the total building area is used to determine construction requirements (Figure 4.4). In addition, each section must be accessible to fire-fighters in conformance with the requirements for access for firefighting (Chapter 9).

Once the level of grade has been established, the first storey of the building is the storey with its floor level not more than 2m above that.

Building height is defined as: “the number of storeys between the roof and the floor of the first storey.”

FIGURE 4.3

Determining grade

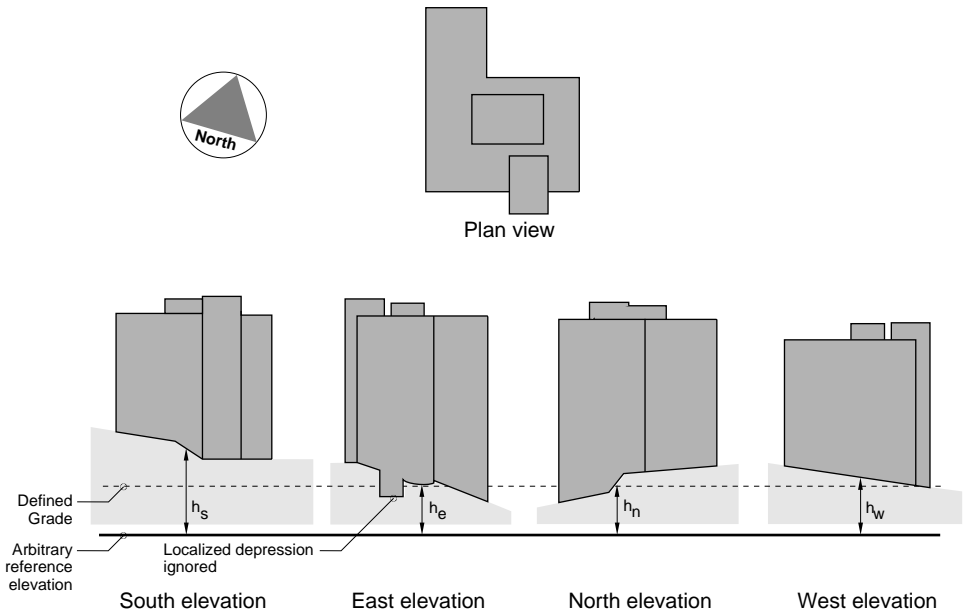

- Notes:
 1. $h_{s,e,n,w}$: average level of finished ground
 2. Grade = lowest of $h_{s,e,n,w}$

FIGURE 4.4

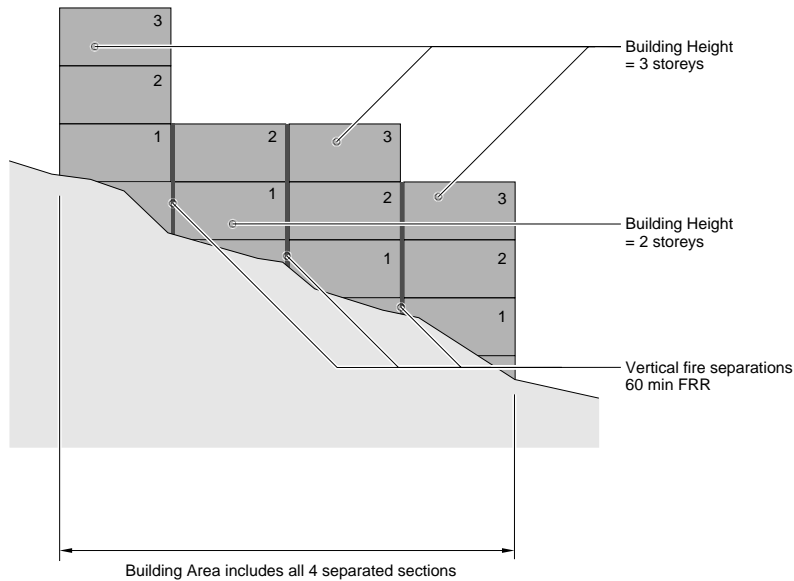
Determining number of storeys

Artificially raising the surrounding landscaping around the building to decrease the building height as defined by the building code is a controversial practice (Figure 4.5). This may make the difference between permitting combustible construction and requiring non-combustible construction for the building.

Exceptions for Building Height

3.2.1.1.(1) The calculation of building height excludes rooftop enclosures that house elevator machinery, air-conditioning and heating equipment and other services. Since these rooms are only accessible to service personnel they should not constitute a danger for occupants.

3.2.2.14.(2) The rooftop enclosure is not required to have a fire-resistance rating unless it exceeds one storey, in which case it must meet

the requirements for the rest of the building because its collapse could have repercussions for the top floors of the building.

3.2.1.1.(3) A mezzanine is not considered as a storey in building height if:

- its aggregate floor area is not more than 40% of the area of the floor area below
- it is used in an open floor area
- with the exception of libraries, it has no visual obstruction above or below it except for the first 1070mm above the floors (Figure 4.6)

Solid glazing typically seen in rinks or arena mezzanines is not considered a visual obstruction. Limits to visual obstructions ensure that occupants of the mezzanine are alerted to a life-threatening situation at the same time as the occupants of the floor area below.

FIGURE 4.5

Artificially raised grade



FIGURE 4.6

Mezzanines and building heights

Building would be considered as a three storey building if mezzanine not more than 40% of total floor area.

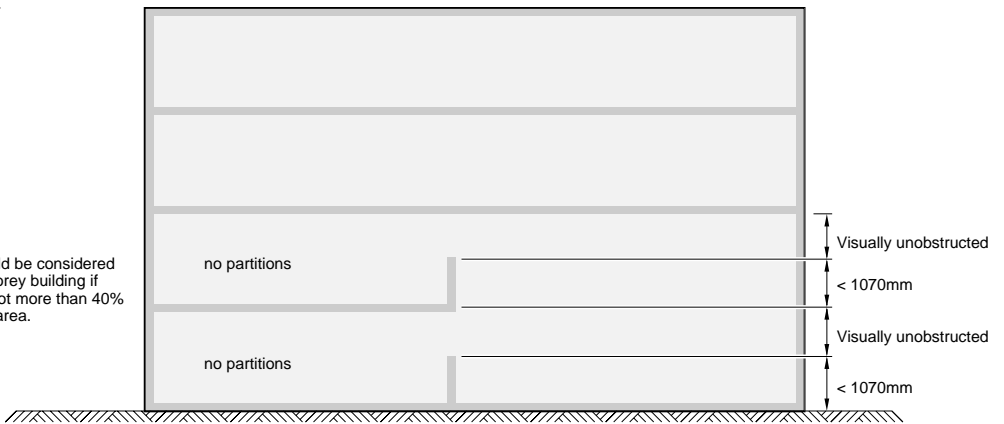

Building would be considered as a one storey building if mezzanine not more than 10% of total floor area.

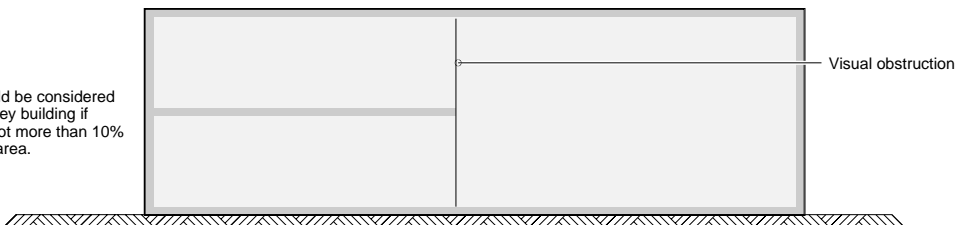

3.2.1.1.(4) Small mezzanines, up to 10% of the floor area below, are not considered as a storey in building height even if there are visual obstructions above or below it exceeding 1070mm. In such a small mezzanine, the number of occupants will be limited and evacuation should not be a problem.

Some authorities permit small areas up to 10% of the area of larger mezzanines to be enclosed, usually at the back of the mezzanine. This allows small office areas or washrooms on the mezzanine which, by their size, do not significantly increase the fire hazard and thereby do not warrant adding an additional storey to the building height.

3.2.1.1.(5) If there is more than one level of mezzanine, which is partially or wholly superimposed above another, the second and any additional mezzanines must be counted as a storey for determining building height.

This ensures that where multiple mezzanines are used, they are included in the determination of

building height for fire safety reasons (Figure 4.7). This applies only to mezzanines which are not already included as storeys in building height because of the area or visual limitations. It is not intended to apply to mezzanines which are essentially at the same level but separately located within the same storey.

Discretion must be used in applying these rules for multiple mezzanines and limits on enclosures or visual obstructions. Obviously, the more complicated the building design the greater the fire risk. The critical issues are how quickly the occupants will become aware of a fire and, once notified, how well they can safely evacuate the area.

3.2.8.2.(1) Most open mezzanines are limited to 500m² or less in area except in Group A, Divisions 1 and 3 major occupancies, not more than two storeys in height. In most other cases, the mezzanines must be enclosed by a vertical fire separation, which automatically makes the mezzanine a storey for building height.

FIGURE 4.7

Multiple levels of mezzanine

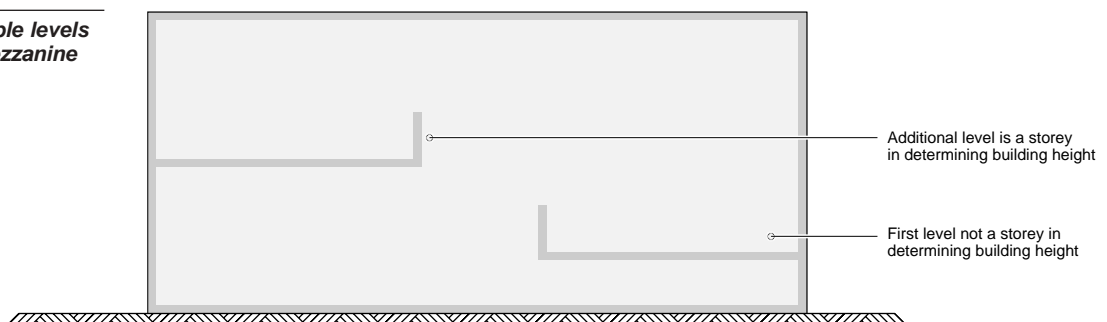

FIGURE 4.8

Office is a subsidiary occupancy to the warehouse



3.2.8. If not enclosed, the floor area containing the mezzanines is classified as an interconnected floor space. Depending on the size of the opening, interconnected floor spaces are limited to certain types of buildings. Additional fire protection requirements are applied to offset the hazard created by the lack of compartmentation (Chapter 5).

3.2.1.1.(2) Another exception to the calculation of building height is specific to arenas. The areas immediately under tiers of seats are not counted as a separate storey if the space is used only for ancillary purposes such as refreshment stands and dressing rooms. This is permitted because:

- these occupancies do not appreciably increase the hazard to life safety
- the interior is wide open
- the occupants are always alert and ready to evacuate

In many cases, if the arena were classified as two storeys in building height, depending on its area, it could be required to be of non-combustible construction because of these incidental occupancies.

MAJOR OCCUPANCY

The objective of classifying buildings and parts of buildings, as stated earlier, is to determine the level of protection required to ensure the safety of the occupants

given the risks associated with the activities carried on in a specific area.

The use of a space, a group of rooms, a floor or an entire building for the same purpose is referred to as an occupancy.

Occupancy is defined as “the use or intended use of a building or part thereof for the shelter or support of persons, animals or property.”

Each type of occupancy is subject to requirements concerning:

- structural fire endurance
- flame spread
- fire alarms
- exiting
- fire separation

It is also necessary to consider the relationship between various occupancies within a building because some constitute a greater fire and life hazard to others. This is where the often misunderstood concept of major occupancy is introduced.

Major occupancy is defined as: “the principal occupancy for which a building or part thereof is used or intended to be used and shall be deemed to include the subsidiary occupancies which are an integral part of the principal occupancy.”

The *NBCC* uses the concept of major occupancy for two reasons:

- To ensure that the risks associated with each occupancy are weighted against each other in the context of the entire building and not just the part of the

building under consideration. The most conservative set of requirements is used to design the building.

- To avoid having to classify certain uses within an occupancy that are deemed to be “subsidiary occupancies which form an integral part of the principal occupancy.”

For example, a school may contain, in addition to classrooms, such occupancies as offices, a gymnasium, an auditorium, a cafeteria and laboratories. All of these uses could be considered as related to the principal use of the building, which is education. In this case the major occupancy would be Group A, Division 2 and the different activities are considered to be part of that occupancy.

On the other hand, the auditorium might be used regularly for performances which are not necessarily associated with the normal activities of the school, and could be treated as a distinct major occupancy.

The dividing line between what constitutes a major occupancy and a subsidiary occupancy will not always be clear-cut; judgement must be exercised. It could be argued that shops within a hotel serve hotel guests and should therefore be considered a subsidiary mercantile occupancy. However, such shops also serve other customers and could be considered a major occupancy in their own right (Figure 4.9).



3.2.2.6. Generally, the *NBCC* requires that the entire building be constructed according to the rules of whichever major occupancy in the building warrants the most restrictive requirements.

3.2.2.7.(1) However, since buildings are usually designed so that each storey is a separate compartment, the *NBCC* states that where one major occupancy is entirely above another, each occupancy shall be designed to its own respective requirements. Minimum fire-resistance ratings for the floor assemblies between the storeys are specified.

The basic principle for determining how a building must be constructed is:

- classify each area of a building according to its principal use (which then becomes the major occupancy for that part)
- determine the type of construction and the necessary level of protection by considering the area and height of the entire building and the number of streets the building faces

This principle is illustrated by examples in the following section.

FIGURE 4.9

Multiple occupancy

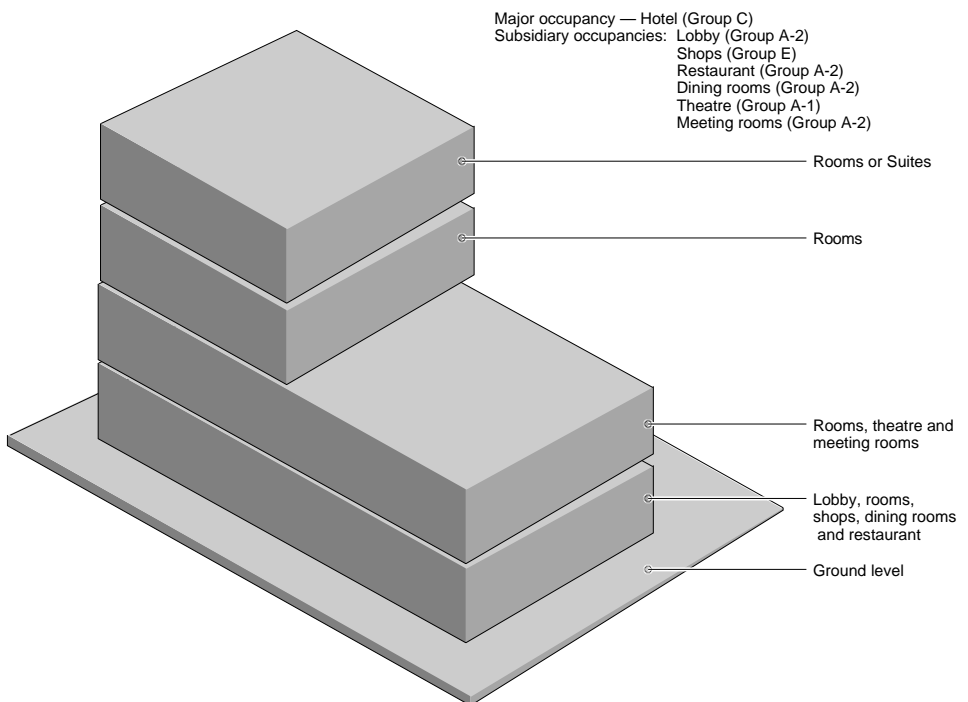

4.3 Determining Construction Requirements

GENERAL

Example 4.2

Building height: six-storey

Building area: 5000 m²

Major Occupancy: Group C, residential.

Construction and fire protection requirements — **3.2.2.43.**

- automatic sprinklers
- noncombustible construction
- all floor assemblies must be fire separations with a fire-resistance rating (FRR) of at least one hour
- mezzanines must have a FRR of at least one hour
- load bearing walls and columns must have a FRR of at least one hour

These minimum requirements are intended to ensure that all occupants have time to reach the exits and evacuate the building; in this case, at least one-hour fire-resistance for floors and supporting assemblies. The floors are required to be constructed as fire separations to create fire compartments.

Example 4.3

Now consider the introduction of a number of shops (Group E) occupying most of the first storey of the building in Example 4.2.

Construction and fire protection requirements — **3.2.2.57. & 3.2.2.43.**

- automatic sprinklers
- noncombustible construction
- floor assemblies over the basement and first storey must be fire separations with a FRR of at least two hours

- for the other storeys, floor assemblies must be fire separations with a FRR of at least one hour
- mezzanines must have a FRR of at least one hour
- load bearing walls and columns must have a FRR at least equal to the supported structure

3.2.2.7. Even though an occupancy may be contained on a single storey, the level of fire protection and type of construction on that storey would impact the levels of safety provided for other floors. Thus the occupancy of greatest risk is considered as if occupying the entire building so that the minimum requirements will provide sufficient egress, fire-fighting provisions and all other safety factors commensurate with that higher risk.

3.2.2.5. In this example, the storey with shops will be treated as though it were part of a six-storey commercial building and the residential portion treated as part of a six-storey residential building.

It must be kept in mind that the fire-safety objectives are to ensure that occupants of the five upper floors have sufficient time to be alerted to the danger and evacuate the building, while permitting the fire department to undertake rescue and firefighting operations. An appropriate level of protection can only be achieved if the total height of the building is taken into account for each major occupancy, that is, by considering each floor or group of floors containing a major occupancy as part of a building of the same height and occupancy.



TABLE 4.2

*Fire separation
required
between major
occupancies*

Fire Separation hours

Group A Division 1 Assembly

1	Group A Division 2 Assembly										
1	1	Group A Division 3 Assembly									
1	1	1	Group A Division 4 Assembly								
2	2	2	2	Group B Division 1 Care and Detention							
2	2	2	2	2	Group B Division 2 Care and Detention						
1	1	1	1	2	2	Group C Residential					
1	1	1	1	2	2	1	Group D Business and Personal Services				
2	2	2	2	2	2	2 ³	NR	Group E Mercantile			
NP	NP	NP	NP	NP	NP	NP	3	3	Group F Division 1 Industrial		
2	2	2	2	2	2	2 ⁴	NR ²	NR ²	2	Group F Division 2 Industrial	
1 ¹	1 ¹	1 ¹	1 ¹	2	2	1 ¹	NR ¹	NR ¹	2	NR ¹	Group F Division 3 Industrial

Notes:

1. A 1-1/2 hour fire separation is required when the Group F, Division 3 occupancy is a storage garage (**3.3.5.6.**).
2. A 2 hour fire separation is required when the Group F, Division 2 occupancy is a repair garage (**3.3.5.5.**).
3. If the building containing a Group E major occupancy is not over three storeys

SEPARATION OF MAJOR OCCUPANCIES

But what about the floor separating the storey of shops from the storey of apartments?

3.2.2.7.(2) The requirements for multiple occupancy in the *NBCC* state that when a major occupancy is entirely located above another, the floor assembly between them must have the fire-resistance rating required for the lower occupancy.

3.1.3.1. The separation of major occupancies must also conform to the requirements of Table 4.2. This Table stipulates the minimum fire-resistance rating for fire separations between adjoining major occupancies. The most restrictive requirement will govern.

In this example, the floor above the first storey containing the shops will be required to have a fire-resistance rating of two hours based both on the FRR of two hours required for the mercantile occupancy and the two hour separation required by Table 4.2.

In the case of a two-storey building containing mercantile shops on the first storey and a restaurant on the second storey, a two-hour fire separation between the first and second storeys would be required (Table 4.2). Requirements based on the lower occupancy, a Group E occupancy in a two storey building, would only require a fire-resistance of 45 minutes but the more restrictive requirement of two hours will govern.

This is consistent with the approach to protect occupants in floors above from a more hazardous occupancy below.

Example 4.4 (Figure 4.10)

Occupancies:

- Storeys one and two: Storage Garage (Group F, Division 3)
- Storey three: Mercantile Shops (Group E)
- Storeys four to six: Offices (Group D)

Construction and fire protection requirements:

- non-combustible construction
- storeys one and two: one hour FRR, sprinklers . . . **3.2.2.75.**
- storey three: two hour FRR, sprinklers **3.2.2.57.**
- storey four to six: one hour FRR, no sprinklers . . . **3.2.2.50.**
- roof assembly one hour FRR **3.2.2.50.**
- separation F-3 and E: 1.5 hours FRR **3.3.5.6.**
- separation E and D: not required **3.1.3.1.**

By applying the rules for multiple occupancy buildings:

- the floor assembly between the first and second storeys has a fire-resistance rating of one hour
- the floor assembly between the second and third storeys separates two major occupancies and requires a 90 minute FRR (**3.3.5.6.**) as the most restrictive requirement governs
- the separation between the third storey (Group E) and the top storeys (Group D) is subject to



the requirements for the lower occupancy (two hours required for Group E, up to six storeys) even though Table 4.2 does not require any fire-resistance rating between those major occupancies.

- the remaining top storeys must have a FRR of one hour for the Group D occupancy
 - the top three storeys are not required to be sprinklered (**3.2.2.7.(1)**)
 - the first two storeys (Group F, Division 3) and the third storey (Group E) require sprinkler protection
- the roof assembly must have a FRR of one hour since the entire building is not sprinklered

Some adjoining major occupancies, such as D and E, do not have requirements for fire separation in Table 4.2. This Table applies to both vertical and horizontal separations and is not concerned with height. A fire separation between a shop and an office on the same floor is not required. This is because the danger to occupants is minimized by the fact that occupants in the office portion are likely fully alert and can respond rapidly to evacuate the fire floor.

FIGURE 4.10

Fire-resistance rating of supporting assemblies

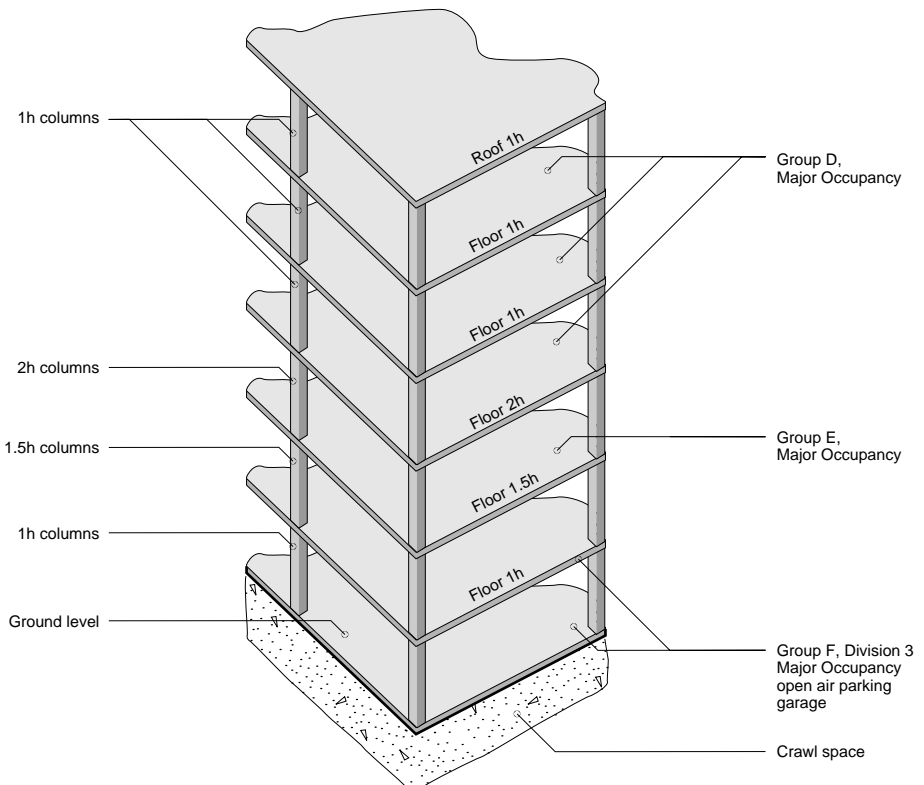

This is not necessarily the case when the occupancies are super-imposed, because it may take longer for the occupants to realize the danger and travel distances are increased. In this case the fire separation requirements of the lower occupancy will govern.

3.2.2.8. If the total area of a major occupancy in a particular Group or Division is not more than 10% of the floor area, it does not have to be considered as a major occupancy for the purposes of Subsection 3.2.2.. This means that the construction requirements do not have to be based on this occupancy and that the occupancy separation requirements in Table 4.2 need not apply.

This is because it would prove overly onerous in relation to the risks involved. This exception does not apply where the major occupancy is classified as Group F, Division 1 or 2, (Industrial, high or medium hazard), because of the significant inherent fire hazard.

FIRE-RESISTANCE RATING OF SUPPORTING ASSEMBLIES

3.1.7.5.(1) The *NBCC* requires in most cases that supporting assemblies for floors have a fire-resistance rating at least equal to that required for that floor assembly.

3.2.2.7.(1) However, it is not necessary to rate the supporting assemblies in a lower level occupancy on the basis of the fire protection requirements for the upper level.

The minimum fire performance required for the floor and its supporting assemblies depends on the expected fire severity on that level.

In our example shown in Figure 4.10, the columns supporting the floor assembly above the Group E occupancies must have a fire-resistance of two hours on that level only. The columns supporting the floor above the parking garage on the second storey, even if they are supporting the columns above on the third storey, are only required to have a fire-resistance rating of 90 minutes. Similarly, the columns supporting the floor assembly above the first storey are only required to have a fire-resistance rating of one hour.

3.1.7.5.(2) The same principle applies to service rooms intended to contain an occupancy considered to be a high hazard. The fire-resistance rating for the service room, required by Section 3.6, might exceed the requirements for the remainder of the floor area. Although the construction enclosing these rooms must have a high fire-resistance rating, it does not have to be supported by columns or walls having the same high fire-resistance. The high FRR requirement is intended to contain the fire to the floor area or portion of the floor area where it is located.

CONSTRUCTION REQUIREMENT OPTIONS:

The construction requirements of Subsection 3.2.2. are structured by:

- occupancy



- height and area
- whether or not the building is sprinklered
- if not sprinklered, the number of streets the building faces

The permitted maximum area of an unsprinklered building is influenced not only by its height, but also by the number of streets that a building faces. Generally, the area permitted when the building faces one street is increased by:

- 25% if it faces two streets
- 50% if it faces three streets

This accounts for the fact that firefighting is more effective if the fire department has direct access to a building face. This is particularly important to life safety. If a building faces more than one street, firefighters have more options in positioning truck ladders and undertaking rescue operations. Ensuring firefighters' access to a building is one of the important fire safety measures on which the *NBCC* is based (Chapter 9).

The 1995 *NBCC* no longer varies permitted areas of buildings with the number of streets faced for sprinklered buildings. This is as a result of a review of the requirements for sprinklers and fire safety measures. This review concluded that the level of safety of sprinklered buildings should permit all sprinklered buildings to have the maximum area previously assigned to a sprinklered building facing three streets, regardless of the number of streets faced.

3.2.4.9. To increase the reliability of automatic sprinkler installations, all sprinkler systems are required to be electrically supervised and have a signal automatically transmitted to the fire department.

For any given building, several construction alternatives may be available and the designer may choose the least restrictive.

Example 4.5

Occupancy: office building
(Group D)

Building Height: three storeys

Building Area: 4000m²

Building Facing: two streets

Option A: Group D, up to 3 Storeys, Sprinklered **3.2.2.54**

In this case the building can be:

- built entirely of wood-frame construction having a 45-minute fire-resistance rating for major assemblies except the roof assembly
- noncombustible construction with floors as fire separations but with no fire-resistance rating required
- heavy timber construction, except that roof deck and supports need not comply to minimum dimensions
- mixed construction incorporating heavy timber and unprotected noncombustible construction along with the 45-minute rated wood-frame construction.

Option B: Group D, up to 6 Storeys **3.2.2.50**

In this case the building can be:

- unsprinklered and
- noncombustible construction with a fire-resistance rating of one hour for floors, roof and supporting construction

Option C: Group D, Any Height, Any Area, Sprinklered **3.2.2.49**

In this case, the building would be required to be:

- noncombustible construction with a fire-resistance of two hours

Obviously, Option C would probably not be considered unless there were plans to enlarge the building in the near future, but the first two options are viable. The owner

would have to weigh the costs and benefits of providing:

- a) the sprinkler system and combustible construction with 45-minute fire-resistance ratings or
- b) providing noncombustible construction having one-hour fire-resistance rating.

The building could also be divided by a firewall into two separate buildings of equal area. This would create another option.

Option D: Group D, up to 3 Storeys **3.2.2.53**

Building area: 2000m² each

In this case, the buildings can be:

- unsprinklered
- same construction options as Option A



4.4 Sprinkler Protection

A complete review of the requirements for automatic sprinkler protection and other fire safety provisions was done for the 1995 *NBCC*. This review looked at the loss statistics for sprinklered and unsprinklered buildings and the level of safety in these buildings. As a result of this study, the 1995 *NBCC* makes sprinklers mandatory in the occupancies shown in Table 4.3

These requirements were based on the high reliability and increased life safety provided by electrically supervised sprinkler systems. During a fire, sprinklers systems can:

- reduce fire temperatures
- control a fire until the fire department can take over fire extinguishing operations
- in some instances, extinguish a fire entirely

CHANGES IN THE 1995 NBCC

The review also resulted in the reduction of certain fire safety requirements for sprinklered buildings. A sprinklered building is now only required to face one street. An automatic sprinkler system will put the water directly on the fire, thus reducing the need for fire-fighters to have access to all sides of the building.

Under the 1995 *NBCC*, a sprinklered building will have the height and area allowances that were assigned to sprinklered buildings facing three streets in the previous edition of the *NBCC*. This has resulted in an increase in allowed area of up to 50% for many types of sprinklered buildings (Figure 4.12).

For buildings permitted to be of combustible construction, some assembly, mercantile and industrial occupancies are permitted a

TABLE 4.3

Mandatory sprinklers in the 1995 NBCC

Occupancy	Group	Division	Sprinklers Required
Assembly Bldgs	A	1	All
Assembly Bldgs	A	2	All > 2 storeys or > 2400m ²
Assembly Bldgs	A	3	All > 2 storeys or > 6000m ²
Assembly Bldgs	A	4	All enclosed seating
Institutional (Detention)	B	1	All
Institutional (Care)	B	2	All
Residential	C	–	All > 3 storeys
Business	D	–	All > 6 storeys
Mercantile	E	–	All > 3 storeys or > 1500m ²
High Hazard Industrial	F	1	All > 1 storey or 800m ²
Med. Hazard Industrial	F	2	All > 3 storeys or > 1500m ²
Low Hazard Industrial	F	3	All > 6 storeys



three- to five-fold increase in area with sprinklers. In many other cases, building height may be increased instead of building area if sprinklers are provided.

Four-storey wood-frame construction for residential, mercantile and commercial buildings (Groups C, D and E) is now permitted. (Figure 4.11). Sprinkler protection must be provided along with one hour fire-resistance ratings (FRR) for all major assemblies, except for roof assemblies.

3.2.4.7. All sprinkler systems are now required to be monitored and electronically supervised. A supervised sprinkler system will

cause an alarm signal to be transmitted to the fire department, an independent central station or proprietary control centre. An alarm is sent when a sprinkler head is activated or when a situation occurs that will affect the operation of the system, such as the movement of a control valve or loss of pressure.

In previous editions of the *NBCC*, the FRR of the roof was waived if the sprinkler system was electronically supervised. The new requirement for electronic supervision of all automatic sprinkler systems has resulted in:

- fire-resistance ratings are no longer required for the roof

FIGURE 4.11

Four-storey wood-frame construction

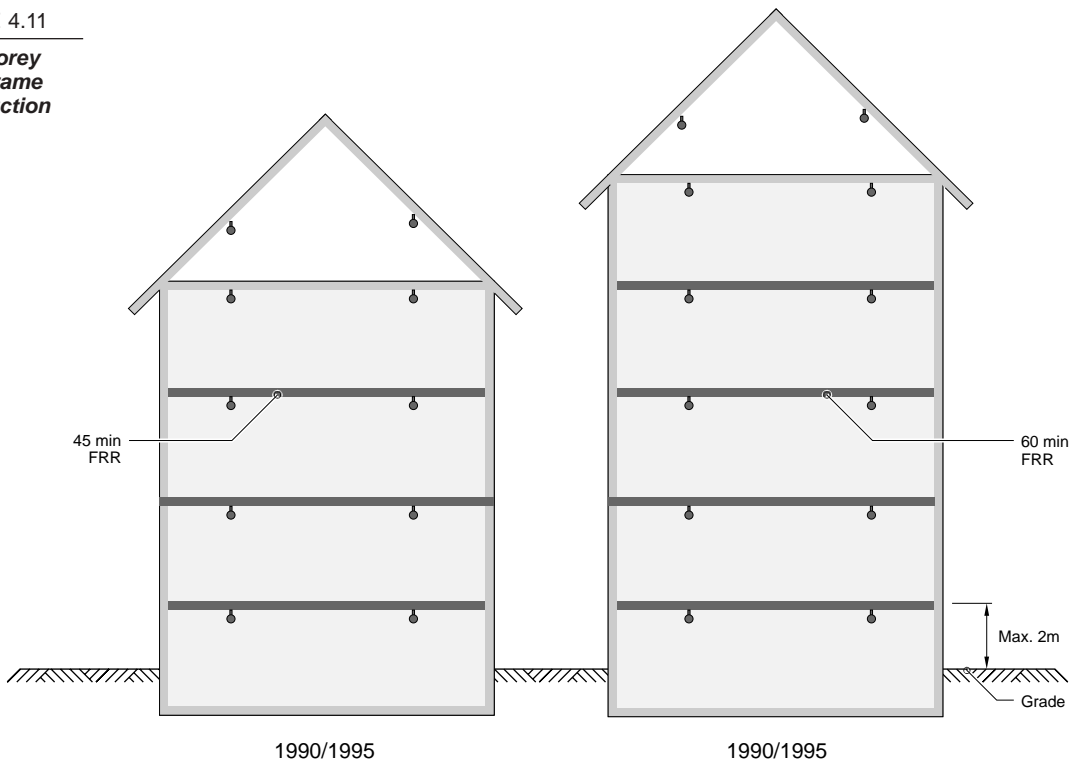

- Notes:
1. Group C Major Occupancy
 2. Buildings sprinklered (If residential sprinkler standard NFPA 13R is applied sprinklers are not required in attic space. See Section 9)
 3. Building assumed to face one street
 4. Maximum building area per floor is 1800m²

assemblies in sprinklered buildings

- heavy timber roofs are now permitted in all sprinklered noncombustible buildings of any area, up to two storeys in height **3.2.2.16**

Since a roof assembly does not require a rating, the supports do not have to be rated either. This results in greater design flexibility. As well, it removes the requirement for minimum sizes of heavy timber structural components and decks in buildings permitted to be of combustible construction.

Example 4.6

Determine the maximum area of the following:
 Occupancy: restaurant (Group A, Division 2)
 Building Height: one storey plus basement

Building Construction: unrated wood-frame construction

Facing: one street

- unsprinklered – maximum area = 400m² (**3.2.2.28**)
- sprinklered – maximum area = 1200m² (**3.2.2.27**)

Example 4.7

Determine the maximum height of the following:

Occupancy: mercantile (Group D)

Building Construction: wood-frame with 45 minute FRR

Facing: one street

Building Area: 1500m²

- unsprinklered – maximum height = 1 storey (**3.2.2.59**)
- sprinklered – maximum height = 3 storeys (**3.2.2.60**)

FIGURE 4.12

Impact of sprinkler changes: increased area

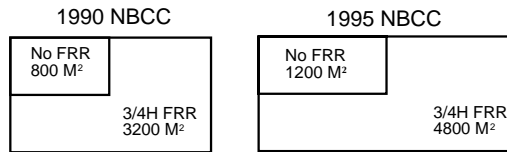

Group A, Div. 2; Facing 1 Street; Sprinklered

Impact of sprinkler changes: increased height

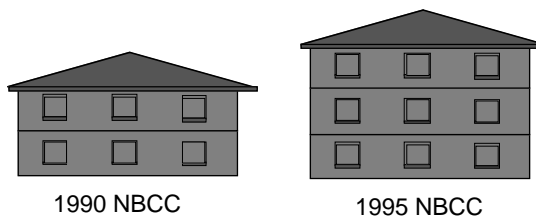

1990 NBCC 1995 NBCC
 Group C; Facing 1 Street; 1800m²; Sprinklered

4.5 Storeys Below Ground

The *NBCC* has specific requirements for underground storeys. Firefighting in basements is very difficult because:

- access and venting are complicated by the scarcity of openings to the outside
- firefighters must enter basements from the top, that is, through the hottest air layer
- firefighters are usually faced with heavy smoke conditions

3.2.1.5.(1) For these reasons, the *NBCC* requires that basements be:

- sprinklered or
- in unsprinklered buildings, divided into compartments 600m² or less by fire separations with the same fire-resistance rating as that required for the floor above

3.2.2.15.(2) Underground construction extending more than one storey below ground level must have all levels sprinklered. Floors and their supporting assemblies must have a fire-resistance rating of either two or three hours, depending on the occupancy.

3.2.2.15.(3) An exception to the requirements for sprinklers in basements applies when the storey immediately below the first storey contains only residential occupancies and the building is not otherwise required to be sprinklered. In this case, sprinklers are not required in that storey provided there are unobstructed access

openings for each 15m of wall length. This exception allows basement apartments commonly found in residential buildings which contain parking garage areas on lower sub-grade levels.

3.2.1.2. The *NBCC* also allows a basement used primarily as a parking garage to be considered as a separate building for the purpose of applying fire protection requirements, if:

- the garage is separated from the rest of the building by a concrete fire separation having a fire-resistance rating of two hours
- the portion of the basement walls extending above ground level also has a fire-resistance rating of two hours

This allows buildings that may be separated by firewalls or clear space to be treated as separate buildings in calculating building area even if there is a large underground parking garage underneath. In this way, the construction requirements of the above ground buildings will not be affected by the area of the parking garage. The above ground portions can often be separated to permit wood frame construction.

Crawl spaces usually have a more limited use than basements because of their size. Requirements for crawl spaces are therefore more lenient because they are assumed not to present a fire hazard.



3.2.2.9.(1) A crawl space is considered a basement if it is:

- more than 1.8m high
- used for any occupancy
- used for passage of flue pipes, or
- used as a plenum in combustible construction

In these instances, the requirements for basements, as outlined above, would apply.

3.1.11.6.(1). Unsprinklered crawl spaces not classified as basements must be divided by firestopping in compartments of not more than 600m² with no dimension greater than 30m.

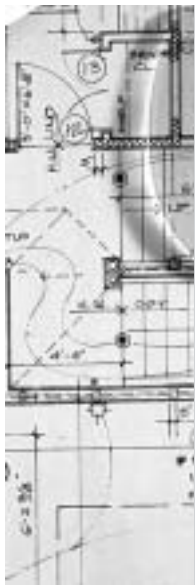

Chapter Summary

This Chapter has explained the classification of buildings and parts of buildings, how building size is calculated and how construction requirements are determined. It has also described the use of fire separations to achieve compartmentation within and between major occupancies, and some specific requirements relating to basements and roofs.

Building classification is also relevant to requirements for structural fire protection, flame-spread limitations, fire detection and alarms, exits and safety, as described in Chapters 5 through 9.

Design Requirement Tables

USE OF DESIGN REQUIREMENT TABLES

The fire protection requirements in Subsection 3.2.2. of the *NBCC* are summarized in the Design Requirement Tables at the end of this Chapter.

Each Table covers a major occupancy group (1) and lists examples of occupancies included within the group (2). Each column represents the construction requirements as stated in the referenced *NBCC* Articles (3) that pertain to the major occupancy and building height. As mentioned above, more than one Article can apply to a particular situation: the least restrictive is permitted to be used.

The tables are particularly useful because each construction requirement is identified by a symbol (4) which indicates one of the four construction types permitted as follows:

- Noncombustible construction
- Heavy timber construction, noncombustible construction or a combination
- Wood-frame construction with required fire performance characteristics, heavy timber construction, noncombustible construction or any combination
- Wood-frame construction or any other building system without special fire performance characteristics

MAXIMUM BUILDING HEIGHT, STOREYS		1		2		3	
		1	2	1	2	3	
MAXIMUM BUILDING AREA m ²	Unsprinklered	3.2.2.55.		3.2.2.53.		3.2.2.54.	
	facing 1 street	1000	800	4800	2400	1600	
	facing 2 streets	1250	1000	6000	3000	2000	
	facing 3 streets	1500	1200	7200	3600	2400	
	Sprinklered	3.2.2.56.		3.2.2.54.		3.2.2.54.	
		3000	2400	14400	7200	4800	
CONSTRUCTION REQUIREMENTS	Basements	○ Subdivided by 45-minute fire separations into areas not exceeding 600m ² , unless sprinklered.		○ Subdivided by 45-minute fire separations into areas not exceeding 600m ² , unless sprinklered.		○ Subdivided by 45-minute fire separations into areas not exceeding 600m ² , unless sprinklered.	
	Loadbearing Walls, Columns, Beams, Arches	○ Loadbearing elements supporting assemblies required to have a fire-resistance rating must have a 45-minute fire-resistance rating or be of unrated noncombustible or combination except that fire separation floor over basements must be supported by a 45-minute rated assembly.		○ Loadbearing elements supporting assemblies required to have a fire-resistance rating must have a 45-minute fire-resistance rating or be of unrated noncombustible or combination except that fire separation floor over basements must be supported by a 45-minute rated assembly.		○ Loadbearing elements supporting assemblies required to have a fire-resistance rating must have a 45-minute fire-resistance rating or be of unrated noncombustible or combination except that fire separation floor over basements must be supported by a 45-minute rated assembly.	

1

D
Business and Personal Services

Group D

Banks, Barber Shops, Offices and Radio Stations

2

3

4

CONSTRUCTION TYPES IN TABLES

● Noncombustible construction

The building must be constructed of noncombustible materials except as permitted in *NBCC* Subsection 3.1.5.

Use of wood is limited but not prohibited in noncombustible construction. The following wood use is allowed:

- wood nailing elements on non-combustible backing to attach wall and ceiling finishes
- wood millwork such as trim, windows, doors and frames allowed
- wood nailing strips or members up to 300 mm high as finished floor support
- wood stage flooring if supported by noncombustible construction
- wood flooring;
- wood framing and solid lumber partitions under specific conditions
- lumber and plywood wall panelling
- FRT plywood and lumber ceilings
- wood studs and FRT plywood in nonloadbearing exterior wall sections
- heavy timber roof assembly for buildings up to 2 storeys in height

◐ Heavy timber construction, noncombustible construction or a combination

The building can be constructed using noncombustible materials with the same exceptions as the previous category or heavy timber construction sized to meet 45-minute fire-resistance rating.

The following construction is permitted:

- floor decks can be tongue and groove plank, splined plank or spiked plank on edges
- roof decks can be tongue and groove plywood or plank, splined plank or laminated plank on edges
- columns, beams, arches and trusses can be lumber or glue-laminated timber

◑ Wood-frame construction with required fire performance characteristics, heavy timber construction, noncombustible construction or any combination

The building can be:

- wood-frame construction with a required fire-resistance rating or
- heavy timber construction or
- noncombustible construction

○ Wood-frame construction or any other building system without special fire performance characteristics

Any building material can be used in this category and no fire performance characteristics are required.

DESIGN REQUIREMENT TABLES

Group A — Division 1

Theatres,
Television
Studios and
Opera Houses

A1
Assembly

MAXIMUM BUILDING HEIGHT, STOREYS		Unlimited
MAXIMUM BUILDING AREA m ²	Sprinklered	3.2.2.20. Unlimited.
CONSTRUCTION REQUIREMENTS	Basements	● Noncombustible construction.
	Floor Assemblies Above Basements	● 2-hour fire separation.
	Floor Assemblies Above Crawl Spaces	● Noncombustible construction.
	All Other Floor Assemblies	● 2-hour fire separation.
	Mezzanines	● 1-hour fire-resistance rating. ⁵
	Roof Assemblies	◐ Heavy timber in buildings up to two storeys or noncombustible construction. ⁶
	Loadbearing Walls, Columns, Beams, Arches	● Fire-resistance rating must equal that required for supported assembly. ⁶



Noncombustible construction.



Heavy timber construction, noncombustible construction or a combination.



Wood-frame construction with required fire performance characteristics, heavy timber construction, noncombustible construction or any combination.



Wood-frame construction or any other building system without special fire performance characteristics.

DESIGN REQUIREMENT TABLES

A1

Assembly

Group A — Division 1

continued

Theatres,
Television
Studios and
Opera Houses

MAXIMUM BUILDING HEIGHT, STOREYS		1	1
MAXIMUM BUILDING AREA m ²	Sprinklered	3.2.2.21. 600	3.2.2.22. Unlimited.
USE AND OCCUPANCY RESTRICTION		Occupant load of building not more than 600 persons. ^{2,4}	Occupant load of auditorium floor area not more than 300 persons. ^{2,3}
CONSTRUCTION REQUIREMENTS	Basements	<input checked="" type="radio"/> Heavy timber or noncombustible construction or a combination.	<input type="radio"/> No special requirements.
	Floor Assemblies Above Basements	<input checked="" type="radio"/> Heavy timber or 45-minute noncombustible fire separation.	<input checked="" type="radio"/> 45-minute fire separation.
	Floor Assemblies Above Crawl Spaces	<input checked="" type="radio"/> Heavy timber or noncombustible construction or a combination.	<input type="radio"/> No special requirements.
	All Other Floor Assemblies	<input checked="" type="radio"/> Heavy timber or 45-minute noncombustible fire separation. ¹	<input checked="" type="radio"/> 45-minute fire separation. ¹
	Mezzanines	<input checked="" type="radio"/> Heavy timber or noncombustible construction or a combination.	<input checked="" type="radio"/> 45-minute fire-resistance rating if of combustible construction.
	Roof Assemblies	<input checked="" type="radio"/> Heavy timber or noncombustible construction or a combination.	<input type="radio"/> No special requirements.
	Loadbearing Walls, Columns, Beams, Arches	<input checked="" type="radio"/> Heavy timber or noncombustible construction with a fire-resistance rating, not less than that required for the supported assembly.	<input checked="" type="radio"/> 45-minute fire-resistance rating, or unrated non-combustible or a combination thereof if supported assembly required to have a fire-resistance rating, except that rated floor separations must be supported by a 45-minute rated assembly.

 Noncombustible construction. Heavy timber construction, noncombustible construction or a combination. Wood-frame construction with required fire performance characteristics, heavy timber construction, noncombustible construction or any combination. Wood-frame construction or any other building system without special fire performance characteristics.

DESIGN REQUIREMENT TABLES

Group A — Division 2

Auditoria,
Churches and
Nonresidential
Schools

A2
Assembly

MAXIMUM BUILDING HEIGHT, STOREYS		Unlimited	6
MAXIMUM BUILDING AREA m ²	Sprinklered	3.2.2.23. Unlimited.	3.2.2.24. Unlimited.
	CONSTRUCTION REQUIREMENTS		
	Basements	● Noncombustible construction.	● Noncombustible construction.
	Floor Assemblies Above Basements	● 2-hour fire separation.	● 1-hour fire separation.
	Floor Assemblies Above Crawl Spaces	● Noncombustible construction.	● Noncombustible construction.
	All Other Floor Assemblies	● 2-hour fire separation.	● 1-hour fire separation.
	Mezzanines	● 1-hour fire-resistance rating. ⁵	● 1-hour fire-resistance rating. ⁵
	Roof Assemblies	◐ Heavy timber in buildings up to two storeys or noncombustible construction. ⁶	◐ Heavy timber in buildings up to two storeys or noncombustible construction. ⁶
	Loadbearing Walls, Columns, Beams, Arches	● Fire-resistance rating must equal that required for supported assembly. ⁶	● Fire-resistance rating must equal that required for supported assembly. ⁶



- Noncombustible construction.
- ◐ Heavy timber construction, noncombustible construction or a combination.

- ◐ Wood-frame construction with required fire performance characteristics, heavy timber construction, noncombustible construction or any combination.
- Wood-frame construction or any other building system without special fire performance characteristics.







DESIGN REQUIREMENT TABLES

A2
Assembly

Group A — Division 2

continued

Auditoria,
Churches and
Nonresidential
Schools

MAXIMUM BUILDING HEIGHT, STOREYS		1	2
MAXIMUM BUILDING AREA m ²	Unsprinklered	3.2.2.25.	
	facing 1 street	1600	800
	facing 2 streets	2000	1000
	facing 3 streets	2400	1200
	Sprinklered	3.2.2.26.	
		4800	2400
CONSTRUCTION REQUIREMENTS	Basements	 Subdivided by 45-minute fire separations into areas not exceeding 600m ² , unless sprinklered.	
	Floor Assemblies Above Basements	 45-minute fire separation.	
	Floor Assemblies Above Crawl Spaces	 No special requirements.	
	All Other Floor Assemblies	 45-minute fire separation if of combustible construction; unrated fire separation if of noncombustible construction. ¹	
	Mezzanines	 45-minute fire-resistance rating if of combustible construction or unrated noncombustible ⁵	
	Roof Assemblies	 45-minute fire-resistance rating if of combustible construction, waived for a 1-storey building with FRTW roof system if building area is not more than one-half values otherwise permitted; or unrated noncombustible construction. ⁷ No rating requirements if sprinklered.	
	Loadbearing Walls, Columns, Beams, Arches	 45-minute fire-resistance rating or unrated noncombustible or a combination thereof if supported assembly required to have a fire-resistance rating, except that a fire separation floor over basements must be supported by 45-minute rated assembly.	

 Noncombustible construction.

 Heavy timber construction, noncombustible construction or a combination.

 Wood-frame construction with required fire performance characteristics, heavy timber construction, noncombustible construction or any combination.

 Wood-frame construction or any other building system without special fire performance characteristics.

DESIGN REQUIREMENT TABLES

Group A — Division 2

continued

Auditoria,
Churches and
Nonresidential
Schools

A2
Assembly

MAXIMUM BUILDING HEIGHT, STOREYS		1	2
MAXIMUM BUILDING AREA m ²	Unsprinklered facing 1 street facing 2 streets facing 3 streets	3.2.2.28 ⁹ 400 500 600	Not Permitted.
	Sprinklered	3.2.2.27. 1200 with basement. 2400 without basement.	600
CONSTRUCTION REQUIREMENTS	Basements	<input type="radio"/> No special requirements.	
	Floor Assemblies Above Basements	<input checked="" type="radio"/> 45-minute fire separation.	
	Floor Assemblies Above Crawl Spaces	<input type="radio"/> No special requirements.	
	All Other Floor Assemblies	<input type="radio"/> No special requirements. ¹	
	Mezzanines	<input type="radio"/> No special requirements. ⁵	
	Roof Assemblies	<input type="radio"/> No special requirements.	
	Loadbearing Walls, Columns, Beams, Arches	<input checked="" type="radio"/> Fire-resistance rating must equal that required for supported assembly (only applies to floors over basements).	



Noncombustible construction.

Heavy timber construction, noncombustible construction or a combination.

Wood-frame construction with required fire performance characteristics, heavy timber construction, noncombustible construction or any combination.

Wood-frame construction or any other building system without special fire performance characteristics.

DESIGN REQUIREMENT TABLES

A3 Assembly

Group A — Division 3

Arenas, Rinks and Indoor Swimming Pools

MAXIMUM BUILDING HEIGHT, STOREYS		Unlimited	1	2
MAXIMUM BUILDING AREA m ²	Unsprinklered facing 1 street facing 2 streets facing 3 streets	Not permitted.	3.2.2.30. 4000 5000 6000	2000 2500 3000
	Sprinklered	3.2.2.29. Unlimited.	3.2.2.31. 12 000	6000
CONSTRUCTION REQUIREMENTS	Basements	● Noncombustible construction.	● Subdivided by 1-hour fire separations into areas not exceeding 600m ² , unless sprinklered.	
	Floor Assemblies Above Basements	● 2-hour fire separation.	● 1-hour fire separation.	
	Floor Assemblies Above Crawl Spaces	● Noncombustible construction.	● Noncombustible construction.	
	All Other Floor Assemblies	● 2-hour fire separation.	● 1-hour fire separation. ¹	
	Mezzanines	● 1-hour fire-resistance rating. ⁵	● 1-hour fire-resistance rating. ⁵	
	Roof Assemblies	◐ Heavy timber in buildings up to two storeys, or noncombustible construction. ⁶	◐ 45-minute fire-resistance rating, waived for heavy timber. No rating or other special requirements if sprinklered. ^{6,7}	
	Loadbearing Walls, Columns, Beams, Arches	● Fire-resistance rating must equal that required for supported assembly. ⁶	◐ Fire-resistance rating must equal that required for supported assembly, heavy timber structural members permitted within storey immediately below roof assembly.	

- Noncombustible construction.
- ◐ Heavy timber construction, noncombustible construction or a combination.

- ◐ Wood-frame construction with required fire performance characteristics, heavy timber construction, noncombustible construction or any combination.
- Wood-frame construction or any other building system without special fire performance characteristics.

DESIGN REQUIREMENT TABLES

Group A — Division 3

continued

Arenas, Rinks
and Indoor
Swimming
Pools

A3
Assembly

MAXIMUM BUILDING HEIGHT, STOREYS		1	1
MAXIMUM BUILDING AREA m ²	Unsprinklered facing 1 street facing 2 streets facing 3 streets	3.2.2.32 2400 3000 3600	3.2.2.34 1000 1250 1500
	Sprinklered	Not applicable.	3.2.2.33 7200
CONSTRUCTION REQUIREMENTS	Basements	☐ Subdivided by 45-minute fire separations into areas not exceeding 600m ² .	☐ Subdivided by 45-minute fire separations into areas not exceeding 600m ² unless sprinklered.
	Floor Assemblies Above Basements	☐ 45-minute fire separation.	☐ 45-minute fire separation.
	Floor Assemblies Above Crawl Spaces	○ No special requirements.	○ No special requirements.
	All Other Floor Assemblies	○ No special requirements. ¹	○ No special requirements. ¹
	Mezzanines	☐ 45-minute fire-resistance rating if of combustible construction, or unrated noncombustible construction. ⁵	○ No special requirements. ⁵
	Roof Assemblies	☐ 45-minute fire-resistance rating if of combustible construction, waived if building area is not more than one-half values otherwise permitted and FRTW roof system used, or unrated noncombustible construction. ⁷	○ No special requirements.
	Loadbearing Walls, Columns, Beams, Arches	☐ 45-minute fire-resistance rating or unrated noncombustible or a combination thereof if supported assembly required to have a fire-resistance rating, except that a fire separation floor over basements must be supported by a 45-minute rated assembly.	☐ Fire separation floor over basement must be supported by a 45-minute rated assembly.



Noncombustible construction.



Heavy timber construction, noncombustible construction or a combination.



Wood-frame construction with required fire performance characteristics, heavy timber construction, noncombustible construction or any combination.



Wood-frame construction or any other building system without special fire performance characteristics.



DESIGN REQUIREMENT TABLES

A4

Assembly

Group A — Division 4Bleachers,
Grandstands
and Stadia

MAXIMUM BUILDING HEIGHT, STOREYS		Not regulated	
MAXIMUM BUILDING AREA m ²	Unsprinklered or Sprinklered ¹⁰	3.2.2.35.(3) Occupant load less than 1500 persons; structure has limiting distance of at least 6m.	3.2.2.35 Unlimited.
CONSTRUCTION REQUIREMENTS	Basements	Not applicable.	Not applicable.
	Floor Assemblies Above Basements	Not applicable.	Not applicable.
	Floor Assemblies Above Crawl Spaces	Not applicable.	Not applicable.
	All Other Floor Assemblies	○ No special requirements.	● Noncombustible construction.
	Mezzanines	Not applicable.	Not applicable.
	Roof Assemblies	○ No special requirements.	◐ Heavy timber or unrated noncombustible construction.
	Loadbearing Walls, Columns, Beams, Arches	○ No special requirements.	◐ Noncombustible construction; heavy timber roof assembly may be supported by heavy timber structural members.



Noncombustible construction.



Wood-frame construction with required fire performance characteristics, heavy timber construction, noncombustible construction or any combination.



Heavy timber construction, noncombustible construction or a combination.



Wood-frame construction or any other building system without special fire performance characteristics.

Notes for Group A Occupancies:

- The other floor assemblies in a 1 storey building refers to a sloped floor or a seating area ascending from the main floor in an assembly building.
- No occupancy allowed above or below auditorium other than one serving or depending on it (e.g. washrooms and theatre office).
- No part of auditorium floor can be more than 5m above or below grade.
- Up to 40% of building area permitted as two storeys if used for such things as dressing rooms, theatre offices and washrooms.
- Exterior balconies shall be constructed in accordance with the type of construction required and if these balconies form part of the means of egress then they are required to have a fire-resistance rating equal to that for mezzanines.
- A roof assembly of heavy timber construction is permitted for sprinklered buildings of any area, up to 2 storeys in height. (Structural members in the storey immediately below the roof assembly can be heavy timber construction.)
- Fire-resistance rating waived for roof assembly having at least 6m clearance above main floor in gymnasias and Group A, Division 3 occupancies.
- Wood studs and FRT plywood are permitted in non-loadbearing exterior wall assemblies in unsprinklered buildings 3 storeys or less in building height and in sprinklered buildings of unlimited height.
- Maximum building areas can be doubled if no basement and 1-hour fire separation divides building into two areas, with neither area exceeding values given.
- Sprinklers shall be installed in all spaces below tiers of seats if those spaces are used for occupancy.

DESIGN REQUIREMENT TABLES

Group B — Division 1

Jails, Police Stations²
and Psychiatric
Hospitals, all with
Detention Quarters

B1
Care or
Detention

MAXIMUM BUILDING HEIGHT, STOREYS		Unlimited	1	2	3
MAXIMUM BUILDING AREA m ²	Sprinklered	3.2.2.36. ⁶ Unlimited.	3.2.2.37. ⁶ Unlimited.	12 000	8000
	CONSTRUCTION REQUIREMENTS				
	Basements	● Noncombustible construction.	● Noncombustible construction.		
	Floor Assemblies Above Basements	● 2-hour fire separation.	● 1-hour fire separation.		
	Floor Assemblies Above Crawl Spaces	● Noncombustible construction.	● Noncombustible construction.		
	All Other Floor Assemblies	● 2-hour fire separation.	● 1-hour fire separation.		
	Mezzanines	● 1-hour fire-resistance rating. ¹	● 1-hour fire-resistance rating. ¹		
	Roof Assemblies	◐ Heavy timber in buildings up to two storeys or noncombustible construction. ⁴	◐ Heavy timber in buildings up to two storeys or noncombustible construction. ⁴		
	Loadbearing Walls, Columns, Beams, Arches	● Fire-resistance rating must equal that required for the supported assembly. ⁴	● Fire-resistance rating must equal that required for the supported assembly. ⁴		



● Noncombustible construction.

◐ Heavy timber construction, noncombustible construction or a combination.

◐ Wood-frame construction with required fire performance characteristics, heavy timber construction, noncombustible construction or any combination.

○ Wood-frame construction or any other building system without special fire performance characteristics.

DESIGN REQUIREMENT TABLES

B2
Care or
Detention

Group B — Division 2

Infirmaries, Orphanages, Hospitals, Police Stations³ with Detention Quarters and Psychiatric Hospitals without Detention Quarters

MAXIMUM BUILDING HEIGHT, STOREYS		Unlimited	1	2	3
MAXIMUM BUILDING AREA m ²	Sprinklered	3.2.2.38. Unlimited.	3.2.2.39. Unlimited.	12 000	8000
CONSTRUCTION REQUIREMENTS	Basements	● Noncombustible construction.	● Noncombustible construction.		
	Floor Assemblies Above Basements	● 2-hour fire separation.	● 1-hour fire separation.		
	Floor Assemblies Above Crawl Spaces	● Noncombustible construction.	● Noncombustible construction.		
	All Other Floor Assemblies	● 2-hour fire separation.	● 1-hour fire separation.		
	Mezzanines	● 1-hour fire-resistance rating. ¹	● 1-hour fire-resistance rating. ¹		
	Roof Assemblies	◐ Heavy timber in buildings up to two storeys or noncombustible construction. ⁴	◐ Heavy timber in buildings up to two storeys or noncombustible construction. ⁴		
	Loadbearing Walls, Columns, Beams, Arches	● Fire-resistance rating must equal that required for the supported assembly. ⁴	● Fire-resistance rating must equal that required for the supported assembly. ⁴		

● Noncombustible construction.

◐ Heavy timber construction, noncombustible construction or a combination.

◐ Wood-frame construction with required fire performance characteristics, heavy timber construction, noncombustible construction or any combination.

○ Wood-frame construction or any other building system without special fire performance characteristics.

DESIGN REQUIREMENT TABLES

Group B — Division 2

continued

Infirmaries, Orphanages, Hospitals, Police Stations³ with Detention Quarters and Psychiatric Hospitals without Detention Quarters

B2
Care or Detention

MAXIMUM BUILDING HEIGHT, STOREYS		1	2	1
MAXIMUM BUILDING AREA m ²	Sprinklered	3.2.2.40 2400	1600	3.2.2.41 500
	CONSTRUCTION REQUIREMENTS			
	Basements	<input type="radio"/> No special requirements.		<input type="radio"/> No special requirements.
	Floor Assemblies Above Basements	<input checked="" type="radio"/> 45-minute fire separation.		<input checked="" type="radio"/> 45-minute fire separation.
	Floor Assemblies Above Crawl Spaces	<input type="radio"/> No special requirements.		<input type="radio"/> No special requirements.
	All Other Floor Assemblies	<input checked="" type="radio"/> 45-minute fire separation.		<input type="radio"/> Not applicable.
	Mezzanines	<input checked="" type="radio"/> 45-minute fire-resistance rating if of combustible construction or unrated noncombustible construction. ¹		<input type="radio"/> No special requirements.
	Roof Assemblies	<input type="radio"/> No special requirements.		<input type="radio"/> No special requirements.
	Loadbearing Walls, Columns, Beams, Arches	<input checked="" type="radio"/> Fire-resistance rating must equal that required for the supported assembly.		<input checked="" type="radio"/> Fire-resistance rating must equal that required for the supported assembly.



Noncombustible construction.



Wood-frame construction with required fire performance characteristics, heavy timber construction, noncombustible construction or any combination.



Heavy timber construction, noncombustible construction or a combination.



Wood-frame construction or any other building system without special fire performance characteristics.

Notes for Group B Occupancies:

- Exterior balconies shall be constructed in accordance with the type of construction required and if these balconies form part of the means of egress then they are required to have a fire-resistance rating equal to that for mezzanines.
- Exceeding 1 storey in building height or 600m² in building area.
- Not exceeding 1 storey in building height and 600m² in building area.
- Roof assemblies of heavy timber construction permitted for sprinklered buildings of any area up to 2 storeys in height. (Structural members in the storey immediately below the roof assembly can be heavy timber construction.)
- Wood studs and FRT plywood are permitted in non-loadbearing exterior wall assemblies in sprinklered buildings of any height.
- A building containing an impeded egress zone need not conform to the specified requirements provided the building and occupancy is in accordance with the requirements of Article **3.2.2.19** and the appropriate Article in Subsection 3.2.2.



DESIGN REQUIREMENT TABLES

C
Residential

Group C

Apartments,
Boarding
Houses and
Motels

MAXIMUM BUILDING HEIGHT, STOREYS		Unlimited
MAXIMUM BUILDING AREA m ²	Sprinklered	3.2.2.42. Unlimited.
CONSTRUCTION REQUIREMENTS	Basements	● Noncombustible construction.
	Floor Assemblies Above Basements	● 2-hour fire separation. ²
	Floor Assemblies Above Crawl Spaces	● Noncombustible construction.
	All Other Floor Assemblies	● 2-hour fire separation. ²
	Mezzanines	● 1-hour fire-resistance rating. ³
	Roof Assemblies	◐ Heavy timber in buildings up to two storeys or noncombustible construction. ⁵
	Loadbearing Walls, Columns, Beams, Arches	● Fire-resistance rating must equal that required for the supported assembly. ⁵

● Noncombustible construction.

◐ Heavy timber construction, noncombustible construction or a combination.

◑ Wood-frame construction with required fire performance characteristics, heavy timber construction, noncombustible construction or any combination.

○ Wood-frame construction or any other building system without special fire performance characteristics.

DESIGN REQUIREMENT TABLES

Group C

continued

Apartments,
Boarding
Houses and
Motels



MAXIMUM BUILDING HEIGHT, STOREYS		1	2	3	4	5	6
MAXIMUM BUILDING AREA m ²	Unsprinklered facing 1 street facing 2 streets facing 3 streets	3.2.2.44. Unlimited. Unlimited. Unlimited.	6000 Unlimited. Unlimited.	4000 5000 6000	Not permitted. Not permitted. Not permitted.		
	Sprinklered	3.2.2.43. Unlimited.	Unlimited.	12 000	9000	7200	6000
CONSTRUCTION REQUIREMENTS	Basements	● Subdivided by 1-hour fire separations into areas not exceeding 600m ² , unless sprinklered.					
	Floor Assemblies Above Basements	● 1-hour fire separation. ²					
	Floor Assemblies Above Crawl Spaces	● Noncombustible construction.					
	All Other Floor Assemblies	● 1-hour fire separation. ²					
	Mezzanines	● 1-hour fire-resistance rating. ³					
	Roof Assemblies	◐ 1-hour fire-resistance rating unless sprinklered. ^{4,5}					
Loadbearing Walls, Columns, Beams, Arches	● Fire-resistance rating must equal that required for supported assembly. ⁵						



Noncombustible construction.



Heavy timber construction, noncombustible construction or a combination.



Wood-frame construction with required fire performance characteristics, heavy timber construction, noncombustible construction or any combination.



Wood-frame construction or any other building system without special fire performance characteristics.

DESIGN REQUIREMENT TABLES

C	Residential	<h2 style="margin: 0;">Group C</h2> <p style="margin: 0;">continued</p>	Apartments, Boarding Houses and Motels
----------	--------------------	---	---

MAXIMUM BUILDING HEIGHT, STOREYS	1	2	3	4				
MAXIMUM BUILDING AREA m ²	<table border="1" style="width: 100%; border-collapse: collapse;"> <tr> <td style="width: 25%; padding: 5px;"> Sprinklered 3.2.2.45.⁷ 7200 </td> <td style="width: 25%; padding: 5px;">3600</td> <td style="width: 25%; padding: 5px;">2400</td> <td style="width: 25%; padding: 5px;">1800</td> </tr> </table>				Sprinklered 3.2.2.45. ⁷ 7200	3600	2400	1800
Sprinklered 3.2.2.45. ⁷ 7200	3600	2400	1800					
CONSTRUCTION REQUIREMENTS								
Basements	<input type="radio"/> No special requirements.							
Floor Assemblies Above Basements	<input checked="" type="radio"/> 1-hour fire separation. ¹							
Floor Assemblies Above Crawl Spaces	<input type="radio"/> No special requirements.							
All Other Floor Assemblies	<input checked="" type="radio"/> 1-hour fire separation. ¹							
Mezzanines	<input checked="" type="radio"/> 1-hour fire-resistance rating. ^{1,3}							
Roof Assemblies	<input checked="" type="radio"/> No special requirements.							
Loadbearing Walls, Columns, Beams, Arches	<input checked="" type="radio"/> Fire-resistance rating must equal that required for supported assembly.							

<p><input checked="" type="radio"/> Noncombustible construction.</p> <p><input checked="" type="radio"/> Heavy timber construction, noncombustible construction or a combination.</p>	<p><input checked="" type="radio"/> Wood-frame construction with required fire performance characteristics, heavy timber construction, noncombustible construction or any combination.</p> <p><input type="radio"/> Wood-frame construction or any other building system without special fire performance characteristics.</p>
---	--

DESIGN REQUIREMENT TABLES

Group C

continued

Apartments,
Boarding
Houses and
Motels

C
Residential

MAXIMUM BUILDING HEIGHT, STOREYS		1	2	3	1	2	3
MAXIMUM BUILDING AREA m ²	Unsprinklered	3.2.2.46. ⁷			3.2.2.47.		
	facing 1 street	2400	1200	800	1800	900	600
	facing 2 streets	3000	1500	1000	2250	1125	750
	facing 3 streets	3600	1800	1200	2700	1350	900
	Sprinklered	Not applicable.			3.2.2.48.		
					5400	2700	1800
CONSTRUCTION REQUIREMENTS	Basements	● Subdivided by 1-hour fire separations into areas not exceeding 600m ² .			● Subdivided by 45-minute fire separations into areas not exceeding 600m ² , unless sprinklered.		
	Floor Assemblies Above Basements	● 1-hour fire separation. ¹			● 45-minute fire separation. ¹		
	Floor Assemblies Above Crawl Spaces	○ No special requirements.			○ No special requirements.		
	All Other Floor Assemblies	● 1-hour fire separation. ¹			● 45-minute fire separation. ¹		
	Mezzanines	● 1-hour fire-resistance rating. ^{1,3}			● 45-minute fire-resistance rating, if of combustible construction. ^{1,3}		
	Roof Assemblies	● 1-hour fire-resistance rating.			○ No special requirements.		
	Loadbearing Walls, Columns, Beams, Arches	● Fire-resistance rating must equal that required for the supported assembly.			● Fire-resistance rating must equal that required for the supported assembly.		

● Noncombustible construction.

● Heavy timber construction, noncombustible construction or a combination.

● Wood-frame construction with required fire performance characteristics, heavy timber construction, noncombustible construction or any combination.

○ Wood-frame construction or any other building system without special fire performance characteristics.

Notes for Group C Occupancies:

- When building contains dwelling units exceeding 1 storey (and the provisions of Sentence **3.3.4.2.(3)** of the NBCC are complied with) floor assemblies within dwelling units do not have to be built as fire separations; if there is no dwelling unit above another, the fire-resistance rating requirement for such floors within the dwelling units is waived.
- When building contains dwelling units exceeding 1 storey (and the provisions of Sentence **3.3.4.2.(3)** of the NBCC are complied with) floor assemblies within dwelling units do not have to be built as fire separations, and only 1-hour fire-resistance rating required.
- Exterior balconies shall be constructed in accordance with the type of construction required and if these balconies form part of the means of egress then they are required to have a fire-resistance rating equal to that for mezzanines.
- Waived for sprinklered buildings.
- Roof assemblies of heavy timber construction permitted for sprinklered buildings up to 2 storeys. (Structural members in the storey immediately below the roof assembly can be heavy timber construction.)
- Wood studs and FRT plywood are permitted in non-loadbearing exterior wall assemblies in unsprinklered buildings 3 storeys or less in building height and in sprinklered buildings of unlimited height.
- Heavy timber components or assemblies must provide minimum 1 hour fire-resistance rating.



DESIGN REQUIREMENT TABLES

D Business and Personal Services

Group D

Banks, Barber
Shops, Offices
and Radio
Stations

MAXIMUM BUILDING HEIGHT, STOREYS		Unlimited	1	2	3	4	5	6
MAXIMUM BUILDING AREA m ²	Unsprinklered facing 1 street facing 2 streets facing 3 streets	Not permitted.	3.2.2.50. Unlimited. 7200 4800 3600 2880 2400 Unlimited. Unlimited. 6000 4500 3600 3000 Unlimited. Unlimited. 7200 5400 4320 3600					
	Sprinklered	3.2.2.49. Unlimited.	3.2.2.51. Unlimited. Unlimited. 14 400 10 800 8640 7200					
CONSTRUCTION REQUIREMENTS	Basements	● Noncombustible construction.	● Subdivided by 1-hour fire separations into areas not exceeding 600m ² , unless sprinklered.					
	Floor Assemblies Above Basements	● 2-hour fire separation.	● 1-hour fire separation.					
	Floor Assemblies Above Crawl Spaces	● Noncombustible construction.	● Noncombustible construction.					
	All Other Floor Assemblies	● 2-hour fire separation.	● 1-hour fire separation.					
	Mezzanines	● 1-hour fire-resistance rating. ¹	● 1-hour fire-resistance rating. ¹					
	Roof Assemblies	◐ Heavy timber in buildings up to two storeys or noncombustible construction. ²	◐ 1-hour fire-resistance rating, waived for 1 storey buildings and for sprinklered buildings. ²					
	Loadbearing Walls, Columns, Beams, Arches	● Fire-resistance rating must equal that required for the supported assembly. ²	● Fire-resistance rating must equal that required for the supported assembly. ²					

● Noncombustible construction.

◐ Wood-frame construction with required fire performance characteristics, heavy timber construction, noncombustible construction or any combination.

◑ Heavy timber construction, noncombustible construction or a combination.

○ Wood-frame construction or any other building system without special fire performance characteristics.

DESIGN REQUIREMENT TABLES

Group D

continued

Banks, Barber
Shops, Offices
and Radio
Stations

D
Business
and Personal
Services

MAXIMUM BUILDING HEIGHT, STOREYS		1	2	3	4
MAXIMUM BUILDING AREA m ²	Unsprinklered	Not applicable.			
	Sprinklered	3.2.2.52. ³ 3600	3600	3600	3600
CONSTRUCTION REQUIREMENTS	Basements	<input type="radio"/> No special requirements.			
	Floor Assemblies Above Basements	<input checked="" type="radio"/> 1-hour fire separation.			
	Floor Assemblies Above Crawl Spaces	<input type="radio"/> No special requirements.			
	All Other Floor Assemblies	<input checked="" type="radio"/> 1-hour fire separation.			
	Mezzanines	<input checked="" type="radio"/> 1-hour fire-resistance rating. ¹			
	Roof Assemblies	<input type="radio"/> No special requirements.			
	Loadbearing Walls, Columns, Beams, Arches	<input checked="" type="radio"/> Fire-resistance rating must equal that required for supported assembly.			

Noncombustible construction.

Heavy timber construction, noncombustible construction or a combination.

Wood-frame construction with required fire performance characteristics, heavy timber construction, noncombustible construction or any combination.

Wood-frame construction or any other building system without special fire performance characteristics.

Notes for Group D Occupancies:

- 1 Exterior balconies shall be constructed in accordance with the type of construction required and if these balconies form part of the means of egress then they are required to have a fire-resistance rating equal to that for mezzanines.
- 2 Roof assemblies of heavy timber permitted for sprinklered buildings up to 2 storeys, of any area. (Structural members in the storey immediately below the roof assembly can be heavy timber construction.)
- 3 Heavy timber components or assemblies must provide at least 1-hour fire-resistance rating.
- 4 Wood studs and FRT plywood are permitted in non-loadbearing exterior wall assemblies in unsprinklered buildings 3 storeys or less in building height and in sprinklered buildings of unlimited height.



DESIGN REQUIREMENT TABLES

D
 Business
 and Personal
 Services

Group D

continued

Banks, Barber
Shops, Offices
and Radio
Stations

MAXIMUM BUILDING HEIGHT, STOREYS		1	2	3	1	2
MAXIMUM BUILDING AREA m ²	Unsprinklered	3.2.2.53.			3.2.2.55.	
	facing 1 street	4800	2400	1600	1000	800
	facing 2 streets	6000	3000	2000	1250	1000
	facing 3 streets	7200	3600	2400	1500	1200
	Sprinklered	3.2.2.54.			3.2.2.56.	
		14 400	7200	4800	3000	2400
CONSTRUCTION REQUIREMENTS	Basements	<input checked="" type="radio"/> Subdivided by 45-minute fire separations into areas not exceeding 600m ² , unless sprinklered.			<input checked="" type="radio"/> Subdivided by 45-minute fire separations into areas not exceeding 600m ² , unless sprinklered.	
	Floor Assemblies Above Basements	<input checked="" type="radio"/> 45-minute fire separation.			<input checked="" type="radio"/> 45-minute fire separation.	
	Floor Assemblies Above Crawl Spaces	<input type="radio"/> No special requirements.			<input type="radio"/> No special requirements.	
	All Other Floor Assemblies	<input checked="" type="radio"/> Must be fire separation; 45-minute fire-resistance rating required if of combustible construction.			<input checked="" type="radio"/> Must be fire separation; 45-minute fire-resistance rating required if of combustible construction.	
	Mezzanines	<input checked="" type="radio"/> 45-minute fire-resistance rating if of combustible construction. ¹			<input type="radio"/> No special requirements.	
	Roof Assemblies	<input checked="" type="radio"/> 45-minute fire-resistance rating if of combustible construction, waived for sprinklered buildings and 1-storey buildings with FRTW roof systems if building area is not more than one-half values otherwise permitted, or unrated noncombustible.			<input type="radio"/> No special requirements.	
	Loadbearing Walls, Columns, Beams, Arches	<input checked="" type="radio"/> Loadbearing elements supporting assemblies required to have a fire-resistance rating must have a 45-minute fire-resistance rating or be of unrated noncombustible or combination except that fire separation floor over basements must be supported by a 45-minute rated assembly.			<input checked="" type="radio"/> Loadbearing elements supporting assemblies required to have a fire-resistance rating must have a 45-minute fire-resistance rating or be of unrated noncombustible or combination except that fire separation floor over basements must be supported by a 45-minute rated assembly.	

 Noncombustible construction.

 Heavy timber construction, noncombustible construction or a combination.

 Wood-frame construction with required fire performance characteristics, heavy timber construction, noncombustible construction or any combination.

 Wood-frame construction or any other building system without special fire performance characteristics.

DESIGN REQUIREMENT TABLES

Group E

Department
Stores, Exhibition
Halls and
Supermarkets

E
Mercantile

MAXIMUM BUILDING HEIGHT, STOREYS		Unlimited	1	2	3	4
MAXIMUM BUILDING AREA m ²	Sprinklered	3.2.2.57. Unlimited.	3.2.2.58. ³ 1800 1800 1800 1800			
	CONSTRUCTION REQUIREMENTS					
	Basements	● Noncombustible construction.	○ No special requirements.			
	Floor Assemblies Above Basements	● 2-hour fire separation.	◐ 1-hour fire separation.			
	Floor Assemblies Above Crawl Spaces	● Noncombustible construction.	○ No special requirements.			
	All Other Floor Assemblies	● 2-hour fire separation.	◐ 1-hour fire separation.			
	Mezzanines	● 1-hour fire-resistance rating. ¹	◐ 1-hour fire-resistance rating. ¹			
	Roof Assemblies	◑ Heavy timber in buildings up to two storeys or noncombustible construction. ²	○ No special requirements.			
	Loadbearing Walls, Columns, Beams, Arches	● Fire-resistance rating must equal that required for supported assembly. ²	◐ Fire-resistance rating must equal that required for supported assembly.			



● Noncombustible construction.

◑ Heavy timber construction, noncombustible construction or a combination.

◐ Wood-frame construction with required fire performance characteristics, heavy timber construction, noncombustible construction or any combination.

○ Wood-frame construction or any other building system without special fire performance characteristics.

DESIGN REQUIREMENT TABLES

E

Mercantile

Group E

continued

Department
Stores, Exhibition
Halls and
Supermarkets

MAXIMUM BUILDING HEIGHT, STOREYS		1	2	3	1	2
MAXIMUM BUILDING AREA m ²	Unsprinklered	3.2.2.59.			3.2.2.61.	
	facing 1 street	1500	1200	800	1000	600
	facing 2 streets	1500	1500	1000	1250	750
	facing 3 streets	1500	1500	1500	1500	900
	Sprinklered	3.2.2.60.			3.2.2.62.	
		7200	3600	2400	3000	1800
CONSTRUCTION REQUIREMENTS	Basements	● Subdivided by 45-minute fire separations into areas not exceeding 600m ² , unless sprinklered.			● Subdivided by 45-minute fire separations into areas not exceeding 600m ² , unless sprinklered.	
	Floor Assemblies Above Basements	● 45-minute fire separation.			● 45-minute fire separation.	
	Floor Assemblies Above Crawl Spaces	○ No special requirements.			○ No special requirements.	
	All Other Floor Assemblies	● 45-minute fire separation.			● 45-minute fire separation.	
	Mezzanines	● 45-minute fire-resistance rating if of combustible construction. ¹			○ No special requirements.	
	Roof Assemblies	● 45-minute fire-resistance rating, waived for 1-storey buildings with unrated noncombustible roof systems, for 1-storey buildings with FRTW roof systems and for sprinklered buildings.			○ No special requirements.	
	Loadbearing Walls, Columns, Beams, Arches	● 45-minute fire-resistance rating or unrated noncombustible or a combination thereof if supported assembly required to have a fire-resistance rating, except that fire separation floor over basements and other fire separation floors must be supported by assembly of at least equivalent rating.			● Fire-resistance rating must equal that required for supported assembly.	



Noncombustible construction.



Wood-frame construction with required fire performance characteristics, heavy timber construction, noncombustible construction or any combination.



Heavy timber construction, noncombustible construction or a combination.



Wood-frame construction or any other building system without special fire performance characteristics.

Notes for Group E Occupancies:

- 1 Exterior balconies shall be constructed in accordance with the type of construction required and if these balconies form part of the means of egress then they are required to have a fire-resistance rating equal to that for mezzanines.
- 2 Roof assemblies of heavy timber permitted for sprinklered buildings up to 2 storeys, of any area. (Structural members in the storey immediately below the roof assembly can be heavy timber construction.)
- 3 Heavy timber components or assemblies must provide at least 1-hour fire-resistance rating.
- 4 Wood studs and FRT plywood are permitted in non-loadbearing exterior wall assemblies in unsprinklered buildings 3 storeys or less in building height and in sprinklered buildings of unlimited height.

DESIGN REQUIREMENT TABLES

Group F — Division 1

Distilleries,
Flour Mills, and
Spray Painting
Operations

F1
Industrial

MAXIMUM BUILDING HEIGHT, STOREYS		1	2	3	4	1	2	3
MAXIMUM BUILDING AREA m ²	Sprinklered	3.2.2.63. 9000	4500	3000	2250	3.2.2.64. 3600	1800	1200
	CONSTRUCTION REQUIREMENTS							
	Basements	● Noncombustible construction.				◐ Heavy timber or non-combustible construction.		
	Floor Assemblies Above Basements	● 2-hour fire separation.				◐ Heavy timber or 45-minute noncombustible fire separation.		
	Floor Assemblies Above Crawl Spaces	● Noncombustible construction.				◐ Heavy timber or non-combustible construction.		
	All Other Floor Assemblies	● 2-hour fire separation.				◐ Heavy timber or 45-minute noncombustible fire separation.		
	Mezzanines	● 1-hour fire-resistance rating. ²				◐ Heavy timber or non-combustible construction. ²		
	Roof Assemblies	◐ Heavy timber in buildings up to two storeys or noncombustible construction. ³				◐ Heavy timber or non-combustible construction.		
	Loadbearing Walls, Columns, Beams, Arches	● Fire-resistance rating must equal that required for supported assembly. ³				◐ Fire-resistance rating must equal that required for supported assembly.		



- Noncombustible construction.
- ◐ Heavy timber construction, noncombustible construction or a combination.

- ◐ Wood-frame construction with required fire performance characteristics, heavy timber construction, noncombustible construction or any combination.
- Wood-frame construction or any other building system without special fire performance characteristics.

DESIGN REQUIREMENT TABLES

F1
Industrial

Group F — Division 1

continued

Distilleries,
Flour Mills, and
Spray Painting
Operations

MAXIMUM BUILDING HEIGHT, STOREYS		1	2	1
MAXIMUM BUILDING AREA m ²	Unsprinklered	Not permitted.		3.2.2.66. 800
	Sprinklered	3.2.2.65. 2400	1200	Not applicable.
CONSTRUCTION REQUIREMENTS	Basements	<input type="radio"/> No special requirements.		<input checked="" type="radio"/> Subdivided by 45-minute fire separations into areas not exceeding 600m ² .
	Floor Assemblies Above Basements	<input checked="" type="radio"/> 45-minute fire separation.		<input checked="" type="radio"/> 45-minute fire separation.
	Floor Assemblies Above Crawl Spaces	<input type="radio"/> No special requirements.		<input type="radio"/> No special requirements.
	All Other Floor Assemblies	<input checked="" type="radio"/> Must be fire separation; 45-minute fire-resistance rating if of combustible construction.		<input type="radio"/> No special requirements.
	Mezzanines	<input type="radio"/> No special requirements. ²		<input type="radio"/> No special requirements.
	Roof Assemblies	<input type="radio"/> No special requirements.		<input type="radio"/> No special requirements.
	Loadbearing Walls, Columns, Beams, Arches	<input checked="" type="radio"/> Loadbearing elements supporting assemblies required to have a fire-resistance rating must have a 45-minute fire-resistance rating or be of unrated noncombustible or combination except that fire separation floor over basements must be supported by a 45-minute rated assembly.		<input checked="" type="radio"/> No special requirements except that fire separation floor over basements must be supported by a 45-minute rated assembly.

Noncombustible construction.

Heavy timber construction, noncombustible construction or a combination.

Wood-frame construction with required fire performance characteristics, heavy timber construction, noncombustible construction or any combination.

Wood-frame construction or any other building system without special fire performance characteristics.

DESIGN REQUIREMENT TABLES

Group F — Division 2

Factories, Repair
Garages, Service
Stations and
Warehouses

F2
Industrial

MAXIMUM BUILDING HEIGHT, STOREYS		Unlimited	1	2	3	4
MAXIMUM BUILDING AREA m ²	Sprinklered	3.2.2.67. Unlimited.	3.2.2.68. 18 000	9000	6000	4500
CONSTRUCTION REQUIREMENTS	Basements	● Noncombustible construction.	● Noncombustible construction.			
	Floor Assemblies Above Basements	● 2-hour fire separation.	● 1-hour fire separation.			
	Floor Assemblies Above Crawl Spaces	● Noncombustible construction.	● Noncombustible construction.			
	All Other Floor Assemblies	● 2-hour fire separation.	● 1-hour fire separation.			
	Mezzanines	● 1-hour fire-resistance rating. ²	● 1-hour fire-resistance rating. ²			
	Roof Assemblies	◐ Heavy timber in buildings up to two storeys or noncombustible construction. ³	◐ Heavy timber in buildings up to two storeys or noncombustible construction. ³			
	Loadbearing Walls, Columns, Beams, Arches	● Fire-resistance rating must equal that required for the supported assembly. ³	● Fire-resistance rating must equal that required for the supported assembly. ³			



● Noncombustible construction.

◐ Heavy timber construction, noncombustible construction or a combination.

◐ Wood-frame construction with required fire performance characteristics, heavy timber construction, noncombustible construction or any combination.

○ Wood-frame construction or any other building system without special fire performance characteristics.

DESIGN REQUIREMENT TABLES

F2

Industrial

Group F — Division 2

continued

Factories, Repair
Garages, Service
Stations and
Warehouses

MAXIMUM BUILDING HEIGHT, STOREYS		1	2	3	4	1	2
MAXIMUM BUILDING AREA m ²	Unsprinklered	3.2.2.69.				3.2.2.71.	
	facing 1 street	1500	1500	1070	Not permitted.	1000	600
	facing 2 streets	1500	1500	1340	Not permitted.	1250	750
	facing 3 streets	1500	1500	1500	Not permitted.	1500	900
	Sprinklered	3.2.2.70.				3.2.2.72.	
		9600	4800	3200	2400	4500	1800
CONSTRUCTION REQUIREMENTS	Basements	<input checked="" type="radio"/> Subdivided by 45-minute fire separations into areas not exceeding 600m ² , unless sprinklered.				<input checked="" type="radio"/> Subdivided by 45-minute fire separations into areas not exceeding 600m ² , unless sprinklered.	
	Floor Assemblies Above Basements	<input checked="" type="radio"/> 45-minute fire separation.				<input checked="" type="radio"/> 45-minute fire separation.	
	Floor Assemblies Above Crawl Spaces	<input type="radio"/> No special requirements.				<input type="radio"/> No special requirements.	
	All Other Floor Assemblies	<input checked="" type="radio"/> 45-minute fire separation.				<input checked="" type="radio"/> Must be fire separation; 45-minute fire-resistance rating if of combustible construction.	
	Mezzanines	<input checked="" type="radio"/> 45-minute fire-resistance rating if of combustible construction. ²				<input type="radio"/> No special requirements.	
	Roof Assemblies	<input checked="" type="radio"/> 45-minute fire-resistance rating if of combustible construction, waived for 1-storey buildings with FRTW roof systems or if building is sprinklered or unrated noncombustible.				<input type="radio"/> No special requirements. ²	
	Loadbearing Walls, Columns, Beams, Arches	<input checked="" type="radio"/> Loadbearing elements supporting assemblies required to have a fire-resistance rating must have a 45-minute fire-resistance rating or be of unrated noncombustible or combination except that fire separation floor over basements and other fire separation floors must be supported by an assembly of at least equivalent rating.				<input checked="" type="radio"/> Loadbearing elements supporting assemblies required to have a fire-resistance rating must have a 45-minute fire-resistance rating or be of unrated noncombustible or combination except that fire separation floor over basements must be supported by a 45-minute rated assembly.	



Noncombustible construction.



Heavy timber construction, noncombustible construction or a combination.



Wood-frame construction with required fire performance characteristics, heavy timber construction, noncombustible construction or any combination.



Wood-frame construction or any other building system without special fire performance characteristics.

DESIGN REQUIREMENT TABLES

Group F — Division 3

Laboratories,
Sales Rooms,
Storage Garages
and Workshops

F3
Industrial

MAXIMUM BUILDING HEIGHT, STOREYS		Unlimited	1	2	3	4	5	6
MAXIMUM BUILDING AREA m ²	Unsprinklered facing 1 street facing 2 streets facing 3 streets	Not permitted. Not permitted. Not permitted.	3.2.2.74. Unlimited. Unlimited. Unlimited.	7200 9000 10 800	4800 6000 7200	3600 4500 5400	2880 3600 4320	2400 3000 3600
	Sprinklered	3.2.2.73. Unlimited.	3.2.2.75. Unlimited.	21 600	14 400	10 800	8640	7200
CONSTRUCTION REQUIREMENTS	Basements	● Noncombustible construction.	● Subdivided by 1-hour fire separations into areas not exceeding 600m ² , unless sprinklered. ⁵					
	Floor Assemblies Above Basements	● 2-hour fire separation. ^{1, 4}	● 1-hour fire separation. ¹					
	Floor Assemblies Above Crawl Spaces	● Noncombustible construction.	● Noncombustible construction.					
	All Other Floor Assemblies	● 2-hour fire separation. ^{1, 4}	● 1-hour fire separation. ¹					
	Mezzanines	● 1-hour fire resistance rating. ²	● 1-hour fire-resistance rating. ²					
	Roof Assemblies	◐ Heavy timber in buildings up to two storeys or non-combustible construction. ³	◐ 1-hour fire-resistance rating unless sprinklered. ³					
Loadbearing Walls, Columns, Beams, Arches	● Fire-resistance rating must equal that required for the supported assembly. ³	● Fire-resistance rating must equal that required for the supported assembly. ³						



Noncombustible construction.



Heavy timber construction, noncombustible construction or a combination.



Wood-frame construction with required fire performance characteristics, heavy timber construction, noncombustible construction or any combination.



Wood-frame construction or any other building system without special fire performance characteristics.

DESIGN REQUIREMENT TABLES

F3
Industrial

Group F — Division 3

continued

Laboratories,
Sales Rooms,
Storage Garages
and Workshops

MAXIMUM BUILDING HEIGHT, STOREYS		1	2	3	4	1	2
MAXIMUM BUILDING AREA m ²	Unsprinklered	3.2.2.76.				3.2.2.78.	
	facing 1 street	4800	2400	1600	1200	1600	800
	facing 2 streets	6000	3000	2000	1500	2000	1000
	facing 3 streets	7200	3600	2400	1800	2400	1200
	Sprinklered	3.2.2.77.				3.2.2.79.	
		14 400	7200	4800	3600	7200	2400
CONSTRUCTION REQUIREMENTS	Basements	<input checked="" type="radio"/> Subdivided by 45-minute fire separations into areas not exceeding 600m ² , unless sprinklered. ⁵				<input checked="" type="radio"/> Subdivided by 45-minute fire separations into areas not exceeding 600m ² , unless sprinklered. ⁵	
	Floor Assemblies Above Basements	<input checked="" type="radio"/> 45-minute fire separation. ¹				<input checked="" type="radio"/> 45-minute fire separation. ¹	
	Floor Assemblies Above Crawl Spaces	<input type="radio"/> No special requirements.				<input type="radio"/> No special requirements.	
	All Other Floor Assemblies	<input checked="" type="radio"/> Must be fire separation; 45-minute fire-resistance rating if of combustible construction. ¹				<input checked="" type="radio"/> Must be fire separation; 45-minute fire-resistance rating if of combustible construction. ¹	
	Mezzanines	<input checked="" type="radio"/> 45-minute fire-resistance rating if of combustible construction. ²				<input type="radio"/> No special requirements.	
	Roof Assemblies	<input checked="" type="radio"/> 45-minute fire-resistance rating if of combustible construction, waived if sprinklered or for 1-storey buildings with FRTW roof systems if building area is not more than one-half values otherwise permitted; or unrated noncombustible construction.				<input type="radio"/> No special requirements.	
	Loadbearing Walls, Columns, Beams, Arches	<input checked="" type="radio"/> Loadbearing elements supporting assemblies required to have a fire-resistance rating must have a 45-minute fire-resistance rating or be of unrated noncombustible or combination except that fire separation floor over basements must be supported by a 45-minute rated assembly.				<input checked="" type="radio"/> Loadbearing elements supporting assemblies required to have a fire-resistance rating must have a 45-minute fire-resistance rating or be of unrated noncombustible or combination except that fire separation floor over basements must be supported by a 45-minute rated assembly.	

Noncombustible construction.

Heavy timber construction, noncombustible construction or a combination.

Wood-frame construction with required fire performance characteristics, heavy timber construction, noncombustible construction or any combination.

Wood-frame construction or any other building system without special fire performance characteristics.

DESIGN REQUIREMENT TABLES

Group F — Division 3

continued

Laboratories,
Sales Rooms,
Storage Garages
and Workshops

F3
Industrial

MAXIMUM BUILDING HEIGHT, STOREYS		1
MAXIMUM BUILDING AREA m ²	Unsprinklered facing 1 street facing 2 streets facing 3 streets	3.2.2.80. 5600 7000 8400
	Sprinklered	3.2.2.81. 16 800
CONSTRUCTION REQUIREMENTS	Basements	⦿ Subdivided by 45-minute fire separations into areas not exceeding 600m ² , unless sprinklered. ⁵
	Floor Assemblies Above Basements	⦿ 45-minute fire separation, heavy timber or noncombustible construction. ¹
	Floor Assemblies Above Crawl Spaces	⦿ Heavy timber or noncombustible construction.
	All Other Floor Assemblies	Not applicable.
	Mezzanines	⦿ Heavy timber or noncombustible construction. ²
	Roof Assemblies	⦿ Heavy timber or noncombustible construction.
	Loadbearing Walls, Columns, Beams, Arches	⦿ Heavy timber or unrated noncombustible or a combination thereof except that fire separation floor over basements must be supported by a 45-minute rated assembly.



Noncombustible construction.



Heavy timber construction, noncombustible construction or a combination.



Wood-frame construction with required fire performance characteristics, heavy timber construction, noncombustible construction or any combination.



Wood-frame construction or any other building system without special fire performance characteristics.

DESIGN REQUIREMENT TABLES

F3

Industrial

Group F — Division 3

continued

Power Plants
and Manufacture
or Storage of
Noncombustibles

MAXIMUM BUILDING HEIGHT, STOREYS		1
MAXIMUM BUILDING AREA m ²	Unsprinklered or Sprinklered	3.2.2.32. Unlimited.
USE AND OCCUPANCY RESTRICTION		Must be used solely for low fire load occupancies such as power generating plants or plants for the manufacture or storage of noncombustibles such as asbestos, brick, cement, concrete or steel.
CONSTRUCTION REQUIREMENTS	Basements	● Subdivided by 45-minute fire separations into areas not exceeding 600m ² , unless sprinklered.
	Floor Assemblies Above Basements	● 45-minute fire separation.
	Floor Assemblies Above Crawl Spaces	● Noncombustible construction.
	All Other Floor Assemblies	Not applicable.
	Mezzanines	● Noncombustible construction. ²
	Roof Assemblies	◐ Noncombustible construction or, if sprinklered, heavy timber is permitted. ³
	Loadbearing Walls, Columns, Beams, Arches	● Fire-resistance rating must equal that required for the supported assembly. ³

● Noncombustible construction.

◐ Heavy timber construction, noncombustible construction or a combination.

◑ Wood-frame construction with required fire performance characteristics, heavy timber construction, noncombustible construction or any combination.

○ Wood-frame construction or any other building system without special fire performance characteristics.

DESIGN REQUIREMENT TABLES

Group F — Division 3

continued

Storage
Garages

F3
Industrial

MAXIMUM BUILDING HEIGHT, m	22m in height measured between grade and the ceiling level of the top storey.	
MAXIMUM BUILDING AREA m ²	Unsprinklered or Sprinklered	3.2.2.83. 10 000
USE AND OCCUPANCY RESTRICTION	Must be used as a storage garage; no other occupancy permitted above the garage. All storeys must be constructed as open air storeys and every portion of each floor area must be within 60m of an exterior wall opening.	
CONSTRUCTION REQUIREMENTS	Basements	● Noncombustible construction.
	Floor Assemblies Above Basements	● 45-minute fire separation. ¹
	Floor Assemblies Above Crawl Spaces	● Noncombustible construction. ¹
	All Other Floor Assemblies	● Noncombustible construction. ¹
	Mezzanines	● Noncombustible construction.
	Roof Assemblies	◐ Noncombustible construction or, if sprinklered, heavy timber is permitted. ³
	Loadbearing Walls, Columns, Beams, Arches	● Noncombustible construction. ³



Noncombustible construction.



Wood-frame construction with required fire performance characteristics, heavy timber construction, noncombustible construction or any combination.



Heavy timber construction, noncombustible construction or a combination.



Wood-frame construction or any other building system without special fire performance characteristics.

Notes for Group F Occupancies:

- 1 Unprotected openings for vehicle ramps permitted through floor separations in storage garages **3.1.8.1.(2) & 3.2.8.2.(2)**.
- 2 Exterior balconies shall be constructed in accordance with the type of construction required and if these balconies form part of the means of egress then they are required to have a fire-resistance rating equal to that for mezzanines.
- 3 Roof assemblies of heavy timber permitted for sprinklered buildings up to 2 storeys, of any area. (Structural members in the storey immediately below the roof assembly can be heavy timber construction.)
- 4 Reduced to one hour for storage garage with all storeys having at least 25% of total area of perimeter walls on each storey open to outdoors and distributed to provide cross-ventilation.
- 5 Waived for storage garages having at least 25% of total area of perimeter walls on each storey open to outdoors and distributed to provide cross-ventilation **3.2.1.5.(2)**.
- 6 Wood studs and FRT plywood are permitted in non-loadbearing exterior wall assemblies in unsprinklered buildings 3 storeys or less in building height and in sprinklered buildings of unlimited height.





5



Structural Fire Protection

5.1	General Information	131
5.2	Fire Separations	133
	Continuity of Fire Separations	134
	Firewalls	142
5.3	Fire-Resistance Ratings	147
	History	147
	Fire-Resistance Testing	147
	Availability of Test Results	153
	Alternative Test Standards	155
5.4	Alternative Methods for Determining Fire-Resistance Ratings	157
	Component Additive Method	157
	Fire and Sound Resistance Tables	166
	Calculating Fire Resistance of Glulam Timbers	168
	Fire Modelling	171
	Extrapolation of Data from Fire-Resistance Tests	172
5.5	Fire-Resistance Rating Requirements in the NBCC	175
	History	175
	Fire-Resistance Rating Requirements for Structural Assemblies ..	176
	Floor Assemblies in Residential Occupancies	178
	Fire-Resistance Rating Requirements of Loadbearing Structural Elements	179
	Exceptions to Fire-Resistance Rating Requirements	182
5.6	Fire Protection Requirements for Mezzanines and Atriums ...	185
5.7	Fire Stops	189
5.8	Sprinkler Alternatives	193
	Chapter Summary	195



5.1 General Information

Chapter 3 explained fire separation, fire resistance, and compartmentation as means of satisfying the Contain Fire by Construction branch of the NFPA Fire Safety Concepts Tree. It also explained *NBCC* limits on combustibility and flammability of building materials which limit fire growth and delay full room involvement in a fire (flashover).

These restrictions cannot ensure that a fire will not reach flashover because little control exists over the flammability of building contents such as furniture and furnishings. National Fire Incident Reporting System data suggests that about one in four fires will reach the fully developed stage. This stage poses the highest danger of the fire spreading to the rest of the building.

The Contain Fire by Construction branch of the NFPA Fire Safety Concepts Tree (Figure 3.1) has two parts:

- Control Movement of Fire
- Provide Structural Stability

The branch objective will only be met if both elements are satisfied.

The *NBCC* uses the following methods to achieve the Contain Fire by Construction objective:

- minimum fire-resistance ratings
- compartmentation
- active protection in the form of automatic sprinklers

The requirements for these forms of protection are determined based on occupancy and size of building. This ensures building occupants time to evacuate and also allows for fire department entry.

This chapter explains:

- fire separations as a system for creating fire compartments
- determining the fire resistance of these assemblies
- maintaining the integrity of fire separations
- requirements of firewalls
- the advantages of sprinklers, particularly with regard to the increased use of wood products
- the requirements for mezzanines and large openings through floor assemblies such as atriums

Wood stud wall assembly being removed from the furnace after a fire-resistance test



5.2 Fire Separations

A fire compartment is like a box designed to contain a fire for a limited time within a building.

Fire compartment is defined as: “an enclosed space in a building that is separated from all other parts of the building by enclosing construction providing a fire separation having a required fire-resistance rating.”

The rated fire separations, that is, the building floors and interior walls, are therefore the basic constituents of fire compartmentation.

Fire separation is defined as: “a construction assembly that acts as a barrier against the spread of fire.”

To achieve its purpose of containing the fire by construction, a fire separation must have fire resistance and continuity. There are exceptions to this in the *NBCC*.

There are instances where an assembly may need to be built as a fire separation to restrict the passage of smoke and fire but may not need a fire-resistance rating. In such cases the fire separation need only remain in place long enough to ensure that occupants can leave the area, or, until a sprinkler system is activated that will control and usually suppress the fire.

FIGURE 5.1

Large multi-unit buildings are divided by rated fire separations to create fire compartments



Example 5.1

Occupancy: Group D, office

Building Height: two storeys

Building Area: 1000m²

Sprinklered: no

Construction requirements:

- The second floor assembly must be a fire separation. If the assembly is of combustible construction, a 45 minute fire-resistance rating (FRR) is required. **3.2.2.55.**
- Construction supporting the second floor assembly can be unrated noncombustible construction but, if of combustible construction, requires a 45 minute FRR. **3.2.2.55.**
- The floor assembly over the basement must be a fire separation with a 45 minute FRR regardless of construction type, with all supports having at least a 45 minute FRR. **3.2.1.4.**

As noted, a noncombustible floor assembly for the second floor would not require a fire-resistance rating. However, it must still be designed as a fire separation, with all penetrations protected in accordance with Subsection **3.1.9.** to prevent the passage of smoke and hot fire gases. Without a “required” fire-resistance rating, this noncombustible floor assembly, although constructed as a fire separation, would not be considered as one of the boundary elements of a fire compartment (see definition of fire compartment).

Example 5.2

Consider a public corridor in a floor area of an office building that is sprinklered.

Construction requirements:

- The partitions forming the walls of a corridor must be built as fire separations but no fire-resistance rating is required. **3.3.1.4.(3)**

In this case, the partitions forming the walls of a corridor need only be designed to restrict the passage of smoke and fire for a short period. The sprinkler system, depending on the heat release rate of the fire, should activate within 10 minutes. Once activated, the sprinkler waterspray is expected to limit fire growth and thereby smoke production, preventing the fire from spreading beyond the room where it originated.

CONTINUITY OF FIRE SEPARATIONS

General

3.1.8.1. The *NBCC* requires that all fire separations be constructed as continuous elements. Floors and interior walls of a building must incorporate openings to allow for the passage of people and building services. It is critical that these openings be protected so that the fire separation and the desired compartmentation are maintained.

Fire rarely spreads from one fire compartment to another by burning through floors or walls. Fire usually spreads through:

- concealed spaces in ceilings or attics
- heating, ventilating and air-conditioning ducts
- holes made through fire separations for the passage of electrical wires
- open doors

Each fire separation opening must be protected by a barrier or be fire stopped with materials that will withstand smoke and hot fire gases for a specified period. Concealed spaces must be given special consideration to ensure that they will not act as flues through which a fire may burn or smoke may spread undetected.

It is common to run heating, ventilating and air-conditioning ducts as well as plumbing, electrical cables and other building services above a suspended ceiling. This ceiling membrane may or may not contribute to the fire-resistance rating of the floor assembly.

3.1.8.3.(2) Vertical fire separations must be carried through the ceiling, be tightly fitted to the underside of the floor or roof, and have the required fire-resistance rating over its entire height if (Figure 5.2A):

- the ceiling membrane is unrated
- the floor or roof together with the ceiling membrane were tested as an assembly

3.6.4.2. Vertical fire separations may be terminated at the underside of the ceiling membrane if (Figure 5.2B):

- the ceiling membrane has an equivalent fire-resistance rating to that required for the vertical fire separation
- the ceiling membrane has a 30-minute fire-resistance rating where the vertical fire separation requires only a 45-minute fire-resistance rating

The concealed space above the ceiling then becomes another compartment and is subject to fire stopping requirements (Section 5.7).

3.1.8.3.(3) Where a vertical shaft such as a stairwell goes through a floor assembly, a smoke-tight joint must be provided where the floor assembly abuts the shaft. This reduces the possibility of smoke spreading to upper floors. The vertical separations which enclose the shaft must run continuously through all concealed spaces formed by suspended ceilings (Figure 5.3).

Protection of Openings by Closures

The most vulnerable points of fire separations are the openings such as doors and holes for the passage of building services. It is essential that these openings be protected with closures: doors, shutters, fire dampers, wired glass or glass blocks. Such devices or assemblies must be rated for fire exposure in accordance with specific test standards depending on the type of closure.



FIGURE 5.2A

Continuity of vertical fire separations

Assembly rating

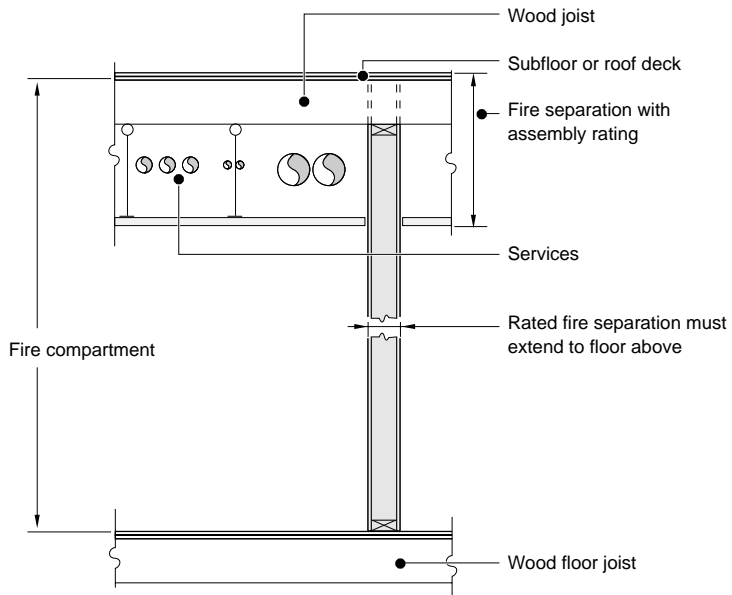

FIGURE 5.2B

Continuity of vertical fire separations

Membrane rating

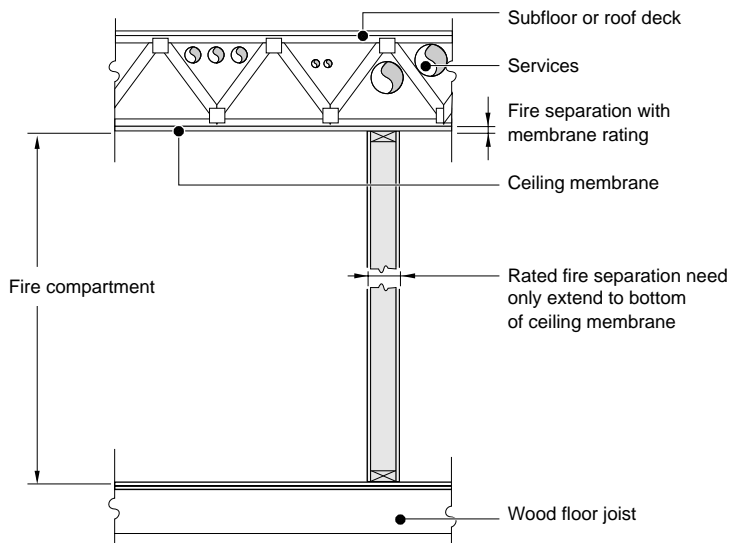
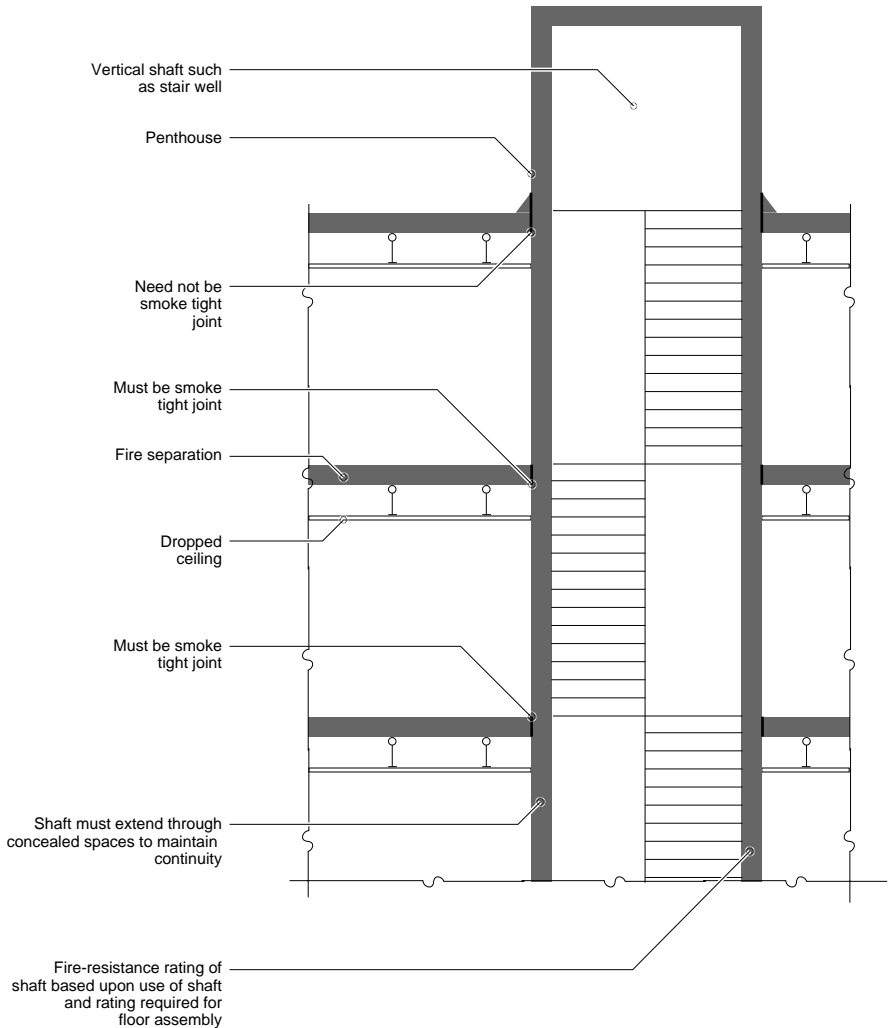

FIGURE 5.3
Vertical shafts



3.1.8.4. The *NBCC* references several ULC standards covering doors, window and glass block assemblies, and fire dampers. It also references NFPA 80, *Standard for Fire Doors and Windows*, which contains detailed installation specifications for most types of closures.

The *NBCC* imposes limits on the size of openings permitted in fire separations as follows:

3.1.8.6.(1) For fire separations having an unsprinklered fire compartment on either side:

- maximum area permitted for any one opening is 11m²
- no dimension greater than 3.7m
- no limit to the number of openings



3.1.8.6.(2) For fire separations having sprinklered fire compartments on both sides:

- maximum area permitted for any one opening is 22m²
- no dimension greater than 6.0m
- no limit to the number of openings

3.1.10.5 For firewalls:

- same restrictions on size and width as for fire separations
- aggregate width of openings cannot exceed 25% of the wall length

3.1.8.4. Closures are classified by fire-protection ratings while fire separations are classified by fire-resistance ratings. The test for fire-protection rating for closures does not contain the heat transmission criteria which is in the fire-resistance test for fire separations. As for fire separations, closures must be installed in the same way as the tested assembly, including frame and hardware.

TABLE 3.1.8.4 The fire-protection rating required for closures is less than the fire-resistance rating required for fire separations because:

- combustible materials are not likely to be stored immediately against closures, such as doors and windows
- closures for building services are a small non-structural portion of the fire separation

3.1.8.10. Door assemblies with a fire-protection rating of 20 minutes or greater are acceptable closures for:

- fire separations with a fire-resistance rating not greater than 45 minutes in buildings not more than 3 storeys in building height
- 1-hour rated fire separation between corridors and specific occupancies such as sleeping rooms, classrooms, offices and libraries

Wood doors can be used in the above applications if:

- they are tested and labelled by a recognised testing agency in accordance with ULC Standard CAN4-S104, *Standard Method for Fire Tests of Door Assemblies*
- they are solid core wood doors of minimum 45mm thickness designed in conformance with ULC Standard CAN4-S113, *Standard Specification for Wood Core Doors Meeting the Performance Required by CAN4-S104 for Twenty Minute Fire-Rated Closure Assemblies*

The installation requirement for noncombustible sills in NFPA 80, *Fire Doors and Windows*, does not apply to 20-minute rated doors because the concrete slab sills it specifies are impractical in 45-minute rated wood-frame construction. Wood sills may be used for these applications.

3.1.8.15. There are limits to temperature rise on the unexposed side of closures in the following instances:

- doors requiring a fire-protection rating of 45 minutes or more leading directly to exit enclosures from the floor area in buildings over three storeys
- doors located between dead-end corridors and adjacent occupancies where the corridor provides the only access to exit, and the corridor is required to have a fire-resistance rating
- doors in firewalls

These limitations are applied because radiant heat from these doors could prevent occupants from passing in front of them in exit stair shafts; it could also endanger people trapped in suites in dead-end corridors with no other exit facilities. Table 5.1 shows the temperature rise limits and gives maximum permissible areas of wired glass or glass blocks in doors and walls.

Wired glass and glass blocks limit the passage of flames for a certain duration, but do not block radiant heat. Thus, in certain locations, they could restrict evacuation, or allow ignition of combustible materials on the unexposed side. With the exception of the specific instances listed in Table 5.1, the *NBCC* allows wired glass and glass blocks to protect openings in fire separations which require a fire-resistance rating. The rating required must not be more than one hour, and the glass or blocks must conform to prescriptive assembly requirements.

3.1.8.11. Closures in fire separations must remain closed or close automatically under fire

conditions to be effective. Doors, because of their size, are a particular concern. The *NBCC* requires self-closing devices on doors in fire separations with the following exceptions:

- doors between corridors and classrooms in buildings of not more than three storeys
- doors between corridors and offices in buildings of not more than three storeys provided the door is not located in a dead-end portion of the corridor

These closures are exempt because building height is limited and occupants are alert. Doors in health care facilities are covered by specific compartmentation requirements.

Such protection cannot be over-emphasised in occupancies such as hotels and apartment buildings: a suite door left open could allow hot fire gases and smoke to fill a corridor.

3.1.8.12. Hold-open devices on closures which close the door automatically in case of fire are allowed. These devices are generally:

- activated by a fusible link which will automatically close when a specified temperature is reached, or
- controlled by an electromagnetic device which releases the door on a signal from a fire alarm system or smoke detector

3.1.8.12. Conditions for use of each type of device depend on the location of the closure and are specified in the *NBCC*.



TABLE 5.1

**Restrictions
on temperature
rise and
glazing for
closures**

Location	Minimum Required Fire-Protection Rating of Door hour	Maximum Temperature Rise on Opaque Portion of Unexposed Side of Door °C	Maximum Area of Wired Glass in a Door cm²	Maximum Aggregate Area of Wired Glass Panels and Glass Block not in a Door cm²
Between a dead-end corridor and an adjacent occupancy where the corridor provides the only access to exit and is required to have a fire-resistance rating	< 3/4	no limit	no limit	no limit
	3/4	250 after 1/2 hour	645	645
Between an exit enclosure and the remainder of the floor area in buildings not more than three storeys in building height	all ratings	no limit	8,000	8,000
Between an exit enclosure and the remainder of the floor area (except as permitted above)	3/4	250 after 1/2 hour	645	645
	1 1/2	250 after 1 hour	645	645
	2	250 after 1 hour	645	645
In a firewall	1 1/2	250 after 1/2 hour	645	0
	3	250 after 1 hour	0	0

Source: National Building Code of Canada, 1995

Protection of Small Openings

Fire separations have numerous small openings for building services. *NBCC* requirements ensure that openings do not channel hot gases, smoke and flames to adjacent fire compartments. If a duct or pipe which penetrates a fire separation melts or collapses on the fire exposed side, heat and flames can travel through the opening. This will circumvent the protection offered by the fire separation assembly.

3.1.8.7. Most ducts that connect two fire compartments or that penetrate an assembly required to have a fire-resistance rating, must be equipped with a fire damper.

3.1.8.8. Fire dampers are not required when the duct:

- penetrates a vertical fire separation not required to have a fire-resistance rating
- is noncombustible and penetrates a horizontal fire separation not required to have a fire-resistance rating
- serves commercial cooking equipment

For ducts that are noncombustible and have a melting point above 760°C, fire dampers are not required when the duct:

- is continuous and penetrates a required vertical suite separation, in other than a Group B and Group C occupancy
- penetrates a fire separation enclosing a vertical service space, provided the duct is not connected to any common riser and separately exhausts directly

to the outside at the top of the service space

- is a branch duct connected to exhaust risers under negative pressure having upward air flow and the branch duct is carried up into the riser at least 500mm
- is a branch duct with a cross-sectional area not more than 0.013m² that serves air-conditioning units or combined air-conditioning and heating units and discharges not more than 1.2m above the floor

3.1.9.4. Pipes penetrating fire separations are required to be noncombustible except for the following:

- when the fire compartments on each side of the fire separation are sprinklered
- combustible water distribution piping up to 30mm in diameter is permitted to penetrate a vertical fire separation if the piping is sealed with a fire stop system with an F rating equivalent to the fire-protection rating for closures in the fire separation
- combustible drain, waste and vent pipes, not located in a vertical shaft, can be used if the piping is sealed with a fire stop system with an F rating equivalent to the fire-resistance rating of the fire separation

Combustible water piping requirements are more lenient because the piping is normally filled with water which protects the pipe. The requirements for combustible drain, waste and vent



pipes are more stringent because these are not filled with water and are usually open to the outside air which creates an internal stack effect (Figure 10.2).

3.1.9.3. Electrical wiring and optical fibre cables penetrating an assembly required to have a fire-resistance rating are required to be in noncombustible raceways except for the following:

- single conductor metal sheathed cables with diameter greater than 25mm with combustible jacketing are permitted to penetrate a fire separation provided the cables are not grouped
- cables, including optical fibre cables, or wires, singly or grouped, with combustible insulation, jackets or sheaths that conform to Clause **3.1.5.17.(1)(a)**, that do not exceed 25mm in diameter

Nonmetallic raceways containing any type of electrical wiring and cables, including optical fibre cables, are permitted to penetrate an assembly required to have a fire-resistance rating provided:

- the raceway exhibits a vertical char of not more than 1.5m when fire tested in accordance with Article **3.1.5.19**
- the diameter of the raceway does not exceed 25mm

3.1.9.2. The combustibility requirements for ducts, pipes or electrical wiring in fire separations apply only if these components were not fire tested in the assembly. If an assembly was tested in a standard fire-resistance test

with the building services incorporated into it, and attained a rating, it can be used, regardless of the amount of combustible material it contains. The assembly with the building services has demonstrated its ability to sustain a load and resist flames and passage of hot gases as a system for the duration of the fire test.

A fire separation must offer a tight barrier to perform its function. There must not be any gaps between a membrane and anything that penetrates the separation. This applies even if the penetrating item is noncombustible.

3.1.9.1. The *NBCC* requires that penetrations through a membrane forming part of an assembly required to have a fire-resistance rating or a fire separation be:

- tight fitting or
- sealed at the perimeter by a fire stop system conforming to ULC Standard CAN4-S115, *Standard Method of Test of Fire Stop Systems*

These fire stop systems are, for the most part, proprietary systems which can resist the passage of flames for a given duration. The test evaluates these systems without testing an entire assembly.

FIREWALLS

The firewall performs the function of separating adjoining buildings sharing a common lot line, to protect the second property for as long as it takes for a fire to burn itself out on the first property. This is the main reason why masonry or

FIGURE 5.4

Wood joists in non-combustible fire separations or firewalls

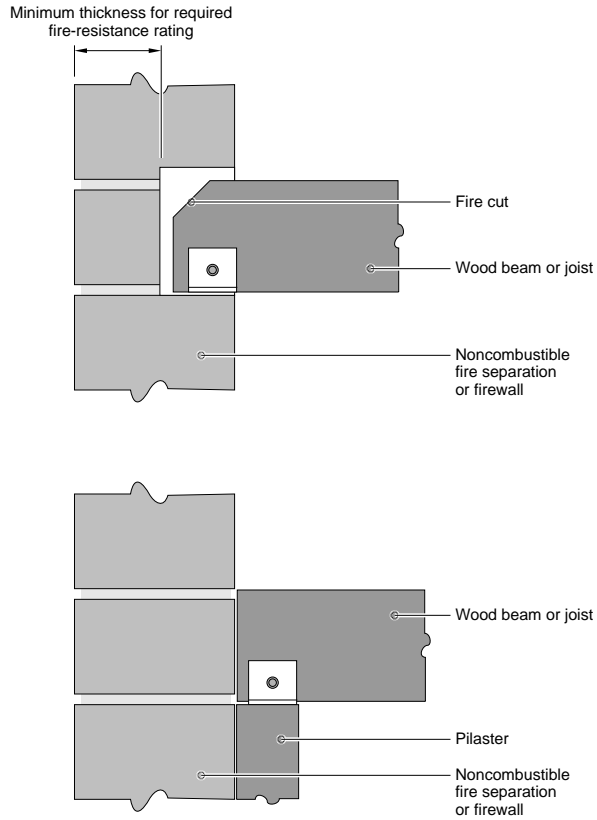
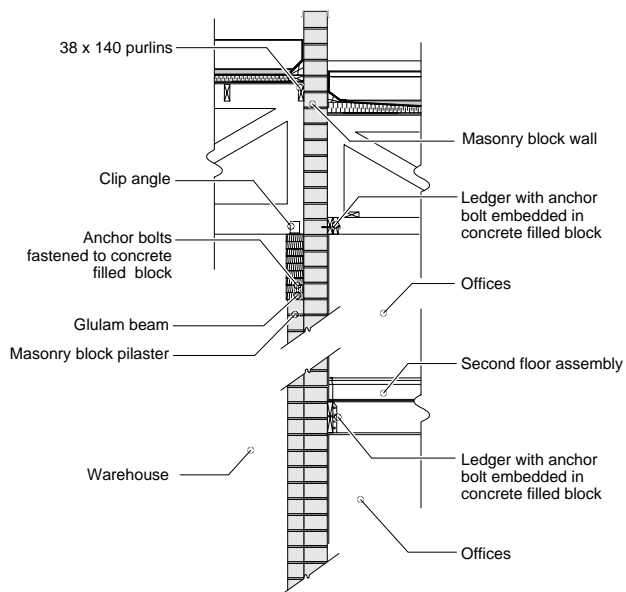

FIGURE 5.5

Fire wall connection details



Note:
As shown in Figure 5.6



FIGURE 5.6

Erection of trusses onto a firewall



concrete construction must be used. Depending on the occupancies it separates, a firewall may require a fire-resistance rating of two or four hours.

3.1.10. Firewalls are a special type of fire separation that must withstand prolonged fire exposure from either side without collapse. The requirements for firewalls are:

- constructed of masonry or concrete
- adjoining construction on the fire exposed side can collapse without affecting it (must be a free-standing structure)
- a fire-resistance rating of 2 or 4 hours
- must extend through all storeys from the basement slab up through the roof
- must terminate at a roof slab of reinforced concrete with a fire-resistance rating equal to half of the firewall, or must extend through the roof where it must form a parapet of 150mm for a two hour wall or 900mm for a four hour wall
- openings in firewalls have the same restrictions on size and width as fire separations **3.1.8.6.**
- the aggregate width of openings cannot exceed 25% of the wall length **3.1.10.5.**
- combustible projections, such as balconies, on one side of a firewall are not permitted within 2.4m of window and door openings or combustible projections on the other side of a firewall

2.1.6.1. A firewall can be a party wall separating two properties built on the lot line. It can also subdivide a building so that each portion is considered as a separate building for the purpose of determining the minimum fire protection requirements. A large building requiring noncombustible construction may be divided by firewalls so that each section is small enough to permit the use of wood-frame construction.

3.1.10.1. Although firewalls must be made of masonry or concrete, wood roof constructions can be used effectively with parapeted firewalls. Wood floors can be framed into firewalls provided that the thickness of the masonry or concrete necessary for the required fire resistance is maintained. Joist connections and supports must be designed so that the collapse of the floor during a fire will not cause the collapse of the firewall (Figures 5.4 to 5.6).

FIGURE 5.7

Firewall support

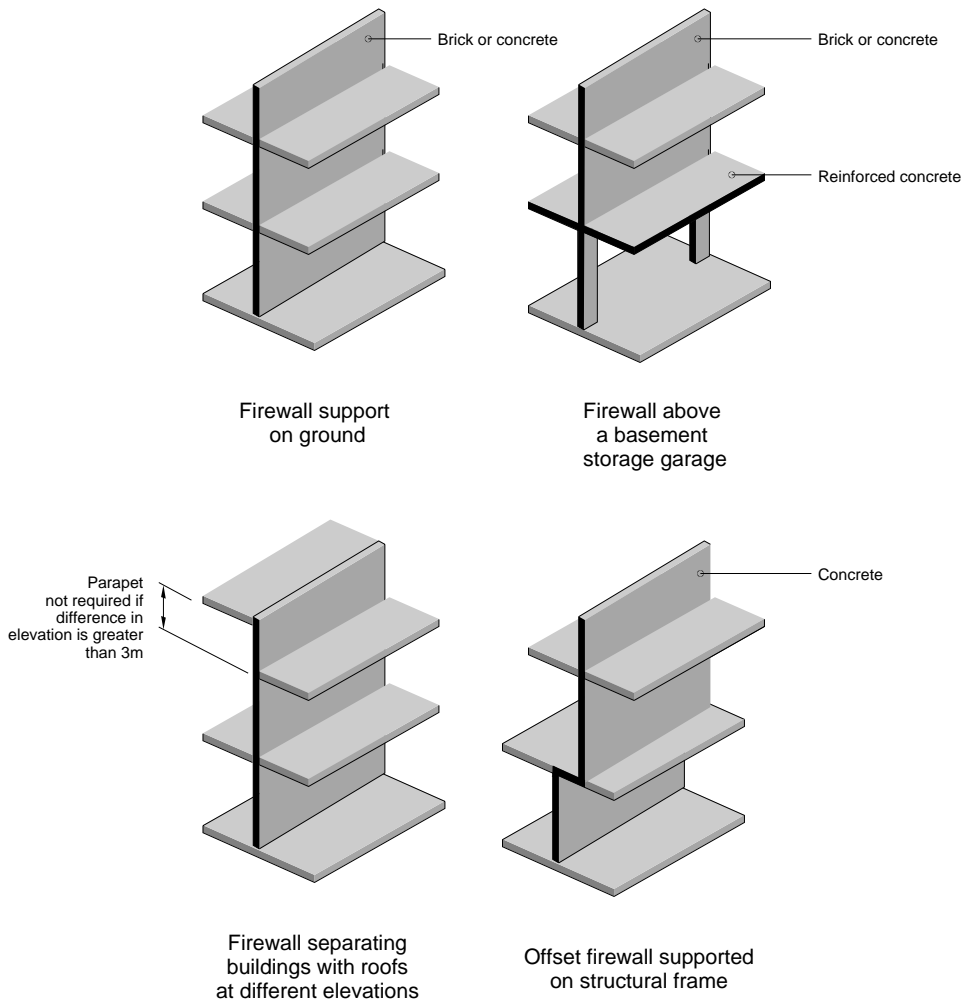

3.1.10.7. Wood construction can also be used in exterior walls with firewalls having smoke-tight joints similar to the roof-firewall intersection. To prevent flames from jumping across or around a firewall, combustible balconies, platforms, stairs, eaves or other projections are not permitted within 2.4m of similar combustible projections or window or door openings on the adjoining building.

3.1.10.4. A firewall must extend through all storeys from the basement slab up through the roof where it must form a parapet 150mm or 900mm high above the roof surface, depending on whether the wall requires a two- or four-hour rating. The parapet protects fire-fighters and prevents the fire from spreading to the other side.

3.1.10.3. The firewall may, however, terminate at the underside of a roof slab that has, on both sides, a fire-resistance rating equal to half that required for the firewall, provided there is no concealed space above. Even if a fire breaches the roof slab on one side in half the time, it will take as long for the fire to break through the slab on the other side.

3.1.10.1.(3) A firewall may also be supported on noncombustible construction having the same fire-resistance rating. This allows, for instance, parking garages to span below several building parts considered as separate buildings for the purpose of determining fire protection requirements (Figure 5.7).

3.1.10.2.(1) A firewall need not have the same fire-resistance rating throughout. In a multi-storey building with lower floor occupancies requiring a four-hour firewall and upper-floor, less hazardous occupancies requiring a two-hour firewall, the rating of the firewall separating the upper-floor occupancies can be reduced to two hours. The reverse is not allowed because construction supporting the firewall must have at least an equal rating.

3.1.10.5. Firewall openings are subject to the same size limits as fire separation openings and the aggregate width of openings cannot exceed 25% of the wall length. Openings must be protected by closures and, in the case of building services such as pipes, the gap between the wall and the penetrating component must be sealed by a fire stop system.

5.3 Fire-Resistance Ratings

Fire separations must be designed to resist the effects of fire for a given time based on its expected severity in a compartment.

Fire-resistance rating is defined in part as: “the time in hours or fraction thereof that a material or assembly of materials will withstand the passage of flame and the transmission of heat when exposed to fire under specified conditions of test and performance criteria..”

HISTORY

Since the early 1920s, the conventional way to establish fire-resistance rating has been to subject a representative sample of the construction to a standard fire test performed in special furnaces. The test methods and furnaces date back to the end of the last century.

In the late 1800s, building regulations consisted of cumbersome prescriptive requirements which specified materials and methods of assembly. These were deemed to offer an acceptable level of fire protection based on observations at fire sites. Such regulations were limiting and did not allow for innovative solutions.

Eventually, with increasing pressure from designers and manufacturers promoting new products and construction systems, researchers subjected representative floor specimens to exposure from a standard wood crib fire which lasted from eight to 24 hours.

This evaluation procedure became a standard test method across the US and was published by the American Society for Testing and Materials (ASTM) in 1908. ASTM standard test criteria were adopted by other organisations including the Underwriters’ Laboratories of Canada. They remain largely unchanged today.

FIRE-RESISTANCE TESTING

Representative samples of assemblies are tested in furnaces. Test assemblies are large enough to simulate the floor or wall enclosing a small room as follows:

- floor specimens must be almost 17m² with no side less than 3.7m
- walls must be slightly over 9m² with no dimension less than 2.75m
- building columns must be not less than 2.75m in height

Three different furnaces were developed, for walls (Fig 5.8), floors (Fig. 5.9) and columns (Fig. 5.10), to replicate the different fire exposures.

Horizontal Assemblies

3.1.7.3.(1) Horizontal assemblies such as floors, ceilings and roofs are tested for fire exposure from the underside only. This is because a fire in the compartment below presents the most severe threat. For this reason, the fire-resistance rating is required from the underside of the assembly only.



FIGURE 5.8

Fire test furnace for floors and roofs

FIGURE 5.9

Fire test furnace for walls

Horizontal assemblies, when tested, are built as the top of the furnace and are subjected to a superimposed load. This load is normally equal to the maximum allowable design load permitted by the applicable design standard. The loads are typically applied from above by hydraulic jacks. If conducted under a reduced load, the test report must include such a limitation.

Floor and roof assemblies may or may not have end restraint (lateral displacement and rotation prevented) when constructed. If the assembly is tested under restrained conditions, it offers more resistance to thermal displacements and implies additional fire resistance for the loadbearing assembly.

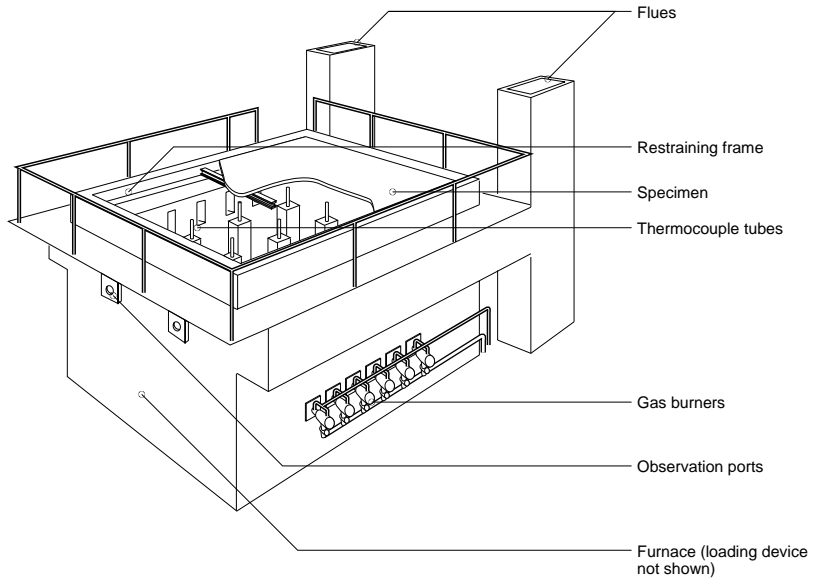
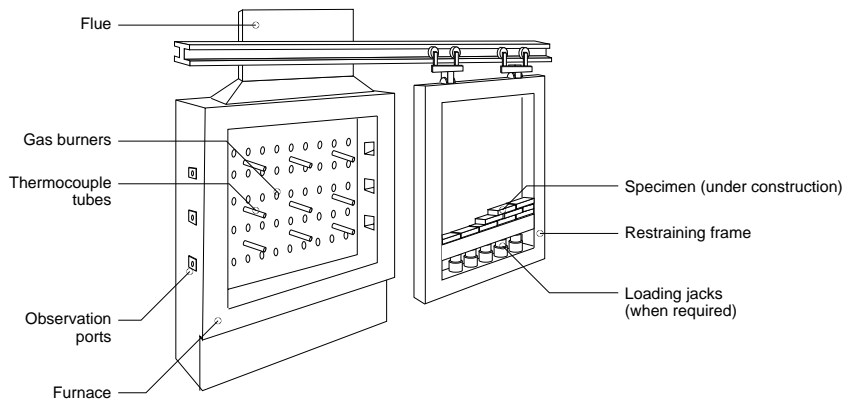
The fire-resistance rating of the tested assembly will indicate, as part of the listing limitations, the restraint conditions of the test. When selecting a fire-resistance rating, it is important to ensure that the restraint conditions of the test are the same as the construction in the field. Wood frame assemblies are normally tested with no end restraint to correspond with normal construction practice.

Vertical Assemblies

3.1.7.3.(2) Partitions or interior walls required to have a fire-resistance rating must be rated equally from each side since a fire could develop on either side of the fire separation. They are normally designed symmetrically. If they are not symmetrical, the fire-resistance rating of the assembly is determined based on testing from the weakest side.

Figure 5.9 illustrates the furnace used for testing vertical assemblies. The wall assembly forms one side of the furnace creating a closed four-sided box.

For a loadbearing wall, the test requires the maximum load permitted by design standards be superimposed on the assembly. Most wood-stud wall assemblies are tested and listed as loadbearing. This allows them to be used in both loadbearing and non-loadbearing applications. Most steel-stud wall assemblies are tested and listed as non-loadbearing because they are used primarily in non-loadbearing applications in noncombustible buildings.

Loadbearing steel-stud wall assemblies typically use studs of a heavier gauge steel than non-loadbearing studs to be able to support the load. The heavier gauge stud reacts differently when exposed to fire and withstands the tendency for studs to twist and distort when exposed to heat. Loadbearing and non-loadbearing steel stud wall listings are not interchangeable because the properties of the studs in these assemblies are not the same. Listings for loadbearing wood stud walls can be used for non-loadbearing cases since the same studs are used in both applications.

Loading during the test is critical as it affects the capacity of the wall assembly to remain in place and serve its purpose in preventing fire spread. The strength loss in studs resulting from elevated temperatures or actual burning of structural elements causes deflection. This deflection affects the capacity of the protective wall membranes (gypsum wallboard) to remain in place and contain the fire. The fire-resistance rating of loadbearing wall assemblies is typically lower than that of a similarly designed non-loadbearing assembly.

3.1.7.3.(3) Exterior walls only require rating for fire exposure from within a building. This is because fire exposure from the exterior of a building is not likely to be as severe as that from a fire in an interior room or compartment. Because this rating is required from the inside only, exterior wall assemblies do not have to be symmetrical.



3.1.7.2.(1) The acceptance criteria in the standard fire-resistance test method (see insert page 151) limits the maximum temperature rise on the unexposed face (side of tested assembly outside the test furnace). This maximum temperature rise criteria does not apply to exterior walls used where the limiting distance is 1.2m or greater.

Temperature transmission limits are specified in the test to guard against the possibility of igniting combustible materials which may be against the wall in an adjacent room. If a fire separation restricts the passage of flame but allows the temperature on its unexposed side to rise high enough to ignite combustible materials, it will not have performed its function of resisting fire spread.

This situation does not apply to an exterior wall. However, other *NBCC* requirements (in Subsection **3.2.3.**) concerning the potential increase in radiation exposure to adjacent buildings will apply in this case (Chapter 7).

If a listed wall assembly was tested with gypsum wallboard on both sides of the wall assembly, and is used as an exterior wall design, it must still be constructed exactly as tested. The requirement for a rating only from within the building, does not permit the gypsum wallboard membrane on the outside face of the wall to be omitted.

The column furnace shown in Figure 5.10 is designed to test the column under its expected service load. Usually, this is done

FIGURE 5.10

Fire test furnace for columns

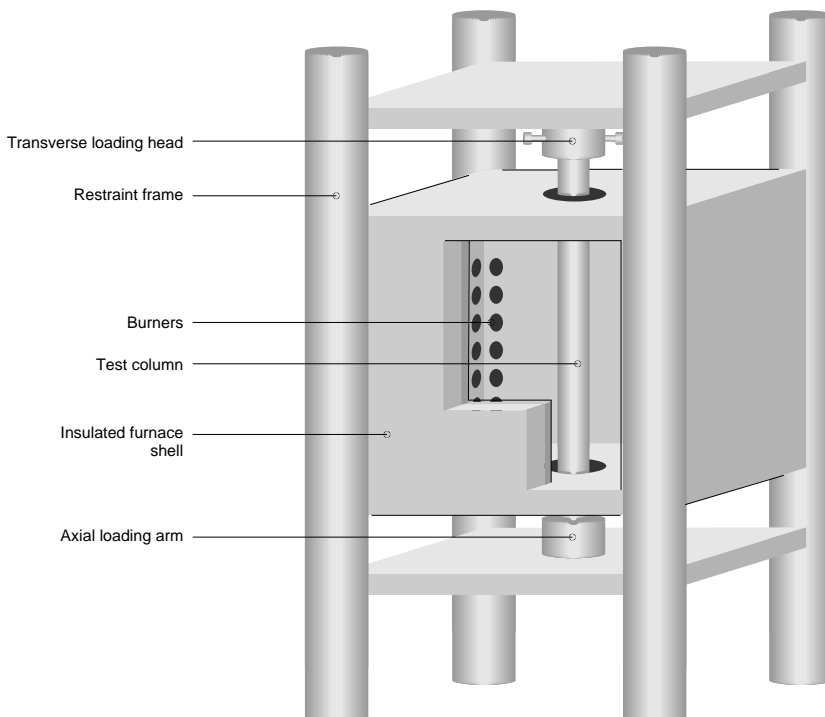

under axial loading. The furnace at the Institute for Research in Construction (IRC) in Ottawa is the only one in Canada that can test columns under eccentric loads, and expose columns to fire from all sides at the same time.

Standard Fire Test

3.1.7.1. The test and acceptance criteria the *NBCC* refers to are contained in a standard fire test method, CAN/ULC-S101, *Standard Method of Fire Endurance Tests of Building Construction and Materials*, published by Underwriters' Laboratories of Canada (see insert below).

ULC S101, Standard Method of Fire Endurance Tests of Building Construction and Materials

Criteria for testing and acceptance in this test method differ according to assembly type. The assigned fire-resistance rating for an assembly is the length of time it can withstand the standard fire exposure, based on a standard temperature-versus-time relationship (see insert page 152) while still satisfying the following criteria:

- permit no passage through the assembly of heat or flames hot enough to ignite cotton waste
- specimen to remain in place under design loads (for load-bearing assemblies only)
- temperature rise on the unexposed surface (wall or floor surface outside the test furnace) of specimen limited to 139°C (average of nine points measured) and 181°C (maximum at any point)
- no passage of hose stream through the assembly (vertical wall assemblies only).

The first two criteria are self-explanatory. The third is

intended to prevent the ignition of combustibles located directly against the unexposed floor or wall membrane in the adjacent compartment.

The hose stream criterion is only used for walls which must have a fire-resistance rating of one hour or more. This is intended to ensure a minimum resistance to the cooling and erosion effects of a hose stream that might be directed at the wall during firefighting. An assembly is first tested to determine its fire-resistance rating. A duplicate assembly is then constructed and submitted to the fire test but removed from the furnace at the half way point. The hose stream test is performed on the duplicate specimen at that point.

For loadbearing columns, the specimen need only sustain the applied load for the duration of the test. For protected steel columns, where the protection does not contribute to loadbearing, an applied load is not required, but the average temperature of the steel must not exceed 538 °C nor may the temperature at any point exceed 649 °C.



The ULC fire-resistance test may be used to establish the fire-resistance rating of a single material or an assembly of materials. Since floors and walls usually have a variety of components, the test is most frequently applied to entire construction assemblies. It

provides a relative measure of the fire resistance of the entire assembly, not that of its individual components. The fire-resistance test is designed to evaluate an assembly as a complete system, whether it is of combustible or noncombustible construction.

Standard Temperature-versus-Time Curve

In the standard fire test, the furnace temperature is controlled to follow the time/temperature curve shown here. This curve was established in 1918 using the maximum temperatures in real fires. These temperatures were determined by observing the fusion of materials with known melting points in the fires.

The curve is considered to represent average fire temperatures. Temperatures of actual fires vary according to:

- the amount, type and geometry of combustible contents in a compartment
- the availability of fresh air
- the flame-spread and thermal conductivity characteristics of finish materials on the walls and floor

Test results using this time/temperature curve are accepted as an adequate representation of the expected performance

of the assembly in a real fire. This fire exposure is felt to be severe enough to challenge the fire-safety of the assembly.

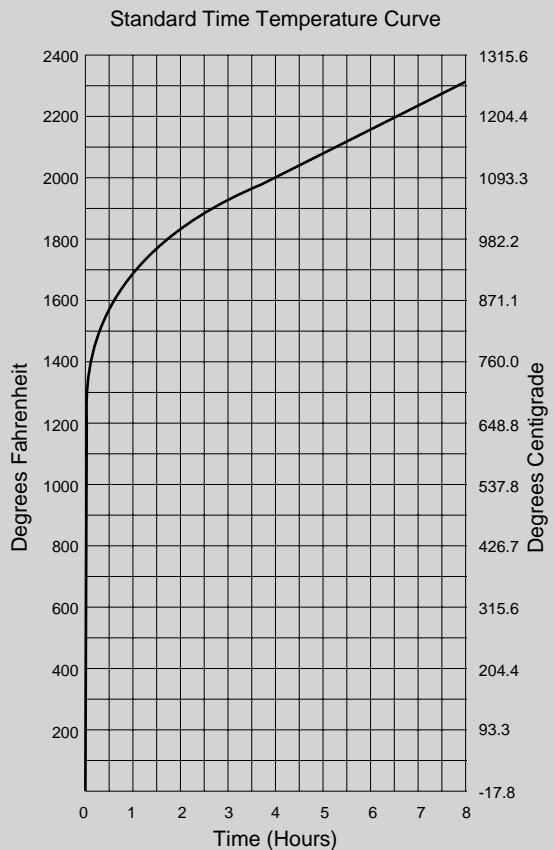

1000° F (538°C)	at 5 min
1300° F (704°C)	at 10 min
1550° F (843°C)	at 30 min
1700° F (927°C)	at 1 hr
1850° F (1010°C)	at 2 hr
2000° F (1093°C)	at 4 hr
2300° F (1260°C)	at 8 hr or over

The greatest disadvantage of the conventional test approach is that designers must conform to every essential detail of the tested assemblies to obtain the listed fire-resistance rating. Even a slight modification such as type or spacing of fasteners could mean that the fire-resistance rating is not valid.

It may be necessary to test a new specimen to ensure that the proposed modification will not reduce the fire resistance of the assembly. This can be very expensive and prevents new methods from being easily applied. There are some guidelines for extrapolation of data from fire-resistance tests which may be accepted by the authority having jurisdiction. These are detailed in Section 5.4.

AVAILABILITY OF TEST RESULTS

A multitude of fire-resistance tests have been conducted over the last 70 years by North American laboratories. Results are available through:

- Underwriters' Laboratories of Canada
- Warnock Hersey Professional Services Ltd.
- Underwriters' Laboratories Incorporated
- Factory Mutual Research Corporation

In addition, manufacturers of construction products publish results of fire-resistance tests on assemblies incorporating their proprietary products

(for example, Gypsum Association's *Fire Resistance Design Manual*). (The addresses for these references are listed in the Information Source of the Appendix).

Testing laboratories and manufacturers also publish information on proprietary listings of assemblies which describe all materials used and assembly methods. Figures 5.11 and 5.12 reproduce information from one of these sources.

The listings are useful because they offer off-the-shelf solutions to designers. They can, however, restrict innovation because designers use assemblies which have already been tested rather than pay to have new assemblies evaluated. Listed assemblies must be used with the same materials and installation methods as those tested.

A-9.10.3.1.A A recent research project at NRC resulted in over one hundred different wall assemblies being assigned fire-resistance and sound transmission ratings. These results are published in *NBCC Table A-9.10.3.1.A*. Not all assemblies described were actually tested. The fire-resistance ratings for some assemblies were extrapolated from fire tests done on similar wall assemblies.

Although there is no direct reference to *Table A-9.10.3.1.A* in Part 3, the fire-resistance ratings listed have been determined on the basis of tests conducted in accordance with the ULC-S101 standard referenced in Part 3.

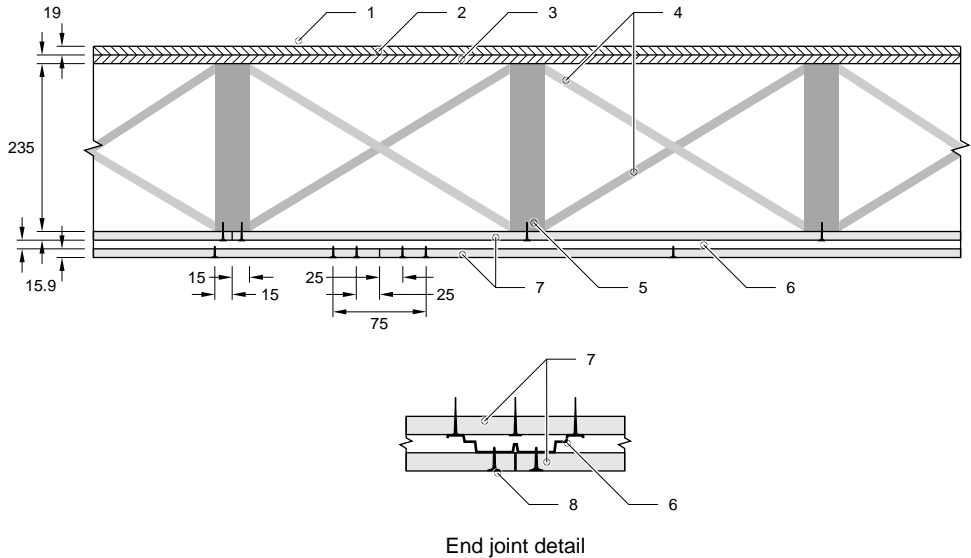

FIGURE 5.11

Listed wood joist floor assembly

Design No. M503 Unrestrained Assembly Rating: 2h

Combustible Construction
(Finish Rating - 75 minutes)

1. Finish Flooring: 19 x 89mm T & G flooring laid perpendicular to joists or 15.5mm select sheathing grade T & G phenolic bonded Douglas Fir plywood with face grain perpendicular to joists and joints staggered.
2. Building Paper (optional): Commercial sheathing material, 0.25mm thick.
3. Sub-flooring: 19 x 140mm T & G boards laid diagonally to joists or 12.5mm unsanded sheathing grade phenolic bonded Douglas Fir plywood with face grain perpendicular to joists and joints staggered.
4. Bridging: 19 x 64mm.
5. Wood Joists: 38 x 235mm spaced 400mm O.C., firestopped.
6. Furring Channel: Resilient, formed of 0.5mm electrogalvanized steel as shown, spaced 600mm O.C. perpendicular to joists. Channels overlapped at splice 38mm and fastened to each joist with 63mm common nails. Minimum clearance of channels to walls, 20mm. Additional pieces 1500mm long placed immediately adjacent to channels at end of joints of second layers; ends to extend 150mm beyond each side of end joint.
7. Gypsum Wallboard: (Guide No. 40U18.23). 15.9mm thick, 1200mm wide. First layer of wallboard installed with long dimension perpendicular to joists and end joints of boards located at the joists. Nailed to joists with uncoated 63mm box nails spaced 180mm O.C. All nails located 15mm minimum distance from the edges and ends of the board. Second layer of wallboard secured to furring channels by 25mm long wallboard screws. Second layer installed with long dimension perpendicular to the furring channels and centre line of boards located under a joist and so placed that the edge joint of this layer is not in alignment with the end joint of the first layer. Secured to furring channels with wallboard screws 300mm O.C. with additional screws 75mm from side joints. End joints of wallboard fastened at additional furring channels as shown in end-joint detail. All screws located 25mm minimum distance from edges of boards.
ATLANTIC GYPSUM, a division of the Lundrigans-Comstock Limited
DOMTAR INC.
GEORGIA PACIFIC CORPORATION
WESTROC INDUSTRIES LIMITED
8. Wallboard screws: Type S Phillips self-drilling and self-tapping 25mm long.
9. Joint System (not shown): Paper tape embedded in cementitious compound over joints and exposed nail heads covered with compound, with edges of compound feathered out.

Reprinted by permission of Underwriters Laboratories of Canada.

FIGURE 5.12

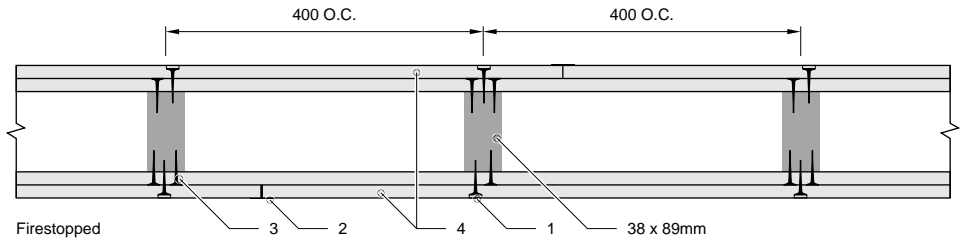
Listed wood stud wall assembly

Design No. U301 Assembly Rating: 2h

Bearing Wall - Combustible Construction
(Finish Rating - 66 minutes)

1. Nailheads: Exposed or covered with joint finisher.
2. Joints: Exposed or covered with tape and joint finisher.
3. Nails: 51mm, cement-coated flathead.
4. Gypsum Wallboard: (Guide No. 40U18.23), 15.9mm thick applied in two layers.
Base layer placed vertically with joints butted over studs and nailed to studs 150mm O.C.
Face Layer applied horizontally with joint finisher cement and nailed 300mm O.C. temporarily to base layer until cement sets.
All joints in face layers staggered with joints in base layers and with joints on opposite sides.
Canadian Gypsum Company, Limited, A division of CGC Inc.
Domtar Inc.

Reprinted by permission of Underwriters' Laboratories of Canada.

ALTERNATIVE TEST STANDARDS

The *NBCC* permits the authority having jurisdiction to accept results of tests performed according to other standards. Since test methods have changed little over the years, results based on earlier or more recent editions of the *CAN/ULC-S101* standard are comparable.

The primary US fire-resistance standard, *ASTM E119*, is very similar to the *CAN/ULC-S101* standard.

Both use the same time-temperature curve and the same performance criteria. Fire-resistance ratings developed in accordance with *ASTM E119* are usually acceptable by Canadian officials. Whether an authority having jurisdiction accepts the results of tests based on these standards depends primarily on the official's familiarity with them.

5.4 Alternative Methods for Determining Fire-Resistance Ratings

The previous chapter on fire-resistance ratings deals with the determination of fire-resistance ratings from standard tests. This chapter features alternative methods for determining fire-resistance ratings which are permitted by the second part of the fire-resistance rating definition.

Fire-resistance rating is defined as: “the time in hours or fraction thereof that a material or assembly of materials will withstand the passage of flame and the transmission of heat when exposed to fire under specified conditions of test and performance criteria **or as determined by extension or interpretation of information derived therefrom as prescribed in this Code.**”

3.1.7.1.(2) This interpretation of information from tests applies to the alternative methods of determining fire-resistance ratings as contained in the *NBCC Appendix D, Fire-Performance Ratings*. These alternative calculation methods can replace expensive proprietary fire tests. In some cases, these allow less stringent installation and design requirements such as alternate fastener details for gypsum wallboard and the allowance of openings in ceiling membranes for ventilation systems.

Section D-2 in *NBCC Appendix D* includes methods of assigning fire-resistance ratings to:

- masonry and concrete walls
- reinforced and prestressed concrete floor and roof slabs
- wood-and steel-framed walls, floors and roofs
- glue-laminated timber beams and columns
- concrete filled hollow steel columns

COMPONENT ADDITIVE METHOD

D-2.3. The most practical alternative calculation method, includes procedures for calculating the fire-resistance rating of light wood- and steel-frame wall, floor and roof assemblies based on generic descriptions of materials. This component additive method (CAM) can be used when it is clear that the fire-resistance rating of an assembly depends strictly on the specification and arrangement of materials for which nationally recognized standards exist.

CAM was developed in the early 1960s by a technical committee from an analysis of fire-test data. The estimates are conservative since the assigned ratings must apply to all systems and products covered by the material standard description. The assemblies must conform to all requirements in *NBCC Appendix D* for the rating to be valid.

3.1.7.3. The *NBCC* requires that exposure conditions for fire-resistance ratings be based on the following:

- floor, roof and ceiling assemblies shall be rated for exposure to fire on the underside



- firewalls and interior vertical fire separations shall be rated for exposure to fire on each side
- exterior walls shall be rated for exposure to fire from inside the building

For light frame assemblies, CAM relates to the fire performance of walls or partitions with fire exposure from one side only. For a floor or roof assembly, the method is based on fire performance when fire exposure is from below.

D-2.3.1. CAM can be used to assign a fire-resistance rating of up to 90 minutes.

D-2.3.2. The ratings apply to:

- non-loadbearing and loadbearing wood-stud walls and partitions
- non-loadbearing steel-stud partitions
- loadbearing wood joist and wood truss floor and roof assemblies
- open-web steel joist floor and roof assemblies

D-2.3.6.(2) CAM can be used for wood-frame floor and roof assemblies with wood joists and metal-plate connected wood trusses (both pitched and parallel chord design). Wood joists and members of trusses must not be less than 38 x 89mm.

This calculation method does not apply to assemblies incorporating wood trusses with metal-tube or bar webs, nor to wood I-joists.

Manufacturers of these products have proprietary listings of assemblies incorporating these elements with fire-resistance ratings ranging from 45 minutes to two hours.

D-2.3.6.(5) CAM cannot be used to assign fire-resistance ratings to loadbearing steel-stud wall assemblies. Light gauge steel studs used in any non-loadbearing partition or in any wall requiring a fire-resistance rating must be installed with a clearance of at least 12mm between the top of the stud and the top runner to allow for expansion in a fire. Because it may expand and twist under heat, the top of the steel stud may not be attached to the top runner by screws, welding, crimping or any other method.

D-2.3.4.(1) In applying the Component Additive Method, the fire-resistance rating of an assembly is calculated by adding:

- the time assigned to the protective membranes (wallboard or ceiling membranes) on the fire side
- the time assigned to the structural framing members
- the time allowed for membrane reinforcement, if applicable
- the time allowed for provision of some types of insulation within the assembly

D-2.3.6.(6) Although resilient and gypsum wallboard furring channels were not common when the calculation method was developed, fire research shows that the fire-resistance rating of floor

assemblies is not reduced by them. They are now permitted in floor or roof assemblies without reduction in assigned values.

Recent research at NRC on the fire-resistance rating of walls has shown that the use of resilient channels may reduce the ratings in certain applications. The current calculation method in Appendix D does not reflect this. However, the fire-resistance and acoustic ratings contained in Table A-9.10.3.1.A., are based on this latest research.

D-2.3.5.(4) Fire research shows that insulation, depending on how and where it is positioned and held in place within the floor/roof assembly, can reduce the fire-resistance values of an assembly. For this reason, a floor or roof assembly with a fire-resistance rating determined by CAM is only permitted insulation if it is installed and supported within the assembly as described in D-2.3.5.(4).

D-2.3.4. Table 5.2 lists the time the Appendix assigns to various wall membranes, based on the

ability of the membrane to stay in place during the standard fire test. The 1995 *NBCC* has removed regular gypsum wallboard, fibre-board and also asbestos cement board from the finishes permitted to be used with this method. In addition, the values assigned to Douglas fir plywood can only be used in non-loadbearing walls with mineral fibre insulation in the walls and the 15 minute credit for mineral fibre insulation does not apply.

The values for regular gypsum wallboard were removed because the minimum density requirement for regular gypsum wallboard was lowered in the revised CSA standard, CSA A82.27-M91, *Gypsum Wallboard*. Gypsum wallboard manufactured to the new minimum requirements of the standard has a lower fire-resistance than that from earlier generations. As this method permits the use of any membrane which meets the minimum requirements of the standard, the listing was removed.

TABLE 5.2

Time assigned to wallboard membranes

Description of Finish	Time, minutes
11.0mm Douglas fir plywood phenolic bonded	10 ¹
14.0mm Douglas fir plywood phenolic bonded	15 ¹
12.7mm Type X gypsum wallboard	25
15.9mm Type X gypsum wallboard	40
Double 12.7mm Type X gypsum wallboard	80 ²

Notes:

1. Non-loadbearing walls only, stud cavities filled with mineral wool conforming to CSA A101-M, *Thermal Insulation, Mineral Fibre, for Buildings* and having a mass of not less than 2kg/m², with no additional credit for insulation according to Table D-2.3.4.D.
2. This value applies to non-loadbearing steel framed walls only.

Source: Appendix D, *National Building Code of Canada*, 1995, Table D-2.3.4.A.



There are still many proprietary listings which specify regular gypsum wallboard of particular manufacturers. These products are above the minimum standards and can still be used. The removal of the minimum density requirements did not affect the time assigned to Type X gypsum wallboard. The recent fire research at NRC did result in new fire-resistance ratings being assigned to wood stud wall assemblies protected by regular gypsum wallboard in **TABLE A.9.10.3.1.A**.

D-2.3.4.(3) Table 5.3 lists the times assigned to various structural framing members. These times are based, in part, on the time to structural failure of unprotected assemblies in a fire test. This recognises that the structural components stay in place for some time after the wallboard falls away.

While wood stud framing at 400mm o.c. is assigned a value of 20 minutes, a value of 15 minutes for wood studs spaced at 600mm o.c. has been added in the 1995 *NBCC* based on fire tests that were performed at NRC in the

late 1980's. The latest research performed in 1994 and 1995 at NRC resulted in identical fire-resistance ratings being assigned to wood stud walls with studs at either 400 or 600 mm o.c. This is reflected in the listings contained in **TABLE A.9.10.3.1.A**.

D-2.3.5.(1) For fire-resistance rated interior partitions, the *NBCC* requires ratings from both sides. CAM assumes that the wall assembly will be symmetrical in design with equivalent membrane protection on each side. If the membranes differ, the fire-resistance rating must be determined on the basis of the membrane assigned the lowest time.

The membrane(s) on the non-fire exposed side of the assembly is not considered to contribute to the fire-resistance rating because it is assumed that this unexposed membrane will collapse when the framing fails. This applies for all assemblies calculated with this method, whether it is a partition, floor, roof, or exterior wall.

TABLE 5.3

Time assigned for contribution of wood or light steel frame

Description of Frame	Time Assigned to Frame minutes
Wood studs max. 400mm o.c. (Loadbearing or non-loadbearing)	20
Wood studs max. 600mm o.c. (Loadbearing or non-loadbearing)	15
Steel studs max. 400mm o.c. (non-loadbearing)	10
Wood floor and roof joists max. 400mm o.c.	10
Open web steel joist floors and roofs with ceiling supports max. 400mm o.c.	10
Wood roof and floor truss assemblies max. 600mm o.c.	5

Source: Appendix D, *National Building Code of Canada*, 1995, Table D-2.3.4.C.

D-2.3.3.(3) Although Harmathy's *Ten Rules of Fire Endurance*, (see end of Section 5.4) would suggest that it is appropriate, the times assigned to individual membranes from Table 5.2 can not be added to achieve a higher overall fire-resistance rating. The recent NRC research project did result in values being assigned to assemblies with multiple and asymmetrical membrane combinations.

3.1.7.3.(3) & D-2.3.5.(2) Exterior walls are rated for exposure to fire from the interior side. They do not have to be symmetrical but must meet the following conditions to use this method:

- the exterior membrane must consist of sheathing and exterior cladding
- the spaces between the studs must be filled with insulation conforming to CSA A101-M, *Thermal Insulation, Mineral Fibre, for Buildings*, having a mass of not less than 1.22kg/m²

The mineral fibre insulation can be either manufactured from rock slag (Rockwool) or from glass fibres (fibreglass). The values assigned in Table D-2.3.4.D can still be used to increase the assigned fire-resistance rating of the exterior wall assembly.

As noted earlier, CAM cannot be used for loadbearing steel-stud exterior walls requiring a fire-resistance rating. A listed fire-rated steel-stud assembly must be used which, in many cases, requires gypsum wallboard on both the interior and exterior faces of the wall assembly.

D-2.3.5.(3) For floor and roof assemblies rated on the basis of fire exposure from below, the upper membrane (subfloor/finish floor; roof deck/covering) must consist of :

- one of the combinations listed in Table 5.4, or
- a membrane in Table 5.2 assigned at least 15 minutes

These upper membranes are assumed to provide the minimum fire resistance necessary to maintain the assembly until structural collapse. In the case of 14mm Douglas fir plywood in Table 5.2., the requirement for insulation does not apply when it is used as a floor or roof membrane.

D-2.3.12 In using CAM to determine the fire-resistance rating of a floor or roof assembly, a designer may choose a ceiling membrane that contributes all of the rating. The times assigned to gypsum wallboard and other membranes differ where the fire-resistance rating of a floor or roof assembly is determined based on the contribution of the ceiling membrane only, rather than on the complete assembly. Table 5.5 lists these values.

D-2.3.6.(1) Values listed in Tables 5.2 and 5.5 are for use in assigning a fire-resistance rating to an assembly using only the framing members described in Table 5.3. It is not intended to permit any type of framing member to be used with this approach of having the membrane



TABLE 5.4

Flooring or roofing over wood, cold formed steel members or open-web steel joists

Type of Assembly	Structural Members	Subfloor or Roof Deck	Finish Flooring or Roofing
Floor	Wood or steel joists and wood trusses	12.5mm plywood or 17mm T & G softwood	Hardwood or softwood flooring on building paper Resilient flooring, parquet floor, felted-synthetic-fibre floor coverings, carpeting or ceramic tile on 8mm thick panel-type underlay Ceramic tile on 30mm mortar bed
	Steel joists	50mm reinforced concrete or 50mm concrete on metal lath or formed steel sheet, or 40mm reinforced gypsum-fibre concrete on 12.7mm gypsum wallboard	Finish flooring
Roof	Wood or steel joists and wood trusses	12.5mm plywood or 17mm T & G softwood	Finish roofing material with or without insulation
	Steel joists	50mm reinforced concrete or 50mm concrete on metal lath or formed steel sheet, or 40mm reinforced gypsum-fibre concrete on 12.7mm gypsum wallboard	Finish roofing material with or without insulation

Source: Appendix D, 1995 NBCC, Table D-2.3.5.

TABLE 5.5

Fire-resistance rating for ceiling membranes

Description of Membrane	Fire-Resistance Rating, minutes
15.9mm Type X gypsum wallboard with at least 75mm mineral wool batt insulation above wallboard	30
19mm gypsum-sand plaster on metal lath	30
Double 14.0mm Douglas Fir plywood phenolic bonded	30
Double 12.7mm Type X gypsum wallboard	45
25mm gypsum-sand plaster on metal lath	45
Double 15.9mm Type X gypsum wallboard	60
32mm gypsum-sand plaster on metal lath	60

Source: Appendix D, 1995 NBCC, Table D-2.3.12.

protection provide all the required fire-resistance rating.

NBCC Appendix D contains additional specific details on important features such as fastener spacing and minimum penetration, as well as the orientation and joint support required for gypsum wallboard panels.

D-2.4. CAM assigns fire-resistance ratings for solid-wood floors, walls and roofs. This is useful when dealing with existing buildings with heavy timber construction elements.

D-2.3.10. and D-2.3.11. Tests show that incorporating minor ventilation openings in the ceiling

membrane does not significantly reduce the fire-resistance rating assigned to the assembly. In floor and roof assemblies assigned a fire-resistance rating using CAM, duct openings are permitted in the ceiling membranes providing size, location, thermal protection and other factors conform to the requirements in Appendix D.

D-2.3.12. Such openings are not allowed where the assigned fire-resistance rating of the floor assembly is derived entirely from the ceiling membrane.

Following are example applications of the Component Additive Method:

Example 5.3

Determine the fire-resistance rating of an interior partition with 12.7mm Type X gypsum wallboard (GWB) on both sides of wood studs spaced at 400mm o.c. This assembly may be loadbearing or non-loadbearing.

From Table 5.2: (**D-2.3.4.A**)

Time assigned to 12.7mm Type X GWB	25
------------------------------------	----

From Table 5.3: (**D-2.3.4.C**)

Time assigned to wood studs	20
-----------------------------	----

Fire-resistance rating of interior partition:	<u>45 minutes</u>
---	-------------------

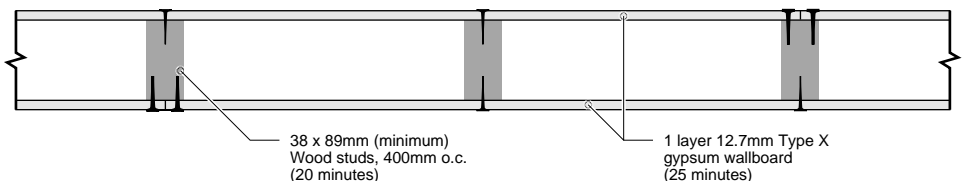

Example 5.4

Determine the fire-resistance rating of a wood stud exterior wall assembly with 15.9mm Type X gypsum wallboard on the interior side and plywood sheathing and wood shingle siding on the exterior with the studs spaced at 400mm o.c.

From Table 5.2: (**D-2.3.4.A**)

Time assigned to 15.9mm Type X GWB	40
------------------------------------	----

From Table 5.3: (**D-2.3.4.C**)

Time assigned to wood studs	20
-----------------------------	----

Fire-resistance rating of exterior wall:	<u>60 minutes</u>
--	-------------------

D-2.3.5.(2) Mineral Fibre insulation having a mass of not less than 1.22 kg/m² of wall surface is required to be installed in stud cavities.

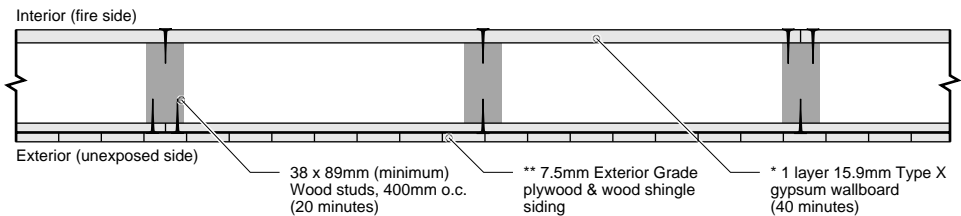

Notes to Example 5.4:

* If the wall cavity is insulated with Mineral Fibre insulation of rock fibres (not fibreglass) having a mass of not less than 1.22 kg/m² of wall surface (15 minutes assigned contribution) Type X gypsum wallboard could be 12.7mm thick (25 minutes) and still retain 1 hour assigned fire-resistance rating.

** This combination could be replaced by any sheathing and exterior cladding.

Example 5.5

Determine the fire-resistance rating of a wood truss floor assembly with a ceiling of 15.9mm Type X gypsum wallboard and trusses spaced at 600mm o.c.

From Table 5.2: (**D-2.3.4.A**)

Time assigned to 15.9mm Type X gypsum wallboard 40

From Table 5.3: (**D-2.3.4.C**)

Time assigned to wood trusses 5

Fire-resistance rating of wood truss floor assembly: 45 minutes

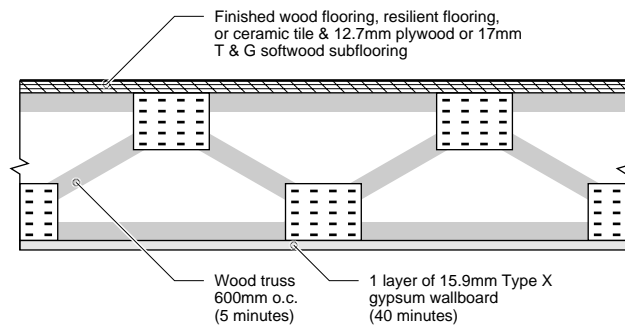
**Example 5.6**

Determine the fire-resistance rating of a wood joist floor assembly with a ceiling of 2 layers of 15.9mm Type X gypsum wallboard and joists spaced at 400mm o.c.

Table 5.2 has only single layer applications or 15.9mm Type X for wood framing therefore must use resistance of ceiling membrane only

From Table 5.5 (**TABLE D-2.3.12**):

Time assigned to two layers of 15.9mm Type X gypsum wallboard 60

Fire-resistance rating of wood joist floor assembly: 60 minutes

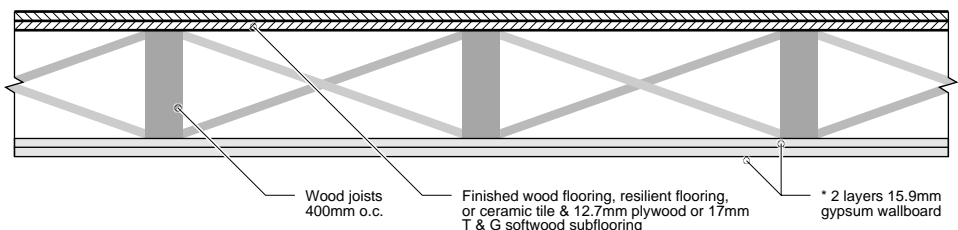
**Notes to Example 5.6:**

* No openings would be permitted in the ceiling membrane.

FIRE AND SOUND RESISTANCE TABLES

TABLES A.9.10.3.1.A and A.9.10.3.1.B .

These tables contain sound transmission and fire-resistance ratings on typical wall and floor assemblies respectively. These have been changed extensively in the 1995 *NBCC*. This significant revision was precipitated by two important factors:

- The 1990 *NBCC* increased the minimum sound transmission classification (STC) ratings required between residential suites from 45 to 50 and between suites and vertical shafts from 50 to 55.
- The CSA Standard, CSA A82.27-M1977 *Gypsum Wallboard* was changed to drop the minimum density requirements for gypsum wallboard. As well, the definition of Type X gypsum wallboard was revised from being based on performance with loadbearing wood stud walls to being qualified on the basis of performance on a non-loadbearing steel stud partition.

These changes to the CSA gypsum standard raised questions as to the minimum performance expectations for sound transmission and fire-resistance ratings on generic new generation gypsum wallboard products for both ordinary and fire-rated boards.

Research Project

A joint NRC/industry research project on the fire and sound performance of walls resulted in information on these new gypsum

wallboard products manufactured to the new standard. A broader list of assemblies that could meet the new minimum STC ratings in the *NBCC* was developed.

The project involved two studies, one on acoustical performance and the other on fire resistance of wall assemblies. Complete wall systems were tested to examine how the acoustic and fire performance were affected by the following:

- resilient channel installation
- type of insulation
- type, density and thickness of gypsum wallboard
- stud type and arrangement (single, staggered, double)

To develop information on a generic basis for different wall assemblies, the assemblies were tested using:

- minimum construction requirements in the Code such as fasteners spacing, location of unbacked joints, lightweight ordinary gypsum wallboard
- maximum design loads in the case of loadbearing wood stud wall assemblies

The resulting tables would therefore apply to all wood stud wall systems and non-loadbearing steel stud wall systems that were constructed to the requirements of the *NBCC*.

In the fire-resistance portion of the project, loadbearing and non-loadbearing wood stud walls were tested with single, double and staggered stud arrangements. Only non-loadbearing steel studs in a single row were tested.

For assessing acoustical performance, all of the forementioned assemblies and also loadbearing steel stud systems were tested.

Research Results

The wall research project resulted in the following observations and conclusions:

Stud type and arrangement:

In the non-load-bearing tests, wood stud assemblies provided a slightly better fire-resistance rating than steel stud assemblies. (load-bearing steel stud assemblies were not tested for fire resistance).

Staggered studs and double rows of wood studs on separate plates provided significant increases in STC without decreasing the fire-resistance rating.

Resilient channels:

The use of resilient channels (RC) increased the STC.

Increasing the spacing of the RC increased the sound rating over closely spaced channels.

The use of RC under single layers of gypsum wallboard decreased the fire-resistance rating while the installation of the RC under double layers increased the fire-resistance rating.

Insulation:

The installation of glass fibre or cellulose fibre insulation did not negatively affect the fire-resistance rating when compared to an uninsulated assembly.

The provision of mineral fibre insulation increased the fire-resistance rating significantly. The tightness of the installation of these batts was a major contributor to this increased rating.

Gypsum wallboard:

The changes to the gypsum standard permitting lower densities for regular gypsum wallboard had an adverse effect on the fire-resistance rating. Lower density gypsum wallboard had a lower fire-resistance rating than higher density gypsum wallboard. Ordinary gypsum wallboard with glass fibre in the core had better fire performance than the gypsum wallboard without glass fibre.

Two layers of gypsum wallboard significantly increased the fire resistance rating in comparison with single layer application.

Code Changes

A-9.10.3.1.A The results of the Wall Project were used to develop a new Table A-9.10.3.1.A— *Fire and Sound Resistance of Walls* in the 1995 *NBCC* with a significant increase in the number of listings. This allows designers much more choice and flexibility in meeting the requirements for fire and sound performance set out by the *NBCC*.

Although Part 3 does not directly reference Table A.9.10.3.1.A., the fire-resistance ratings listed were determined on the basis of tests conducted with the *NBCC* referenced fire standard, ULC-S101. A majority of the listings are based on actual tests while some of the



values have been conservatively extrapolated, especially the FRR's.

A-9.10.3.1.B The reduction in the fire-resistance rating of the gypsum wallboard manufactured to the lower densities now permitted by the gypsum standard resulted in the removal of all reference to regular gypsum wallboard in Table A.9.10.3.1.B – *Fire and Sound Resistance of Floors*. Floor and roof assemblies using only Type X gypsum wallboard are referenced in the 1995 *NBCC*.

CALCULATING FIRE RESISTANCE OF GLULAM TIMBERS

NBCC Appendix D also includes empirical equations for calculating the fire-resistance rating of glue-laminated (glulam) timber beams and columns, as well as concrete and steel members. These equations were developed from theoretical predictions and validated by test results.

Large wood members have an inherent fire resistance because:

- the slow burning rate of large timbers, approximately 0.6 mm/minute under standard fire test conditions
- the insulating effects of the char layer which protects the unburned portion of the wood

These factors result in unprotected members that can stay in place for a considerable time when exposed to fire. The *NBCC* recognizes this characteristic and allows unprotected wood members including floor and roof decks, which meet the minimum sizes for heavy

timber to be used both where a 45 minute fire-resistance rating is required and in many noncombustible buildings (Chapter 4).

D-2.11.2. Provisions for calculating the fire-resistance rating of glulam beams and columns are based on data from tests on timber beams and columns. This calculation method determines a fire-resistance rating for beams and columns based on exposure to fire from three or four sides. Using this approach, the fire-resistance rating (FRR) in minutes of glulam beams and columns is

$$\text{FRR} = 0.1fB \left[4 - 2\frac{B}{D} \right]$$

for beams exposed to fire on 4 sides,

$$\text{FRR} = 0.1fB \left[4 - \frac{B}{D} \right]$$

for beams exposed to fire on 3 sides,

$$\text{FRR} = 0.1fB \left[3 - \frac{B}{D} \right]$$

for columns exposed to fire on 4 sides,

$$\text{FRR} = 0.1fB \left[3 - \frac{B}{2D} \right]$$

for columns exposed to fire on 3 sides,
where

- f = the load factor shown in Figure 5.13 to compensate for partial loading
- B = the full dimension of the smaller side of the beam or column in mm before exposure to fire as shown in Figure 5.14

FIGURE 5.13

Load factor for glulam fire-resistance calculations (NBCC, 1995)

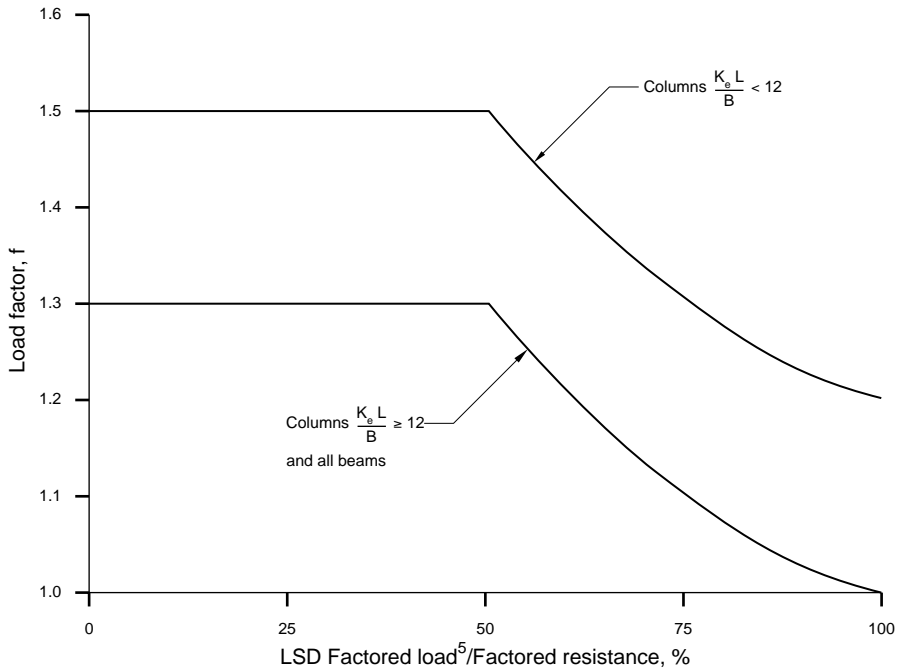

Notes:

1. K_o = Effective length factor
2. L = Unsupported length of a column in mm
3. B = Smaller side of a beam or column in mm (before fire exposure)
4. LSD = Limit States Design
5. In the case of beams, use factored bending moment in place of factored load.

D = the full dimension of the larger side of the beam or column in mm before exposure to fire as shown in Figure 5.14

The formula for columns or beams which may be exposed on three sides applies only when the unexposed face is the smaller side of a column; no experimental data exists to verify the formula when a larger side is unexposed. If a column is recessed into a wall or a beam into a floor, the full dimensions of the structural member are used in the formula for exposure to fire on three sides (Figure 5.14).

Comparisons of the calculated fire-resistance ratings with

experimental results show the calculated values are very often conservative. Some cases have resulted in the fire-resistance being underestimated by almost 30 percent. The predictions can be considered reasonably accurate. (see insert page 171)

A designer may determine the factored resistance for a beam or column by referring to CSA Standard CAN/CSA-O86.1-M94 *Engineering Design in Wood* or the 1995 Canadian Wood Council's *Wood Design Manual*.

An example of fire-resistance calculation of glulam beam is shown on the following page.

FIGURE 5.14

Glulam exposure cases
(NBCC Appendix D, 1995)

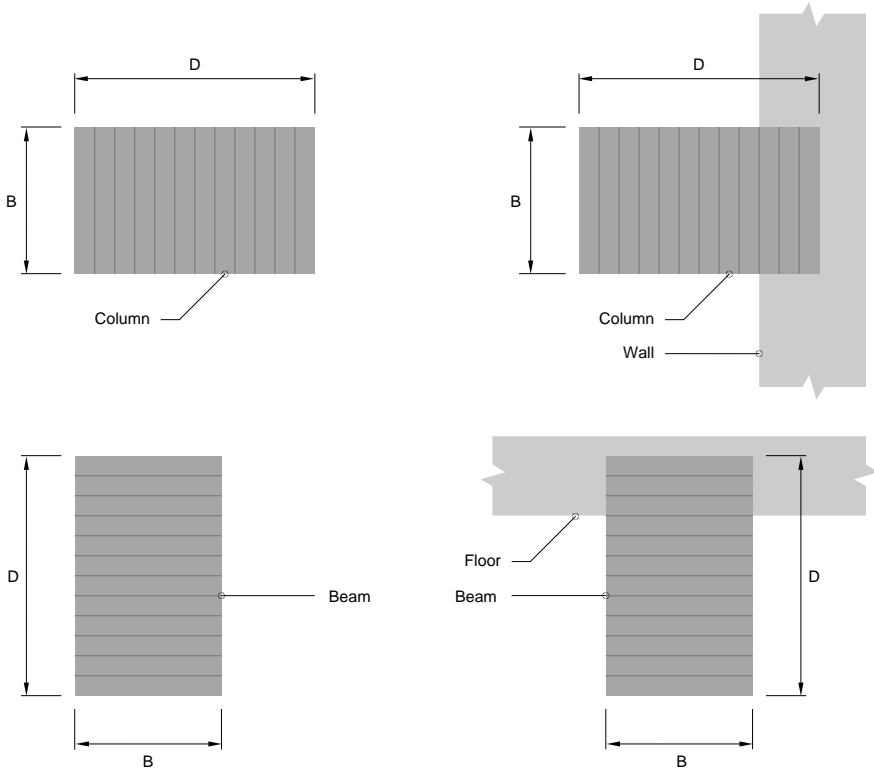

Example 5.7:

Determine the fire-resistance rating of a glulam beam exposed on three sides having dimensions of 175 x 380mm and with a factored bending moment equal to 80 percent of its bending moment resistance.

$$B = 175\text{mm}$$

$$D = 380\text{mm}$$

From Figure 5.13, $f = 1.075$ for a beam designed to carry a factored load producing 80 percent of factored bending moment resistance.

$$t = 0.1fB \left[4 - \frac{B}{D} \right]$$

$$t = 0.1 \times 1.075 \times 175 \times \left[4 - \frac{175}{380} \right]$$

Total fire-resistance rating = 66.6 minutes.

This beam could be used to support a one hour fire-resistance rated wood frame floor assembly such as the one shown in the Example 5.6 calculation earlier using the component additive method.

Correlation of Calculation Method and Fire Test

In December 1982, a glulam Douglas fir beam, with an actual size of 8-11/16 in. by 16-7/16 in. was tested in the US by the National Forest Products Association (Now the American Forest and Paper Association) using the ASTM E-119 criteria.

Clear span of the beam = 16' 6-1/4".

Design span (including 1/2 of bearing length) = 203.625"

Loading:

It was loaded at the centre and quarter span points with beam ends restrained to prevent rotation.

Point load (live) = 6,436 lbs.

Uniformly distributed load (dead, self-weight) = 2.892 lbs/in

Moment = 670,256 in-lbs

Applied stress = 1713 psi

Allowable stress = 2396.5 psi

Applied/Allowable = 71.5%

Using the formulas from Appendix D, the calculated fire-resistance rating of the beam is determined as follows:

$F(\text{applied load, allowable load}) = F(1713, 2396.5) = 71.5 \text{ percent}$ and $f = 1.125$ (from Figure 5.13).

Converting dimensions to metric values:

$B = 220.7 \text{ mm,}$

$D = 417.5 \text{ mm}$

$R = 0.1 \text{ fB } (4 - B/D)$

$= 0.1 (1.125) (220.7)$
 $(4 - (220.7/417.5))$

$= 86.2 \text{ minutes or } 86 \text{ minutes}$
 12 seconds.

Actual failure under fire endurance test: 86 minutes 15 seconds.

FIRE MODELLING

The use of computer fire endurance models is an alternative method for determining fire resistance and also fire safety. As building codes throughout the world move toward a performance-based approach and away from the prescriptive approach, fire models will become an important tool for evaluating the safety of different systems.

These fire-endurance models are based on:

- the characterization of the expected fire severity using a fire-growth model

- the determination of the heat transmission to the building elements using a heat transfer model
- an evaluation of the strength and deformation characteristics of structural members at elevated temperatures using a modified structural model

Forintek Canada Corporation developed and is refining a fire endurance model. This model has been verified and refined using data from the research that was used to produce the new fire-resistance ratings for walls in Table A.9.10.3.1.A.

At the time of testing, the assemblies were equipped with additional thermocouples and deflection gauges to characterize the heat transfer within and through the assemblies and the resultant structural response. This data is being used to validate these new computer models.

For the time being, use of these models is limited to researchers and skilled professionals in the fire protection field. Some models have already been used by fire protection professionals to show equivalent levels of safety. It is likely that expert systems will eventually be developed for use in design offices.

Studies on the pyrolysis and combustion of wood products as well as the strength of wood at elevated temperatures is also leading to the development of models that can calculate the fire-resistance rating of unprotected wood assemblies. These models predict char depth, temperature distribution in the unburned parts and strength properties of wood at elevated temperatures.

The development, use and acceptance of computer models will give designers the flexibility that is not present in the current system of prescribed requirements. Changes to an assembly could be evaluated by computer rather than having to perform a full scale fire-resistance test which can cost up to \$20,000. This will allow for more innovation in the design and construction of buildings.

The *NBCC* is currently developing an objective based code with a target release date of 2001. This would set performance objectives that buildings and building systems must meet. Computer modelling could then be used as a tool to evaluate systems against the performance criteria.

EXTRAPOLATION OF DATA FROM FIRE-RESISTANCE TESTS

Several documents have been written about extrapolation of information from fire test results. Dr. Tibor Harmathy's *The Ten Rules of Fire Endurance* provides guidance on the impact made on the fire-resistance rating of materials and assemblies when the original product or assembly is altered in some way.

Harmathy's document provides a means of assessing the fire endurance of various assemblies since it is impossible to test, prior to use, all assemblies used today. It was used to develop the *NBCC* Component Additive Method in the 1960s and to develop the values listed in Table A-9.10.3.1.A.

Harmathy's 10 rules are:

Rule 1

The thermal fire endurance of a construction consisting of a number of parallel layers is greater than the sum of the thermal fire endurance characteristics of the individual layers when exposed separately to a fire.

Rule 2

The fire endurance of a construction does not decrease with the addition of further layers.

Rule 3

The fire endurance of constructions that contain continuous air gaps or cavities is greater than the fire endurance of similar constructions of the same weight, but containing no gaps or cavities.

Rule 4

The farther an air gap or cavity is located from the exposed surface, the more beneficial is its effect on fire endurance.

Rule 5

The fire endurance of a construction cannot be increased by increasing the thickness of a completely enclosed air layer.

Rule 6

Layers of materials of low thermal conductivity are better utilized on the side of the construction on which fire is more likely to occur.

Rule 7

The fire endurance of asymmetrical constructions depends on the direction of heat flow.

Rule 8

The presence of moisture, if it does not result in explosive spalling, increases fire endurance.

Rule 9

Load-supporting elements, such as beams, girders and joists, yield higher fire endurance when subjected to fire endurance tests as part of a floor, roof, or ceiling assembly than they would when tested separately.

Rule 10

The load-supporting elements (such as beams, girders, joists) of a floor, roof or ceiling assembly can be replaced by such other load-supporting elements that, when tested separately, yield fire-endurance ratings of not less than that of the assembly.

Figure 5.15 illustrates the 10 rules. The rules are not intended to replace more accurate design approaches but may help in evaluating minor changes to the components of tested assemblies.

A ULC publication, *Criteria for Use in Extension of Data from Fire Endurance Tests* (ULC Subject C263(e)-M1988) is based in part on Harmathy's rules. Based on engineering evaluations, it discusses how changes to an assembly impact its fire-resistance rating.

The impact of, for example, the addition of insulation in an assembly, a change in thickness of a protective wallboard, or the use of different fasteners are all addressed. The ULC document is useful in determining whether or not an altered assembly can meet *NBCC* fire-resistance rating requirements.

A ULC task group is now drafting another ULC document, which will provide quantitative methods for calculating fire resistance of structures of all construction types. A third ULC document will address methodologies that incorporate computer fire models for calculating fire resistance empirically.



FIGURE 5.15

Harmathy's ten rules of fire endurance

t = Fire Endurance

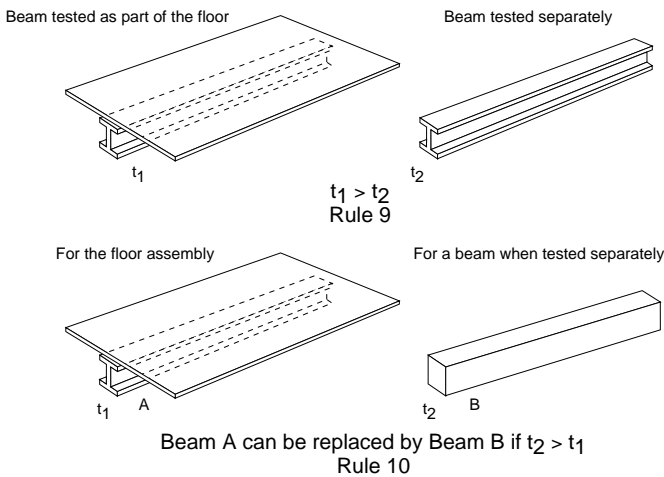
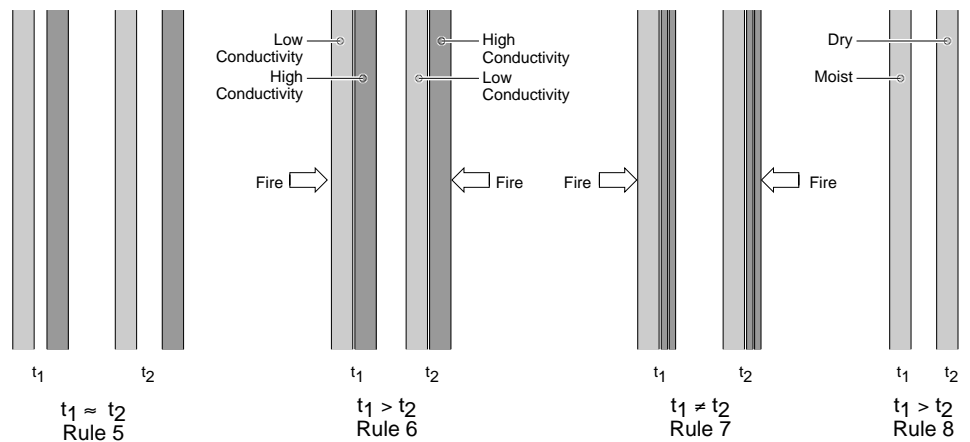
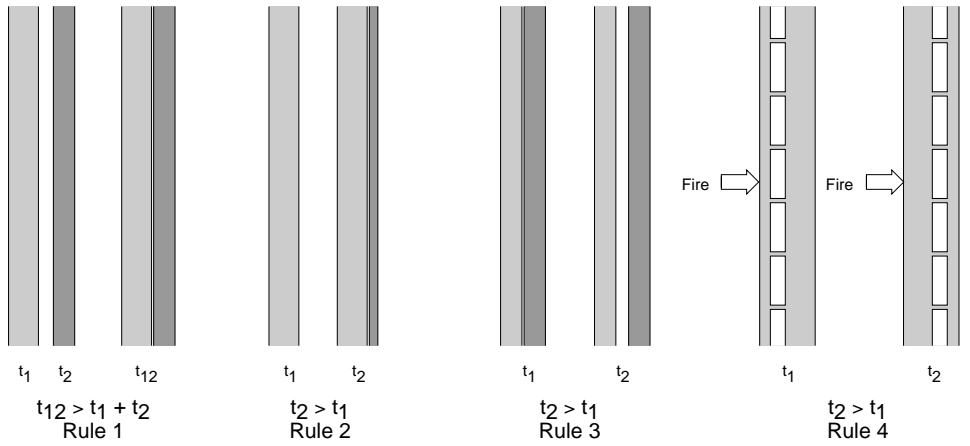

5.5 Fire-Resistance Rating Requirements in the NBCC

HISTORY

Minimum fire-resistance ratings for the major structural assemblies of a building, as specified in Chapter 3.2 of the NBCC, were partly determined on the basis of Ingberg's fire load concept developed in the 1920s.

Ingberg's theory is based on:

- the length of time required for a real fire to consume all combustible contents within a floor area and the maximum temperatures reached in a fire (time-temperature curve)
- the severity of a real fire being equal to that of the standard fire exposure over a specified time if the area under the curve representing the time/temperature history of a real fire were equal to that under the standard time/temperature curve

In the case shown, (Figure 5.16) the area under the time-temperature curve for the real fire is equal to the area under the standard fire test at 45 minutes. Therefore, the real fire is seen to be equivalent to an exposure of 45 minutes in the standard fire test. Based on Ingberg's approach, a 45-minute fire-resistance rating should be provided for an assembly enclosing a fire compartment in a building containing the occupancy represented by the fire exposure in Curve B.

Ingberg used the fire load or combustible content to develop the expected time/temperature curves (fire severity). The area under these curves were then compared to the area under the standard time temperature curve and fire-severity equivalents were assigned to various fire loads (Table 5.7).

FIGURE 5.16

Ingberg's hypothesis on equal fire severities

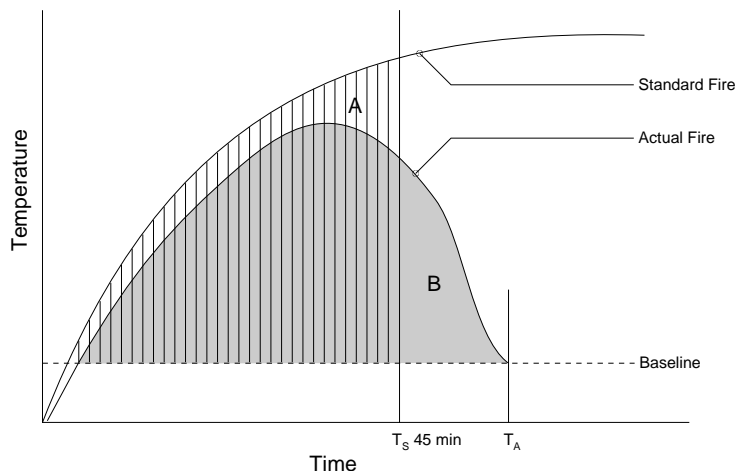

TABLE 5.6

Fire severity based on fire load concept

Fire Load of Occupancy kg/m ² (lb/ft ²)		Fuel Load Mj/m ² (BTUs/ft ²)		Equivalent Fire Severity (Standard T/T Curve), minutes
24.4	(5)	456	(40,000)	30
48.8	(10)	912	(80,000)	60
73.2	(15)	1368	(120,000)	90
97.6	(20)	1824	(160,000)	120
146.5	(30)	2736	(240,000)	180

This approach was among the factors considered in the development of *NBCC's* minimum fire-resistance rating requirements. Other critical factors included provisions for firefighting, exit capabilities, building size and interior fire protection.

The rule of thumb approach on which most model building codes are based today has been under review for the past 30 years. Closer consideration is now being given to factors, aside from fire load, which are known to affect fire severity such as:

- compartment ventilation
- thermal characteristics of compartment linings
- area of compartment boundaries
- compartment height.

The *NBCC* is currently preparing an objective based code for 2001. With the desired objective, or level of safety, specified, designers can use empirical and theoretical calculations to estimate the level of safety provided by a building system. These calculations take account of expected fire severity, heat transmission in building elements and the strength and deformation characteristics of structural members at elevated temperatures.

These more sophisticated calculations would probably involve some computer modelling (Section 5.4). It is currently the intention to have the new code also show prescriptive solutions that will be deemed to meet these objectives so that every building will not require modelling to determine the construction requirements. The current prescriptive requirements described in the 1995 *NBCC* will form the basis of these prescriptive alternatives.

As with other design procedures, the user must fully understand the underlying assumptions and limitations which affect these important factors if the values are to be truly representative of the design in question. Reference Numbers 5, 7, 8, 10, 11, 21, and 41 in the Appendix provide more detailed information on the various engineered design methods for fire safety.

FIRE-RESISTANCE RATING REQUIREMENTS FOR STRUCTURAL ASSEMBLIES

The difference between fire separation and fire-resistance rating is very important. A building component such as a column may require a fire-resistance rating but it is not a fire separation.

In this respect, the definition of fire-resistance rating might be misinterpreted as it refers to the passage of flame and the transmission of heat. Obviously, in the case of a column or beam, the applicable criteria is its ability to sustain the applied load for the specified time.

3.2.2.53. An assembly, such as a wall or a floor can also be required to be built as a fire separation but may not require a fire-resistance rating. For example, in office buildings three storeys or less in building height, the *NBCC* permits floor, mezzanine and roof assemblies to be:

- unrated noncombustible construction,
- combustible construction with a 45-minute fire-resistance rating, or
- heavy timber construction

However, floor assemblies in this case must be built as fire separations regardless of construction type. Therefore, a floor assembly of noncombustible construction would have to be constructed as a fire separation but would not have a required fire-resistance rating.

The rationale for when to specify the 45-minute fire-resistance rating for combustible construction and to waive this requirement for noncombustible assemblies was developed in the 1960s. This was based on the concept that structural stability under fire conditions and combustibility characteristics of the structure equate the two types of construction from a fire safety standpoint.

In simple terms, it was suggested that wood-frame construction with a 45-minute fire-resistance rating can be expected during a fire to be:

- structurally stable (1 plus), but,
- perceived as representing fuel load capable of contributing to the fire severity (1 minus)

On the other hand, unrated noncombustible construction was considered to be:

- non-fuel contributing (1 plus), but,
- with exposed steel supports, expected to be unstable (1 minus)

Simply adding these pluses and minuses, the two types of construction were considered equal and consequently a number of Articles in Subsection 3.2.2. of the *NBCC* permit either type to be used in certain size buildings (Design Requirement Tables in Chapter 4).

Although this approach has been accepted for years, with no apparent negative impact on fire safety, the principle of equating the two different types of construction from a fire safety standpoint is questionable.

Unprotected noncombustible construction collapses early in the standard fire-resistance test, usually within 10 minutes. A combustible assembly with a 45-minute fire-resistance rating stays in place for the duration of the test. Any fuel contribution from the combustible assembly is minimal during the test and occurs typically at the end of the test period.



In a real fire, assembly stability is critical in ensuring occupants time to evacuate. The impact of any fuel contribution from the structure on the severity of a fire in a room is expected to be minimal and should occur after the occupants have left the building.

Today's trend to develop less prescriptive- and more performance-based building codes is expected to have an impact on this traditional approach of equating the two types of construction. As code objectives are determined, the question of whether unprotected noncombustible construction provides an equivalent level of safety as rated combustible construction will have to be addressed. The fact that most fire casualties are attributed to fire severity and smoke caused by burning contents and are not related to building construction type must be taken into consideration.

FLOOR ASSEMBLIES IN RESIDENTIAL OCCUPANCIES

In certain small buildings, major structural assemblies such as floors and roofs need not be protected nor rated; however, they are expected to possess an inherent degree of fire-resistance, adequate to ensure occupant safety where complete building evacuation requires only a few minutes.

3.2.2.47. This is the case in smaller residential buildings, such as row housing. Floors within each dwelling unit, including the floor assembly over a basement, need not be constructed as fire separations

and do not require a fire-resistance rating (Figure 5.17).

If this were not permitted, the floor assemblies would have to be fire separations which is impractical. As a fire separation, all penetrations through the floor assembly within the individual dwelling unit, including the stairways, would have to be protected.

In such Group C buildings, however, floor assemblies must be constructed so that the fire separations between dwelling units is maintained. For wood-frame construction, how the joists are run relative to the wall will affect the protection features needed to maintain the continuity of the vertical fire separation. (Figure 5.18).

In small residential buildings with multi-storey dwelling units stacked above one another, floors within the units need not be constructed as fire separations but must have a fire-resistance rating. This means continuity is not required but floors must be built to stay in place longer during a fire. With one dwelling unit above another, structural stability is more critical as it could take longer for upper unit occupants to become aware of a fire below and evacuate the building.

Occupants both within the unit and in the adjacent units face increased risk when unit floors are not constructed as fire separations with a fire-resistance rating.

These risks are:

- the potential for early collapse of assemblies within the units

- the spread of smoke and hot fire gases from floor to floor within the unit.

3.3.4.2. Because of these potential hazards, limitations are placed on buildings constructed with floor assemblies not designed as fire separations (Figure 5.17).

The vertical travel distance from the lower floor to the uppermost floor within the unit is limited to 6m.

The minimum fire-resistance rating required for the fire separations between the individual dwelling units and the remainder of the building is determined by the building height and the provision of sprinklers. If the building is unsprinklered or more than three storeys in height, the fire separations must have a one hour fire resistance rating.

A fire-resistance rating of 45 minutes is required for the fire separations in sprinklered buildings less than 4 storeys in height.

FIRE-RESISTANCE RATING REQUIREMENTS OF LOADBEARING STRUCTURAL ELEMENTS

3.1.7.5. In most cases, loadbearing structural elements such as columns, walls and arches must have a fire-resistance rating at least equal to the rating required for the floor, roof or mezzanine assembly being supported. This requirement maintains the structural stability of the fire compartments formed within a building.

This is logical; to have a two-hour rated floor supported by unprotected steel columns that might collapse as soon as 10 minutes after flashover in the compartment below would make little sense.

FIGURE 5.17

Fire separations in residential occupancies

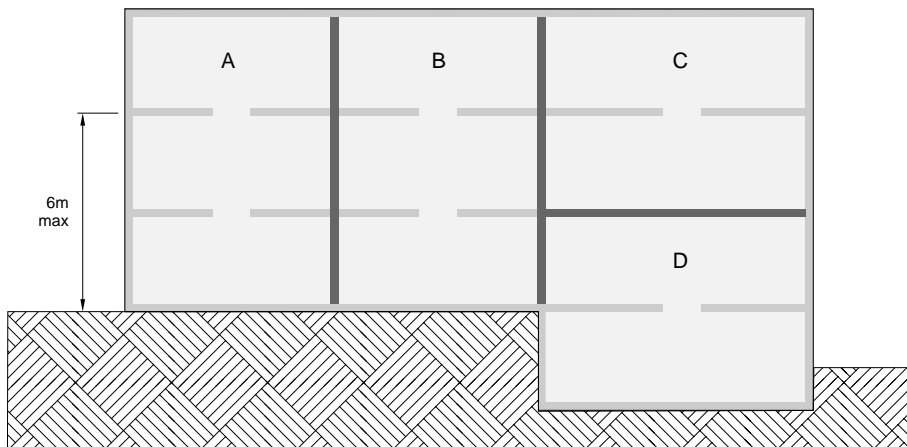

- Notes:
1. All units need to be separated from each other by fire separations having a fire-resistance rating of 1 hour.
 2. Floor assemblies in Units A and B need not be fire separations or have a fire-resistance rating.
 3. Floor assemblies within Units C and D need not be fire separations but must have a fire-resistance rating of at least 45 minutes.



FIGURE 5.18
**Continuity of
fire separations**

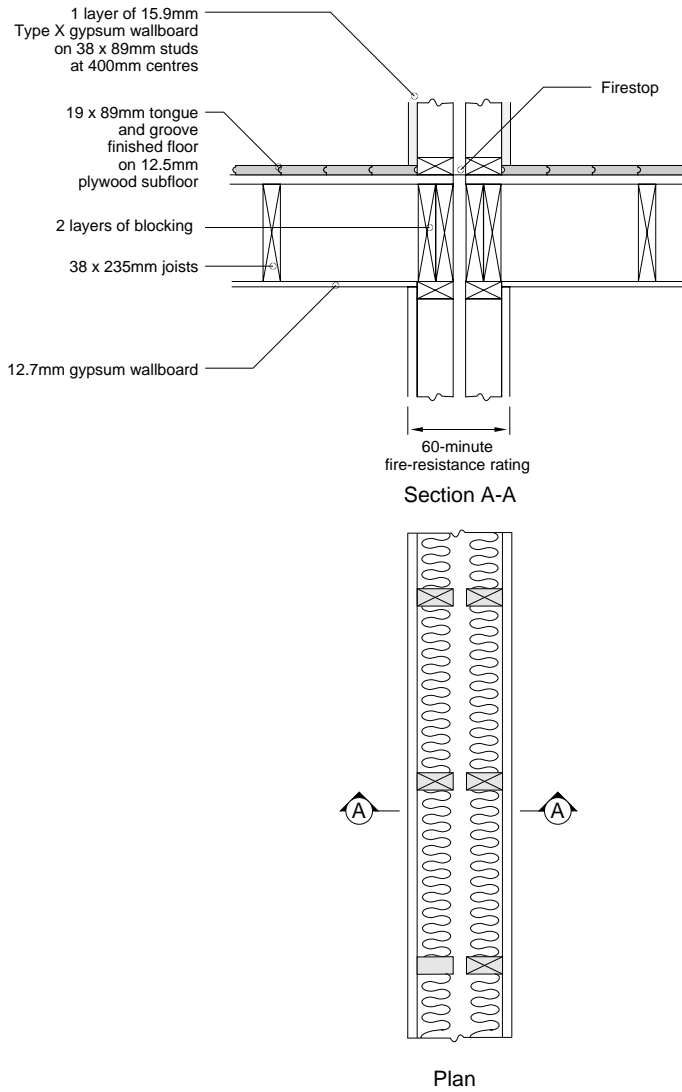

Note: The two layers of blocking are required when joists are parallel or perpendicular to the wall.

An exception to this general requirement permits the use of mixed types of construction, with unrated noncombustible construction and 45 minute rated combustible construction for some buildings (Figure 5.19) which are typically limited in size. Articles 3.2.2.21. to 3.2.2.81. specify where these mixed types of construction are permitted and when the loadbearing elements do not need a fire-resistance rating.

In these instances of mixed construction, a wood roof assembly would require a 45-minute fire-resistance rating or heavy timber construction. If the roof is built of unprotected steel, no rating is required. A wood-frame wall system supporting any of the three types of roof would have to have

a fire-resistance rating of 45 minutes but an unrated steel column could also be used. A heavy timber column and beam arrangement supporting any of the roofs would have to conform to the NBCC minimum sizes.

These provisions permit the use of unrated noncombustible supports to support a rated wood-frame assembly. These are partly based on the plus and minus point scoring system (discussed in the previous section) equating all three construction types from a fire safety standpoint. The apparent inconsistency of supporting rated construction with unrated supports is being questioned today. These anomalies will be examined with the move toward performance-based requirements in building codes.

FIGURE 5.19

Mixed construction: wood trusses on heavy timbers on steel columns



3.1.7.4. If a designer selects a building assembly with a fire-resistance rating exceeding *NBCC* minimum requirements, there is no obligation to provide an equivalent level of fire protection for the remainder of the building. The *NBCC* states that the supporting construction must have a fire-resistance rating not less than the minimum fire-resistance rating required.

If a 45-minute rating is required and the designer selects a one-hour rated floor assembly, the supporting construction for the assembly is only required to have a 45-minute rating. If mixed types of construction, unrated noncombustible or rated combustible, are permitted, the supports for this one-hour assembly would also be permitted to be heavy timber, or unprotected noncombustible construction.

Other exceptions to fire-resistance rating requirements of supporting construction deal with a vault concept. Extra fire-resistance may be necessary to contain either a high-hazard occupancy within a portion of a building or to protect valuable records from exposure to fire in the surrounding floor area. In such cases, it is not considered necessary to upgrade the fire-resistance rating of the building's structural frame supporting these additionally protected assemblies.

EXCEPTIONS TO FIRE-RESISTANCE RATING REQUIREMENTS

3.2.2.3.(1) Fire protection is not required for:

- steel components such as lintels, exterior support members for balconies and shelf angles
- steel members in protected exit stairways
- steel framework around shaft doorways and for the support of elevator guides (provided their collapse would not affect the building structure)

3.2.2.3.(1)(g) Steel members and structural concrete members for exterior use on certain buildings do not require fire protection if they meet the following criteria:

- buildings must be four storeys or less in building height
- occupancy must not be Group E or Group F, Division 1 and 2
- must be located at least 3m from the property line **(3.2.3.8.)**
- unprotected members have to be at least 1m away from unprotected openings in the exterior wall
- where the distance between the exterior unprotected member and the wall is less than 1m, adequate shielding must be provided from a fire inside the building

This applies primarily to exterior columns but could include exterior beams and other members. These exceptions allow design and architectural flexibility. The concept is a result of US and British research. The exception is not permitted for Group E and Group F, Division 1 and 2 occupancies as the fire load normally contained in these buildings is relatively high and more severe fires can be expected.

These unprotected members must be placed outside exterior walls although part of the member may be enclosed by the wall. They must be located at least 3m from the property line to guard against exposure from fire on adjoining properties.

Unprotected members have to be at least 1m away from unprotected openings in the exterior wall. This is required so that a fire in the building will not unduly expose the member to high radiation levels.

Where the distance between the exterior unprotected member and the wall is less than 1m, the NBCC requires adequate shielding from fire inside the building. This shielding is usually provided by the exterior wall adjacent to the member. The wall must have a fire-resistance rating at least equal to that required for the member had it been designed for use within the building.

The purpose of this shielding is to provide protection from radiant heat from a fire within the building. To provide this protection, the wall (or other shielding) must extend on either side of the member for a distance at least equal to the distance between the outside face of the wall and the outside face of the member (Figure 5.20). The exterior shielding wall should be constructed as if it were a fire separation without openings for the required distance.

FIGURE 5.20

**Exceptions
for exterior
unprotected
members**

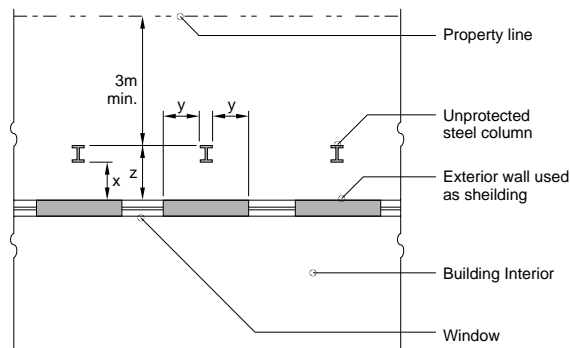

Notes:

1. If distance "x" is 1 m or more no column protection is required, except for conditions in note 3.
2. If distance "x" is less than 1 m, distance "y" must be equal to or greater than distance "z" and shielding must have a fire-resistance rating equal to that required for interior columns (or the exterior column be equally protected)
3. If the building is Group E (Mercantile) or Group F, Divisions 1 or 2 (Industrial), shielding or rating of the element is required regardless of the distance "x".

5.6

Fire Protection Requirements for Mezzanines and Atriums

3.2.8.1.(1) The *NBCC* generally requires that floor area sections which do not terminate at an outside wall, a firewall or a vertical shaft, terminate at a vertical fire separation with the same fire-resistance rating as the floor assembly. In circumstances where this is impractical, such as theatre balconies or mezzanines in a curling rink or other arena type buildings where an unobstructed view of the floor below is necessary, the *NBCC* waives the fire separation requirements.

3.2.8.2.(1) Mezzanines which are not considered as storeys in determining building height (Chapter 4) are also exempt. However, modern buildings often include large interior spaces, usually at entrance level, that are more than one storey and thus connect the overlooking floors or mezzanines. These atriums, the *NBCC* more broadly terms "inter-connected floor spaces", include floors connected by escalators, moving walkways or architectural stairways where the opening in the floor above is not enclosed.

Interconnected floor spaces warrant specific requirements because they violate the basic principle of compartmentation. These interconnected floor spaces present the following risks:

- fire could progress rapidly between levels of the structure, which lacks barriers to prevent smoke simultaneously contaminating all open levels of the building
 - occupants may be prevented from evacuating the building before being overcome by heat or smoke, since all levels have to exit at once
 - major structural components could be exposed to a prolonged fire condition, since no barriers exist to resist fire spread
 - fire-fighters who traditionally use the floor beneath a fire floor as a staging area could be impeded
- 3.2.8.** In the majority of cases, a building containing an inter-connected floor space must meet the following requirements:
- construction must be of noncombustible or heavy timber construction **3.2.8.3.**
 - the building must be sprinklered **3.2.8.4.**
 - vestibules must be provided for exits and for elevators opening into the space **3.2.8.5.**
 - occupants must be protected by cumulative exits, where all occupants on all floors can enter the stairs simultaneously, **3.4.3.3.(2)**, or
 - 0.3m² of treads and landings per person must be provided in the exit stairs, which gives a holding area that all occupants can enter but where they must wait to move to the outside, or
 - instead of this holding area, a protected floor space of 0.5m² per person must be provided **3.4.3.3.**



3.2.8.6. The protected floor space must be separated from the interconnected floor space by fire-rated construction. Occupants can leave the interconnected floor space and use the protected floor space as a waiting area before evacuation by stairs serving this space (Figure 5.21). Occupants must not have to re-enter the interconnected floor space in order to exit the building.

3.2.8.7. Most buildings containing an interconnected floor space require sprinklers to be installed throughout all portions of the building. Close-spaced sprinklers and draft stops must be provided around all but the largest of openings, just as for escalators. The draft stops provide a reservoir for products of combustion below the ceiling level intended to prevent smoke from spilling directly

into the open space; the heat build-up also ensures faster activation of sprinklers. Draft stops must be provided in larger interconnected floor spaces even when the close-spaced sprinklers are not required by Standard NFPA 13, *Installation of Sprinkler Systems*.

3.2.4.11.(1)(f) As well, smoke detectors must be located in the vicinity of the openings close to the draft stops.

3.2.4.7. & 3.2.4.9. In the 1995 NBCC, all sprinkler systems in buildings must be fully supervised and be arranged to transmit a signal to the fire department.

3.2.8.8. A mechanical exhaust system must be provided to clear smoke from the open interconnected floor space. This is a

FIGURE 5.21

Typical atriums and exits

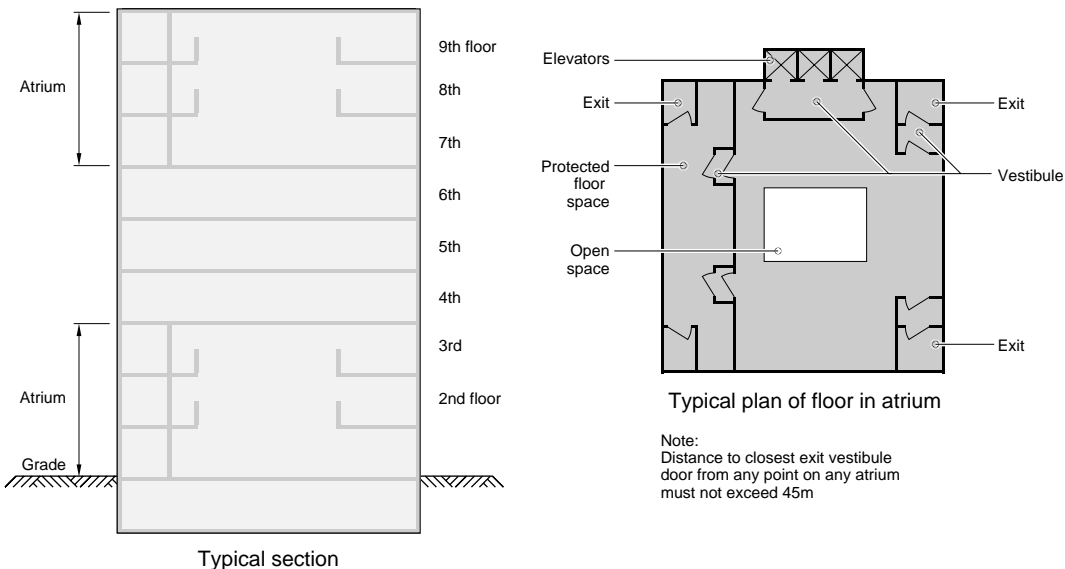

manual system, not an automatic smoke control system as required for high-rise buildings (Chapter 10).

3.2.8.9. Sprinklers situated high above the floor of an interconnected floor space may not respond quickly enough to a fire. For this reason, the quantity of combustible materials, (except for interior finishes), permitted in those parts of the interconnected floor space where the ceiling is more than 8m above the floor, is limited to 16 grams per cubic metre of volume of the interconnected floor space.

3.2.8.2.(5) For buildings containing smaller interconnected floor spaces, the requirements stated above are not required provided:

- the opening is used for escalators or inclined moving walks
 - each opening does not exceed 10m²
 - the building is sprinklered
- the interconnected floor space contains only Group A, Division 1, 2 or 3, Group D or Group E occupancies

3.2.8.2.(6) Buildings containing larger interconnected floor spaces do not have to meet the construction and fire safety requirements stated previously if the following conditions are met:

- the interconnected floor space consists only of the first storey and the storey above or below it
- the openings are used for stairways, escalators or moving walks or the interconnected floor space is sprinklered
- the interconnected floor space contains only Group A, Division 1, 2, or 3, Group D, E or Group F, Division 3 major occupancies
- the building area is not more than half the building area permitted in *NBCC* Subsection 3.2.2

5.7 Fire Stops

3.1.11.1. Normal framing methods in construction leave voids between members and membranes on each side of a wall. If these voids run the height of the building or connect with those in a ceiling space, hot gases and flames can spread far from the area of fire origin by air movement within these spaces. The *NBCC* therefore requires blocks of solid construction at regular intervals in all concealed spaces. Fire stopping is a good practice in both combustible and noncombustible construction.

3.1.11.7. Fire stopping restricts the passage of flames, hot gases and smoke. Fire stops can be made of:

- 38mm lumber or two layers of 19mm lumber
- plywood, waferboard or oriented strandboard (OSB) not less than 12.5mm thick for deeper spaces such as attics
- 12.7mm gypsum wallboard
- 0.38mm sheet steel
- any material which remains in place and restricts the passage of flames when subjected to the standard fire exposure of CAN/ULC-S101-M

The *NBCC* specifies type, thickness and location of fire-stop materials. The requirements give maximum dimensions, horizontally and verti-

cally, depending on the concealed space and on the surface flame-spread rating of the materials within the space. Figures 5.22 to 5.26 illustrate typical fire stopping.

3.1.11.5. Restrictions on the size of fire stopped compartments are eased when exposed materials within have a flame-spread rating of not more than 25. The materials within the space will not contribute significantly to fire intensity.

For example, in roof spaces or attics of combustible construction, fire stopping is required to separate the concealed space into compartments not more than:

- 300m² in area with no dimension more than 20m if the exposed construction materials have a flame spread rating more than 25
- 600m² in area with no dimension more than 60m if exposed construction materials have a flame spread rating not more than 25

There are no restrictions on compartment size if it is protected by automatic sprinklers.



FIGURE 5.22

**Wood-frame
fire stopping**

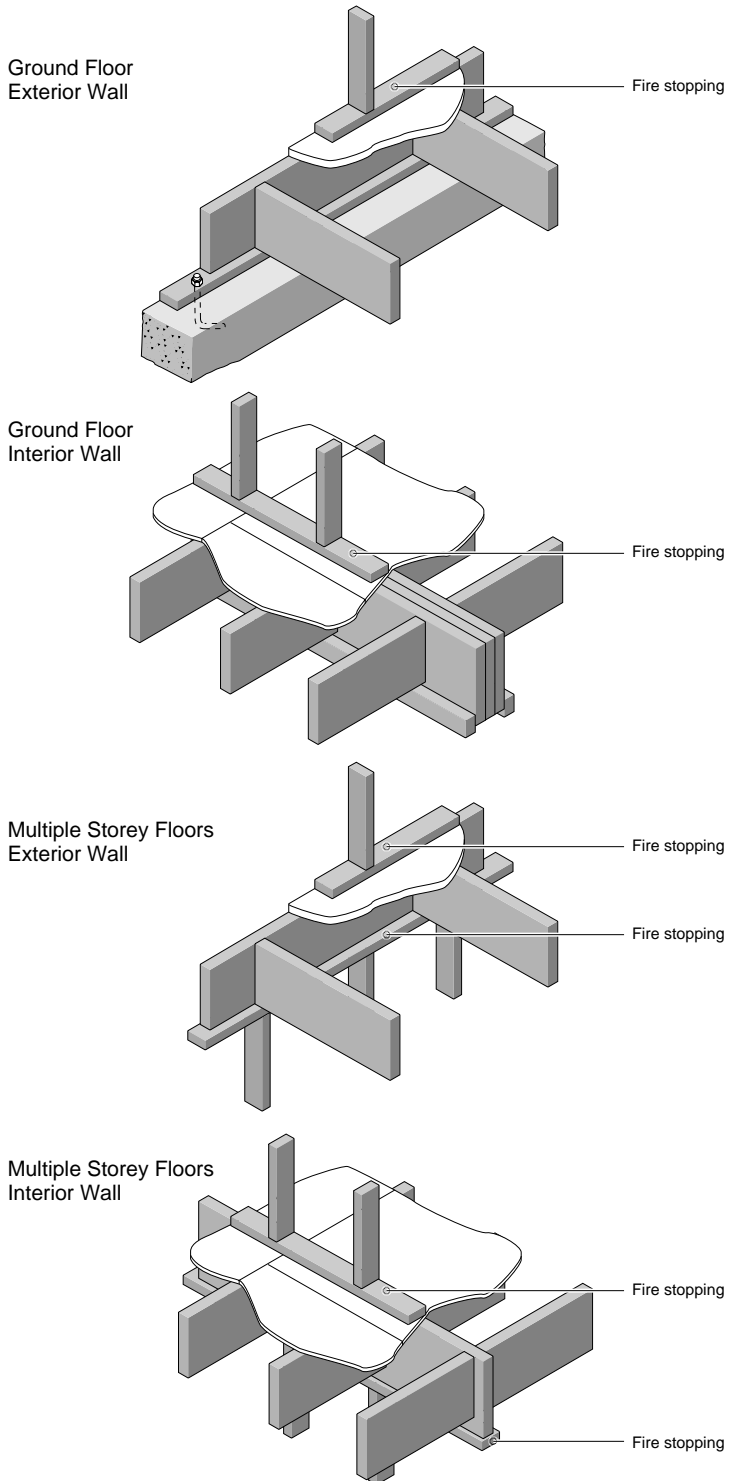

FIGURE 5.23

**Wood-frame
fire stopping**

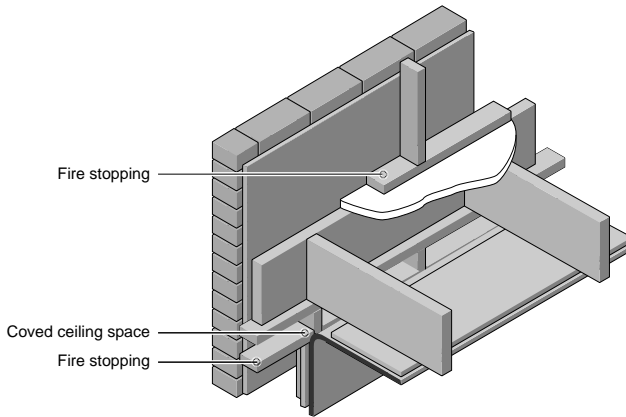

FIGURE 5.24

**Furring as fire
stopping**

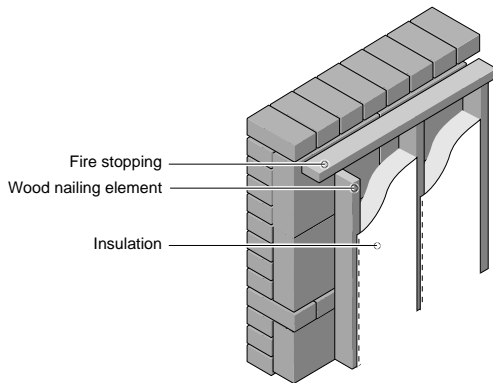

FIGURE 5.25

**Stair fire
stopping**

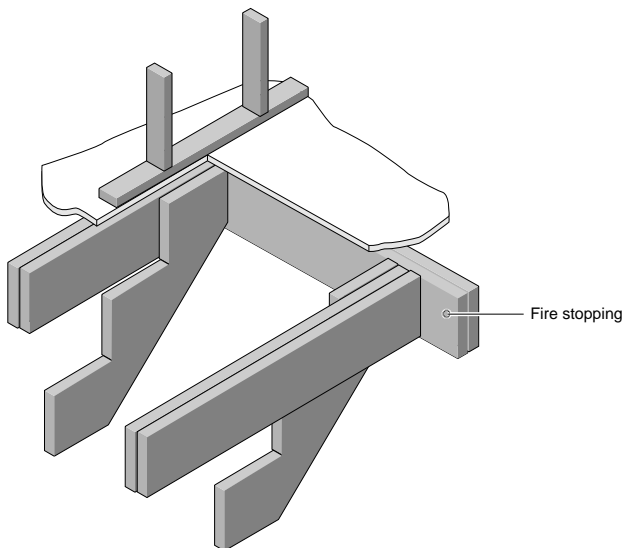

FIGURE 5.26

***Plywood as
attic fire
stopping***



3.2.3.15. The foregoing limits will often permit an attic or roof space to extend across more than two residential suites or more than two patient sleeping rooms in occupancies such as nursing homes. In such cases, fire stopping must isolate the attic or roof space from eave projections or roof overhang. The firestops are necessary to prevent flames projecting from an opening (window or door) in the exterior wall below the soffit from entering the roof space through vent openings in the soffit.

This additional fire stopping is not required when:

- the soffit is protected over the full width of the opening and over a distance extending 1.2m from the sides of the opening by noncombustible material, plywood, waferboard, oriented strandboard (OSB) or lumber with a minimum thickness depending on the material used (Chapter 7)
- the fire compartments behind the window or door openings are sprinklered.

5.8 Sprinkler Alternatives

The provision of automatic sprinklers in a building or floor area will in many instances relax the *NBCC* fire-protection requirements. The underlying principle is that a sprinkler system provides a level of fire safety at least equal to that of an unsprinklered building with passive fire protection requirements in place.

The *NBCC* Standing Committees on Fire Protection and Occupancy examined the benefits of sprinklers and also what fire safety requirements could be changed to produce an equivalent level of safety when the building is sprinklered. This review resulted in the requirement of mandatory

sprinklers in many more occupancies (Table 4.3). The review also resulted in an increase in the size of buildings permitted to be constructed of wood if they are sprinklered. The spatial separation requirements for sprinklered buildings have also been reduced. In light of these new provisions, all sprinkler systems must be electrically supervised and their activation must transmit a signal to the fire department.

Sprinkler installation costs can be weighed against savings resulting from their use, either in the form of reduced construction costs or reduced insurance premiums for the building. An automatic sprinkler system properly

FIGURE 5.27

Sprinklers allow use of heavy timber roof assemblies in large non-combustible buildings



installed and maintained ensures a high level of fire safety for occupants at all times.

Automatic sprinklers have a direct impact on fire protection requirements in several areas:

- The area or height of a building can be increased without increasing the level of fire resistance or changing construction type to that otherwise required for the larger sized building (Chapter 4).
 - The maximum size of openings permitted in a fire separation can be doubled. **3.1.8.6.**
 - Combustible sprinkler piping is permitted if compartments on both sides of a fire separation are sprinklered. **3.1.9.4.**
 - Compartments between fire stops in sprinklered roof spaces can be enlarged or in some cases fire stops can be omitted. **3.1.11.5.**
 - A heavy timber roof assembly can be used in all sprinklered buildings up to two storeys in building height without a limit on building area (Figure 5.27) **3.2.2.16.**
- The fire-resistance rating for roof assemblies is waived for all sprinklered buildings. **3.1.4.6.** This last item expands opportunities for the use of exposed unrated wood-frame roof assemblies especially in non-residential applications (warehouses, schools, retail stores). In this case, if glulam or solid sawn timber elements or solid wood roof decks are used, the heavy timber minimum sizing requirements would not apply.

Minimum size specifications for heavy timber components would still apply when a heavy timber roof assembly is used in a sprinklered noncombustible building of two storeys or less. However, no fire-resistance rating would be required for the roof assembly.

3.1.7.5. By waiving the fire-resistance ratings for roofs, the roof's loadbearing support elements such as columns or walls are also exempt from ratings.



Chapter Summary

Compartmentation and structural integrity are two of the most important basic principles of fire safety on which the *NBCC* requirements are based. These principles satisfy both branches of Contain Fire by Construction in the NFPA Fire Safety Concepts Tree (Chapter 3).

The weakest parts in fire separations are the openings provided for people and building services. Special attention must be given to these openings if fire separations are to serve their purpose. Increased hazards created by interconnected floor spaces also merit additional *NBCC* specifications. Code requirements for buildings with interconnected floor spaces provide for a level of safety similar to that possible with floor-to-floor separations.

Sprinklers are a viable alternative fire protection measure. Many fire-resistance and fire separation requirements are relaxed when automatic sprinklers are used because they can keep a fire under control until the firefighters arrive. In general, *NBCC* requirements combine the need for passive (compartmentation) and active (sprinkler and fire alarm) fire protection systems in buildings to ensure that the structure and the occupants will be adequately protected from fire.



6



Flame Spread of Materials

6.1	General Information	199
6.2	Determining Flammability	201
	The "Tunnel" Fire-Test Method for Interior Finishes	201
	Flame-Spread Ratings of Foam Plastics and Other Anomalous Materials	203
	Alternative Determination	204
6.3	Interior Finishes	207
	General	207
	Paint and Wall Coverings	207
	Flooring	208
	Light Diffusers and Lenses	208
	Application of <i>NBCC</i> Requirements	209
6.4	Fire-Retardant Treated Wood	213
	General	213
	Flame-Spread Rating	213
	Exterior Use	214
	Fire-Retardant Coatings	214
6.5	Roof Assemblies	217
	General	217
	Fire-Retardant Treated Wood Roof Systems	218
	Roof Coverings	219
	Testing	220
	Chapter Summary	223



6.1 General Information

Chapters 4 and 5 concentrated on the Contain Fire by Construction branch of the Manage Fire objective of the NFPA Fire Safety Concepts Tree introduced in Chapter 3. The construction methods or systems which create barriers to the spread of fire throughout a building were examined.

Once a fire is started, however, the rate at which it grows has a significant impact on the safety of the occupants and the time available for their escape. This depends largely on the flammability of building contents and materials. This concept is expressed by the Control Fuel branch of the Manage Fire objective.

In an attempt to control the fuel present, the *NBCC* restricts the surface flammability of:

- all interior finishes in buildings

- materials contained within concealed spaces
- materials used in roof assemblies

This chapter explains the fire test procedure used for determining flame-spread ratings for building materials. Alternative flame-spread rating values for generic products are listed as are values for common wood species.

The principles underlying the minimum requirements of the *NBCC* are discussed. Many wood products can be used as finishes throughout buildings without fire-retardant treatments.

Fire-retardant treated wood, a special type of wood finish, is discussed along with the *NBCC* requirements for roof assemblies and roof coverings.

In Group A, Division 2 occupancies, walls and ceiling finishes with a Flame Spread Rating of up to 150 are permitted.



6.2 Determining Flammability

THE “TUNNEL” FIRE-TEST METHOD FOR INTERIOR FINISHES

As indicated in Chapter 3, flammability is the property of a material to burn more or less quickly.

The need to control the flammability of building content and their materials was highlighted by a number of major fires, mostly in the 1940s and 1950s, which resulted in extensive loss of life and property.

In the Cocoanut Grove fire in 1942, for example, it was estimated that the fabric of the ceiling decoration in the room where the fire originated had a flammability in excess of 16 times what is permitted today by the *NBCC*.

The rapid and uncontrolled spread of fire in many other instances such as the Winecoff Hotel, LaSalle Hotel and St. Anthony Hospital fires was clearly related to the rapidity of flame spread on the interior finish (Chapter 1). Asphyxiation was also the cause of many fatalities.

This prompted regulatory authorities to determine means of classifying materials in accordance with at least two essential fire properties:

- surface flame spread
- smoke developed

The fire-test method which has been used for the last 30 years to determine these properties was devised by A. Steiner at Underwriters' Laboratories Inc. in the United States.

FIGURE 6.1

The Steiner tunnel for measuring surface burning characteristics

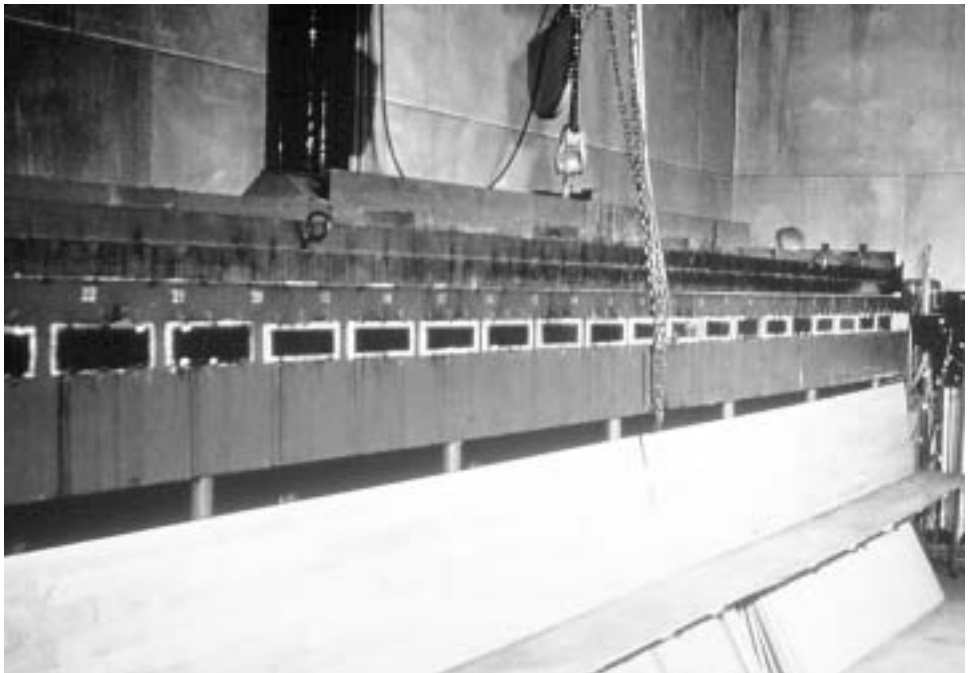

3.1.12.1. In Canada, it is described in the standard published by Underwriters' Laboratories of Canada, CAN/ULC-S102, *Standard Method of Test for Surface Burning Characteristics of Building Materials and Assemblies*.

The fire-test method provides a relative assessment of the surface burning characteristics of materials. The sustained flaming combustion which occurs at the surface of a material is measured. Flaming on most materials progresses along the surface as additional volatiles are released and mixed with the oxygen from the heated area immediately adjacent to the flaming area.

The test furnace is usually referred to as “the Steiner tunnel” or just “the tunnel” because of its shape; it consists of a rectangular duct 7.6m long, 450mm wide and 300mm deep (Figure 6.1).

The walls and floor of the tunnel are constructed of refractory brick, except for a row of glazed ports used for viewing. These windows extend the length of the chamber on one side. The tunnel has a noncombustible, full-length airtight lid which can be removed to position the test specimen sample along the top of the furnace.

For most materials, the test specimen is installed on the ceiling of the tunnel. At one end of the tunnel, gas burners produce a flame with a steady heat release that impinges directly on the test specimen. A steady draft of air lightly fans the flames toward the other end.

The test lasts 10 minutes for materials commonly used for interior finishes. The distance traveled by the flame front is observed through the viewing ports and recorded against time.

The test results provide a relative assessment of the flammability of materials. The flame spread measured on a specific product is evaluated against two products which serve to calibrate the apparatus:

- inorganic reinforced cement board assigned a flame-spread rating of 0
- red oak assigned a flame-spread rating of 100

When a noncombustible material such as inorganic reinforced cement board is tested, the flames from the burners, forced towards the other end of the tunnel by the flow of air, will extend approximately 1370mm, and will not progress beyond that point.

With select red oak flooring, the flame will continue to advance towards the end of the tunnel, 7.6m away, which it reaches in approximately 5.5 minutes.

At the vent end of the tunnel, a photo-electric device measures the opacity (density) of the smoke. This provides an indication of the amount of smoke released from the burning material. This is particularly important in the case of certain types of materials which can release substantial amounts of smoke without having a high degree of flammability.

All tested materials are compared to these two reference materials and the results of the tests provide what is termed the flame-spread rating (FSR) and the smoke developed classification (SDC).

3.1.12.1.(1) Because there is usually some degree of variation in test results, the *NBCC* requires that the flame-spread rating and smoke developed classification be determined from the average of at least three tests for each material.

Not all materials react in the same way under the test. For example, in testing gypsum wallboard, the flame front typically advances for the first two minutes and then recedes. In the case of loose-fill cellulose insulation, the flame front first advances, then recedes and advances again.

To account for these different reactions and to obtain a more uniform ranking of materials, the latest edition of the CAN/ULC-S102 uses formulae (developed by George Williams-Leir) to normalize test results. The formulae are given in Appendix 2 of the ULC standard.

FLAME SPREAD RATINGS OF FOAM PLASTICS AND OTHER ANOMALOUS MATERIALS

If a building material is intended to be used as a finished floor surface, testing on the ceiling of the tunnel will not be representative of end use conditions. In addition, the material might react quite differently with flames impinging on it in an upside down position.

Certain materials tend to drip and melt, or sag under their own weight when exposed to a fire source. Tests on the tunnel ceiling of these materials could result in some anomalies if the material melted or dropped down and away from the fire source.

3.1.12.1.(2) The *NBCC* requires such materials (when regulated) be tested in accordance with ULC standard CAN/ULC-S102.2, *Standard Method of Test for Surface Burning Characteristics of Flooring, Floor Covering, and Miscellaneous Materials and Assemblies*.

In this test, the samples are placed on the floor of the tunnel and the burner gas ports are turned downward. The same formulae used in normalizing test results for the CAN/ULC-S102 standard are used in that red oak is assigned a flame-spread rating of 100 and reinforced inorganic cement board a flame-spread rating of 0, when both are tested on the floor of the tunnel.

Some materials, primarily foamed plastics, show anomalous behavior in the tunnel. The flame front initially progresses rapidly, then slows down or recedes, in most cases not reaching the end of the tunnel.

A separate formula is used to assign a flame-spread rating for such materials. The formula is based solely on the rate of flame propagation along the surface of the material to the point where the flame front stops and begins to recede.



This formula was developed because the original formulae yielded low flame-spread ratings for foamed plastics, when actual fire situations suggest much higher values.

In some tests conducted on either the ceiling or the floor of the tunnel, certain materials exhibit rapid flaming across the surface. This makes it difficult to measure the actual rate of flame propagation. Another unusual case occurs when a char layer forms, inhibiting burning along the surface of the material after an initial flash of flaming.

When either case occurs, the corner-wall test, ULC standard CAN/ULC-S127, must be used to assign a flame-spread rating instead of either of the ULC S102 or S102.2 tunnel test methods mentioned earlier.

2.5.3.1. The *NBCC* allows the authority having jurisdiction to accept the results of tests conducted in accordance with other standards provided they are considered equivalent. It should be noted, however, that tests performed under earlier editions of the CAN/ULC S102 and S102.2 standards are not the same as current editions because the calculation methods have changed over the years to account for the properties of new materials.

This would also apply to the US tunnel standards, ASTM E84 and NFPA 255, which use similar apparatus but have minor operational differences.

In these two American standards, there are no provisions for testing products on the floor of the tunnel. As a result, thermoplastic materials (including some foamed plastics), which melt or drip when exposed to the fire obtain a lower flame-spread rating in the US than in Canada.

ALTERNATIVE DETERMINATION

D-3.1.1. The flame-spread rating and smoke developed classification of a material may also be determined from the information contained in Appendix D of the *NBCC*.

Information is only provided for generic materials for which extensive fire test data is available (Table 6.1). For instance, lumber, regardless of species, and Douglas fir, poplar, and spruce plywood, of a thickness not less than those listed, are assigned a flame-spread rating of 150.

In general, for wood products up to 25mm thick, flame-spread rating decreases with increasing thickness. Values given in the Appendix D of the *NBCC* are

TABLE 6.1

Assigned flame-spread ratings and smoke developed classifications

Materials	Applicable Standard	Minimum Thickness mm	Unfinished ³		Paint or Varnish not More than 1.3mm Thick, Cellulosic Wallpaper not more than 1 Layer ^{5,6}	
			FSR	SDC	FSR	SDC
Hardwood or softwood flooring ³	—	—	300	300		
Gypsum wallboard	CSA A82.27-M ⁴	9.5	25	50	25	50
Lumber	None	16	150	300	150	300
Douglas Fir plywood ¹	CSA O121	11	150	100	150	300
Poplar plywood ¹	CSA O153	11	150	100	150	300
Plywood with Spruce face veneer ¹	CSA O151	11	150	100	150	300
Douglas Fir Plywood ¹	CSA O121	6	150	100	150	100
Fiberboard low density	CSA A247	11	> 150	100	150	100
Hardboard Type 1 Standard	CGSB-11.3	9	150	> 300	²	²
		6	150	300	150	300
Particleboard	CAN3-O188.1	12.7	150	300	²	²
Waferboard	CAN3-O437	—	²	²	²	²

Notes:

1. The flame-spread ratings and smoke developed classifications shown are for those plywoods without a cellulose resin overlay.
2. Insufficient test information available.
3. Wood flooring unfinished or finished with a spar or urethane varnish coating.
4. Gypsum Wallboard complying with the following ASTM standards is also acceptable - ASTM C36, ASTM C442, ASTM C588, ASTM C630 & ASTM C931.
5. Flame-spread ratings and smoke developed classifications for paints and varnish are not applicable to shellac and lacquer.
6. Flame-spread ratings and smoke developed classifications for paints apply only to alkyd and latex paints.

Source: Appendix D, Section D-3, 1995 NBCC



conservative because they are intended to cover a wide range of materials. Specific species and thicknesses may have values much lower than those listed in Appendix D.

Specific ratings by species are given in Table 6.2. Information

on proprietary and fire-retardant materials is available from ULC listings or from manufacturers. The values listed in Table 6.2 apply to finished lumber, however, there has been no significant difference in flame-spread rating noted in rough sawn lumber.

TABLE 6.2

Typical flame-spread ratings and smoke developed classifications of wood products

Product		Flame-Spread Ratings	Smoke Developed Classification
Lumber, 19mm thickness			
Cedar	Western Red	73	98
	Pacific Coast Yellow	78	90
Fir	Amabilis (Pacific Silver)	69	58
Hemlock	Western	60-75	
Maple	(flooring)	104	
Oak	Red or White	100	100
Pine	Eastern White	85	122
	Lodgepole	93	210
	Ponderosa	105-230	
	Red	142	229
	Southern Yellow	130-195	
	Western White	75	
Poplar		170-185	
Spruce	White	65	
	Sitka	74	74
	Western	100	
Shakes	Western Red Cedar	69	
Shingles	Western Red Cedar	49	

6.3 Interior Finishes

GENERAL

3.1.13.1.(1) Any material that forms part of the building interior and is directly exposed is considered to be an interior finish. This includes interior claddings, flooring, carpeting, doors, trim, windows, and lighting elements.

If no cladding is installed on the interior side of an exterior wall of a building, then the interior surfaces of the wall assembly are considered to be the interior finish, for example, unfinished post and beam construction. Similarly, if no ceiling is installed beneath a floor or roof assembly, the unfinished exposed deck and structural members are considered to be the interior ceiling finish.

PAINT AND WALL COVERINGS

When a surface finish such as paint, wallpaper, wood veneer, fabric or plastic is applied to a substrate such as plaster, gypsum wallboard or plywood, it is then considered as the interior finish.

Normally, the surface finish and the material to which it is applied both contribute to the overall flame-spread performance. Most surface coatings such as paint and wallpaper are usually less than 1mm thick and will not contribute significantly to the overall rating.

This is why the *NBCC* assigns the same flame-spread and smoke developed rating to common materials such as plywood, lumber and

gypsum wallboard whether they are unfinished or covered with paint, varnish or cellulosic wallpaper (Table 6.1).

Paint and wallpaper of a conventional thickness usually provide additional protection for the underlying surface. Depending on their composition, they may even slightly reduce the flame-spread rating of the interior cladding.

There are also special fire-retardant paints and coatings that can substantially reduce the flame-spread rating of an interior surface. These coatings are particularly useful when rehabilitating an older building to reduce the flame-spread rating of finish materials to acceptable levels, especially for those areas requiring a flame-spread rating no greater than 25.

Other coatings, such as fabric wall covering, which are usually thicker than 1mm, can present a fire hazard of their own and must be tested in accordance with the reference standard together with the underlying material. This is because the substrate, including any adhesives used, can significantly affect test results.

Veneers, such as corkboard and fibreboard, and other finishes such as acoustic tiles or carpeting attached to interior wall cladding, are treated as surface coatings rather than cladding.

Care must be exercised to specify adhesives resistant to high temperatures so that finishes will not peel readily during a fire



and expose the underlying surface. Phenol-resorcinol, melamine or melamine-urea adhesives are often used. These proprietary materials must, of course, be tested in accordance with ULC standards.

3.1.4.2.(1) Foamed plastic materials are not permitted as an interior finish in occupied portions of a building. They must be protected by plywood, gypsum wallboard or other acceptable thermal barrier material even when their flame-spread rating is within acceptable limits.

This requirement for a thermal barrier is partly due to concerns for smoke generation. It also takes account of the fact that, with no thermal barrier over the insulation product, there can be a faster temperature build-up in a room during a fire. This can increase the potential for flashover.

FLOORING

In a room fire, the flooring is usually the last item to be ignited, since the coolest layer of air is near the floor.

3.1.13.7.(1) & (2) For this reason, the *NBCC*, like most other codes, does not regulate the flame-spread rating of flooring, with the exception of certain essential areas in high buildings:

- exits
- corridors not within suites
- elevator cars
- service spaces

However, with the new requirements for sprinklers in all high buildings in the 1995 *NBCC*, the stricter limits placed on interior finishes, including floors, no longer apply except in Group B major occupancies.

Traditional flooring materials such as hardwood flooring and carpets can, therefore, be used almost everywhere in buildings of any type of construction.

It should be noted that carpets glued or nailed to an unfinished floor are considered part of the interior finish, while loose rugs are considered part of the building contents. Similarly, wood based panels used as a wearing floor over a metal or concrete deck should not be considered part of the structure or the interior floor finish unless permanently attached to the deck.

3.1.5.8.(4) Where permanently attached, these wood panels would be considered the finished floor, which is permitted to be combustible in noncombustible buildings in any case.

LIGHT DIFFUSERS AND LENSES

The *NBCC* also regulates light diffusers and lenses, which are the panels that form the light emitting portion of lighting fixtures. Modern fixtures are usually made from translucent or transparent synthetic materials, many of which do not meet the basic flame-spread requirements for interior ceiling finish.

3.1.13.4. Except for Group A, Division 1 occupancies, the *NBCC* allows the use of light diffusers and lenses that exceed the flame-spread rating limits required for a particular location provided that, when tested in the tunnel in conformance with ULC Standard CAN/ULC-S102.3, *Standard Method of Fire Tests of Light Diffusers and Lenses*, they fall to the bottom of the test apparatus before being ignited.

This drop-down feature is required to avoid having a continuous surface which could spread flames across a ceiling in a real fire situation.

In addition, when these light diffusers and lenses are tested in accordance with CAN/ULC-S102.2, they cannot have a flame-spread rating exceeding 250 nor a smoke developed classification over 600. These lighting elements must be installed so that nothing below will prevent them from falling out of the ceiling.

For increased fire safety, additional requirements apply to fire separated corridors and exits to ensure that the lighting elements are sufficiently spaced from each other thereby reducing the flame-spread potential.

APPLICATION OF NBCC REQUIREMENTS

The level of *NBCC* requirements for flame-spread ratings is relative to the importance of a space as a means of escape. The more essential the space is as a link

to safety for a greater number of occupants in the building, the more restrictive the requirements.

From a room or suite, occupants would normally escape to a space common to many other rooms, such as a corridor, and proceed to a space, such as an exit stairway, toward which other floors would also converge.

Obviously, maximum protection will be required in the exit stairway, since a fire in the exit would jeopardize all occupants of the building. A fire in a corridor would hamper the evacuation of occupants on one floor alone. Even less stringent requirements would apply in a room.

It should be noted that flame-spread requirements apply equally to combustible and noncombustible construction because they concern the rate of fire spread along interior finishes, and not the structural fire resistance of the structure.

3.1.5.10. & 3.1.13.8. One peculiarity concerning noncombustible construction should also be considered: the flame-spread rating of the material must apply not only to the exposed surface but also to any surface that would be exposed by cutting through the material in any direction.

Lumber and heavy timber meet this requirement since they are homogeneous; grain orientation does not affect flame spread.



3.1.5.10.(3) & 3.1.13.8.(1) Fire-retardant treated wood is exempt from the requirement, recognizing that the fire-retardant chemicals, while reducing the surface flame spread rating, do not penetrate the entire wood member. This exception does not apply to fire retardant paints or coatings which are surface applied.

Composite wood products call for individual consideration. Oriented strandboard (OSB) and waferboard are relatively homogeneous. Products with definite glue planes such as plywood and glue-laminated timber delaminate as they burn in the tunnel test, so the effects of the glue are already reflected in the flame-spread rating. In practice, the rule is meant to be applied to products which may, realistically, be used with the surface lamination removed.

3.1.13.2.(1) In general, the *NBCC* sets the maximum flame-spread rating for interior wall and ceiling finishes at 150, which can be met by most wood products.

D-3.1.1. For example, 6mm Douglas Fir plywood may be unfinished, painted, varnished or covered with conventional cellulose wallpaper. This has been found to be acceptable on the basis of actual fire experience.

This means that in all areas where a flame-spread rating of 150 is permitted, the majority of wood products may be used as

interior finishes without special requirements for fire-retardant treatments or coatings.

3.1.13.2.(2) Doors are permitted to have a flame-spread rating of 200 with exceptions commensurate to the occupancy hazard (more restrictive for Group A, Division 1 assembly occupancies, no restrictions on doors within dwelling units).

3.1.13.6.(1) In areas such as public corridors and corridors in care and detention occupancies, the maximum flame-spread rating is set at 75, but the *NBCC* will also allow the lower half of walls in the corridor to have a maximum flame-spread rating of 150 if the top half has a flame-spread rating of not more than 25.

3.1.13.2.(4) Similarly, in all areas where a flame-spread rating of less than 150 is required, up to 10% of the wall and ceiling area can have a rating of at most 150. This would apply to exits, where a maximum flame-spread rating of 25 is required, and is generally permitted to account for combustible trim, handrails and lighting fixtures.

The application of the requirements for interior finishes in those areas where the *NBCC* imposes stricter limits is otherwise covered in Tables 3.1.13.2. and 3.1.13.7. Tables 6.3 and 6.4 summarize the *NBCC* requirements by location and element.

TABLE 6.3

NBCC requirements for interior finish⁵ and exterior glazing

Description of Regulated Area	NBCC Reference	Interior Finish Requirements ^{2,3}
Buildings of noncombustible construction	3.1.5.4. and 3.1.5.10.	<p>Walls: 150 FSR</p> <ul style="list-style-type: none"> • not more than 25mm in thickness • FSR must be homogeneous throughout the material <p>Ceilings: 25 FSR</p> <ul style="list-style-type: none"> • not more than 25mm in thickness except for fire-retardant treated wood battens • FSR must be homogeneous throughout the material except for fire-retardant treated wood • 10% of ceiling area within a fire compartment may have up to 150 FSR <p>Combustible vertical glazing:</p> <ul style="list-style-type: none"> • 75 FSR permitted up to the second storey • 150 FSR permitted on the first storey provided glazing does not exceed 25 percent of the wall area ⁴
Group A, Division 1 occupancies including doors, skylights, glazing and light diffusers and lenses	3.1.13.2.	75 FSR ^{1,6}
Group B occupancies	3.1.13.2.	75 FSR ^{1,6}
Public corridors, corridors used by the public in Group A and B occupancies and corridors serving classrooms and patients' sleeping rooms	3.1.13.2.(4) and 3.1.13.6.	Walls: not more than 75 FSR ¹ or upper half of 25 FSR ¹ and lower half of 150 FSR ⁶ Ceiling: not more than 25 FSR ^{1,6}
Other Occupancies	3.1.13.2.	150 FSR
Doors in all occupancies except Group A, Division 1	3.1.13.2.(2)	200 FSR
Doors within dwelling units	3.1.13.2.(3)	FSR not regulated
Bathrooms within suites of residential occupancy	3.1.13.3.	200 FSR
All buildings except Group A	3.1.13.4.(1)	Ceiling light diffusers and lenses not more than 250 FSR and 600 SDC with drop out requirement and size and separation restrictions
Exits including exterior exit passageways described in Article 3.1.13.10. providing the only means of egress	3.1.13.2. and 3.1.13.8.(1)	25 FSR ¹ . In noncombustible buildings the FSR must be homogeneous throughout the material except for doors, fire-retardant treated wood and heavy timber construction in sprinklered buildings.
Lobby used for exiting as described in Sentence 3.4.4.2.(2)	3.1.13.2.(1) and 3.1.13.2.(4)	25 FSR ¹ except that up to 25% of the total wall area not including combustible doors is permitted to have 150 FSR
Underground walkways	3.1.13.9.	Except for paint, only noncombustible materials permitted
Covered vehicular passageways except for heavy timber roof assemblies	3.1.13.2.(1)	25 FSR ¹
Vertical service spaces	3.1.13.2.(1)	25 FSR ¹

Notes:

- Up to 10% of the total wall area and 10% of the total ceiling area is permitted to have a 150 FSR. Except in Group A, Division 1 occupancies, doors, skylights, glazing and light diffusers and lenses need not be considered in the calculation. **3.1.13.2.(4) & (5)**
- FSR is the flame-spread rating and SDC is the smoke developed classification.
- Exposed foam plastics are not permitted on walls or ceilings. **3.1.4.2. & 3.1.5.11.**
- In a sprinklered building, glazing is also permitted on second storey.
- Unless otherwise specified, FSR's apply to both walls and ceilings.
- For sprinklered buildings, the FSR is permitted to be 150.



TABLE 6.4

Additional interior finish requirements for high buildings regulated by Subsection 3.2.6.

Description of Regulated Area	Interior Finish Requirements ² Unsprinklered buildings	Sprinklered buildings ¹
Exit stairways, vestibules to exit stairs, and exit lobbies described in Sentence 3.4.4.2.(2)	Walls, ceilings and floors not more than 25 FSR and not more than 50 SDC ^{3,4}	see Table 6.3
Corridors not within suites	Walls not more than 100 SDC, ceilings not more than 50 SDC. See Table 6.3 for FSR limits ^{3,4} Floors not more than 300 FSR and not more than 500 SDC.	see Table 6.3
Elevator cars and vestibules	Walls and ceilings not more than 25 FSR and not more than 100 SDC. Floors not more than 300 FSR and not more than 300 SDC.	
Service spaces and service rooms	Walls, ceilings and floors not more than 25 FSR and not more than 50 SDC	see Table 6.3
Lighting elements	see Table 6.3	see Table 6.3
Other locations and elements	Walls not more than 300 SDC, ceilings not more than 50 SDC. See Table 6.3 for FSR limits.	see Table 6.3

Notes:

1. Buildings of Group B major occupancy and elevator cars are not included.
2. FSR is the flame-spread rating and SDC is the smoke developed classification.
3. Does not apply to 10% of wall or ceiling finish including trim and millwork which may have 150 FSR and 300 SDC.
4. Does not apply to 10% of wall finish which may be doors which have 200 FSR and 300 SDC.

6.4 Fire-Retardant Treated Wood

GENERAL

Fire-Retardant Treated Wood (FRTW) is wood which has been impregnated with fire-retardant chemicals in solution under high pressure in accordance with CSA standard O80, *Wood Preservation* (Figure 6.3). The treatment reduces surface burning characteristics, such as flame spread, rate of fuel contribution and smoke contribution.

To dispel any myths that may still exist, the treatment does not make the wood noncombustible. This idea stems from certain earlier codes which equated a 25 flame-spread rating to noncombustibility.

FRTW contains different chemicals than products known as preservative treated wood. However, the same manufacturing process is used

to apply the chemicals. The products are not interchangeable. FRTW products burn at a slower rate than untreated wood products.

FLAME-SPREAD RATING

3.1.4.4. When FRTW is specified in the *NBCC*, it must have a flame-spread rating of not more than 25 when tested in conformance with CAN/ULC-S102.

It therefore qualifies as an interior finish for any application since the most restrictive flame-spread rating is 25.

FRTW must be identified by a label from an independent testing laboratory which indicates that the necessary tests were made and production controls maintained (Figure 6.2).

FIGURE 6.2

FRTW label

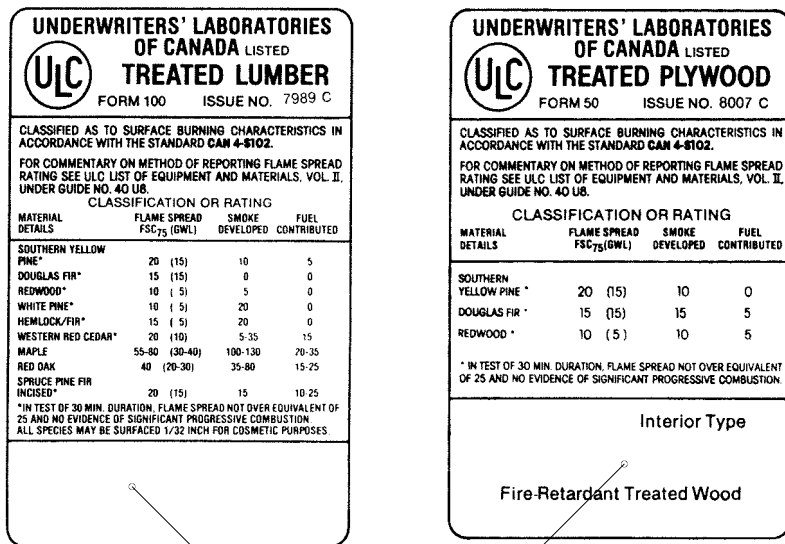

Manufacturer's name, address, and product name



For many wood species, and particularly plywood and lumber in sizes common to frame construction, treatment results in chemical retentions high enough to obtain a flame-spread rating of 25 or less. It should be noted that the chemicals will not usually penetrate the entire wood member; refusal will usually occur when the chemicals have penetrated approximately 13mm from the outer surface.

3.1.13.8. The *NBCC* recognizes this special characteristic. FRTW is exempt from the requirement that a material exhibit its assigned flame-spread rating, whatever it may be, on any surface that would be exposed by cutting through the material in any direction, if to be used for interior finish in noncombustible buildings.

The actual flame-spread rating of treated lumber or plywood depends on the fire-retardant chemicals used and the amount of chemicals retained in the wood.

Commonly used chemicals are proprietary mixtures which are free of halogens, sulphates, ammonium phosphate and formaldehyde. These provide superior performance characteristics over previous formulations and lower corrosivity to metal fasteners. These water-soluble chemicals are effective in reducing flame spread, and through careful proportioning succeed in reducing smoke development and afterglow.

EXTERIOR USE

When FRTW products are used in areas where the material is

exposed to weather or high humidity, it must be treated with special non-leaching chemicals similar to those used for fire-retardant treated cedar shakes and shingles.

An accelerated weathering test (ASTM D2898) exposes FRTW to regular wetting and drying cycles to represent actual long-term outdoor conditions. FRTW must still achieve a flame-spread rating of 25 after undergoing this accelerated weathering in order to qualify for exterior use.

3.1.5.5.(4) & (5) These requirements apply to exterior grade fire-retardant treated plywood siding over wood studs in exterior walls of noncombustible buildings and FRTW decorative cladding on exterior marquee fascias of noncombustible buildings. (Chapters 2 and 4).

FIRE-RETARDANT COATINGS

Listed fire-retardant coatings applied to wood also reduce the flame-spread rating to less than 75 or 25. These coated products can be used for interior finish in noncombustible buildings except where the flame-spread rating limits apply not only to exposed surfaces but also to surfaces that may be exposed by cutting through the product in any direction.

FRTW products are excluded from these requirements while products protected by fire-retardant coatings are not. This recognizes the permanency of the fire-retardant treatments.

FIGURE 6.3

*Loading wood
into fire-
retardant
treatment
pressure
cylinder*



6.5 Roof Assemblies

GENERAL

All components of a roof assembly influence its performance under fire conditions.

In the past, roof assemblies were assumed to be safe under fire exposure if the deck and its supports were constructed of noncombustible material even though the vapor barrier, adhesives and roof covering were combustible.

In 1953, one of the largest single fire losses recorded (\$45 000 000) proved the fallacy of this assumption. At the General Motors plant in Livonia, Michigan, highly combustible vapors from asphalt roofing products leaked through the noncombustible deck, rapidly spreading fire along the underside of 14 hectares of roof. This caused the collapse of the unprotected structural steel assembly

and rendered fire-fighting operations ineffective.

The Livonia loss prompted the development of improved adhesives and vapor barriers to reduce the production of vapors that could penetrate metallic roof decking and contribute to the spread of fire.

At the same time, an extensive research and testing program was undertaken on large-scale specimens (30.5m x 6m) to develop criteria for the performance of roof assemblies. Large-scale tests are prohibitively expensive and further research was commissioned to devise a test using the Steiner flame-spread tunnel.

The result of this effort is incorporated in ULC standard CAN/ULC-S126, *Standard Method of Test for Fire Spread under Roof-Deck Assemblies*. It requires the flame spread on the

FIGURE 6.4

FRTW roof assembly alternative



FIGURE 6.5
*Fire-retardant
treated wood
roof systems*

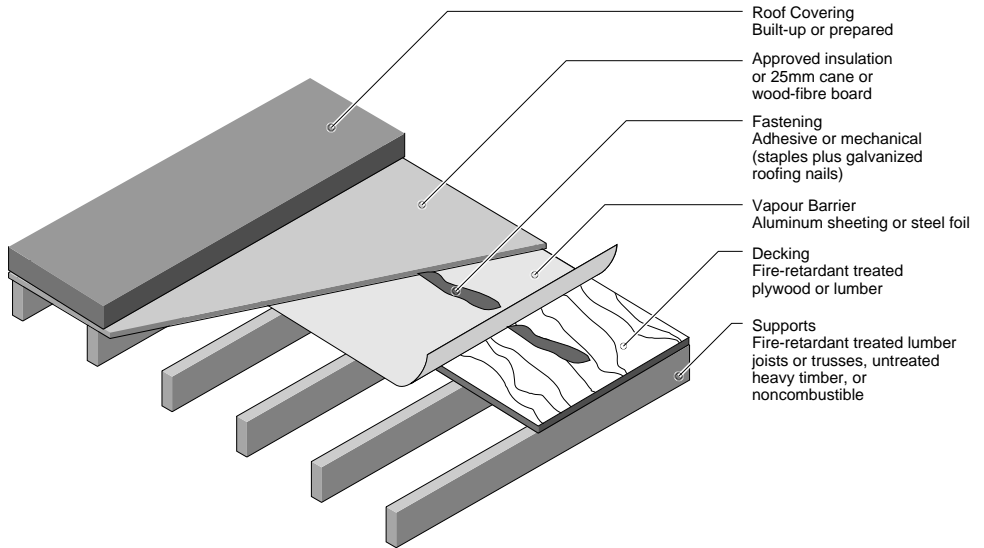

underside of the complete roof assembly not to exceed 3m in the first 10 minutes and not to exceed 4.2m in the total 30-minute test period.

3.1.14.2. For metal roof deck assemblies, this requirement only applies in unsprinklered buildings permitted to be of combustible construction where an unrated metal roof deck assembly is used in lieu of a rated combustible or FRTW roof assembly.

In such cases, any metal roof deck assembly, supporting combustible material above the deck that could propagate a fire below the deck, must meet the standard unless:

- the combustible material is protected on the underside by a thermal barrier
- the building is sprinklered
- the roof assembly has a fire-resistance rating of at least 45 minutes

FIRE-RETARDANT TREATED WOOD ROOF SYSTEMS

In certain unsprinklered one-storey buildings, the *NBCC* permits the use of a roof deck construction system, using FRTW, that meets the flame-spread performance standard originally developed for noncombustible roof assemblies.

3.1.14.1. The required fire-resistance rating of the roof assembly can be waived if the deck is constructed of FRTW and the assembly passes the requirements of CAN/ULC S126 (Figure 6.4).

For the fire-retardant treated roof system to meet the criteria of CAN/ULC-S126, the treated wood must have superior fire-retardant chemical retention so that it passes an extended flame-spread test. The flame-spread rating under the standard 10-minute exposure of the CAN/ULC-S102 test must be low enough (usually below 20), that the flame-spread rating will

not exceed 25 even with the test period extended to 30 minutes.

A roof deck system of FRTW may be supported by:

- metal and reinforced concrete beams or joists
- heavy timber supports
- FRTW joists or trusses

Unless wood members are heavy timber, which has an inherent capacity to withstand fire exposure, they must be fire-retardant treated. Experience shows that both lumber and plywood decking must have a minimum actual thickness of 19mm and both should be tongue and groove. Plywood decking, if not tongue and groove, must also have unsupported joints solidly backed with FRTW or plywood.

Figure 6.5 shows that the construction of roof assemblies using FRTW is similar to that of other types of roof assemblies, using a metallic vapor barrier membrane between the decking and the insulation. Usually 0.05mm aluminum sheeting is attached with an approved adhesive, although steel foil is also acceptable. Galvanized roof nails may be used to fasten the insulation to the vapor barrier which is then stapled to the deck.

FRTW or noncombustible ceilings may be attached to the underside of the system, with the resulting concealed spaces appropriately fire stopped.

FRTW roof assemblies are permitted as an alternative to roof

assemblies of noncombustible construction or ordinary wood-frame roof assemblies having a fire-resistance rating of 45 minutes. When used, however, the *NBCC* requires that, except for Group E and Group F, Div. 3 occupancies, the area of the building be half that which would be permitted if either of the other two types of roof assembly were used.

These building area limits are imposed where FRTW roofs are used because FRTW roof systems are generally open, subject to direct exposure from a fire below and consequently are less structurally stable during a fire.

As noted earlier, fire-retardant coated wood is not the same as FRTW and therefore is not permitted to be used under this requirement unless the system passes the extended 30-minute tunnel test (CAN/ULC-S126).

ROOF COVERINGS

Roof coverings have often been contributing factors in conflagrations. Most roof coverings, even today, are combustible by the very nature of the materials used for making them waterproof.

The objective of the *NBCC* is therefore to require that the risks associated with a roof covering be minimized for the type of building, its location and use.

There are two main types of product used for roof covering. First, there are the built-up roof membranes such as tar and gravel



that are laid in several operations and the more recent single-ply synthetic roofing materials. Second, there are the prepared coverings which include shingles, shakes, tiles and roll roofing that come from the manufacturer ready to install over the underlay and roof deck in one operation.

TESTING

3.1.15.1. The *NBCC* requires that roof coverings be tested in accordance with ULC standard

CAN/ULC-S107, Standard Methods of Fire Tests of Roof Coverings. These independent laboratory tests are for performance under external fire exposure.

The test illustrated in Figure 6.6 concentrates on three features:

- the ease with which the surface of the roof covering can be ignited by direct flame or by burning brands landing on the roof
- the extent of flame spread over the roof surface when a flame

FIGURE 6.6

Test apparatus for roof covering materials

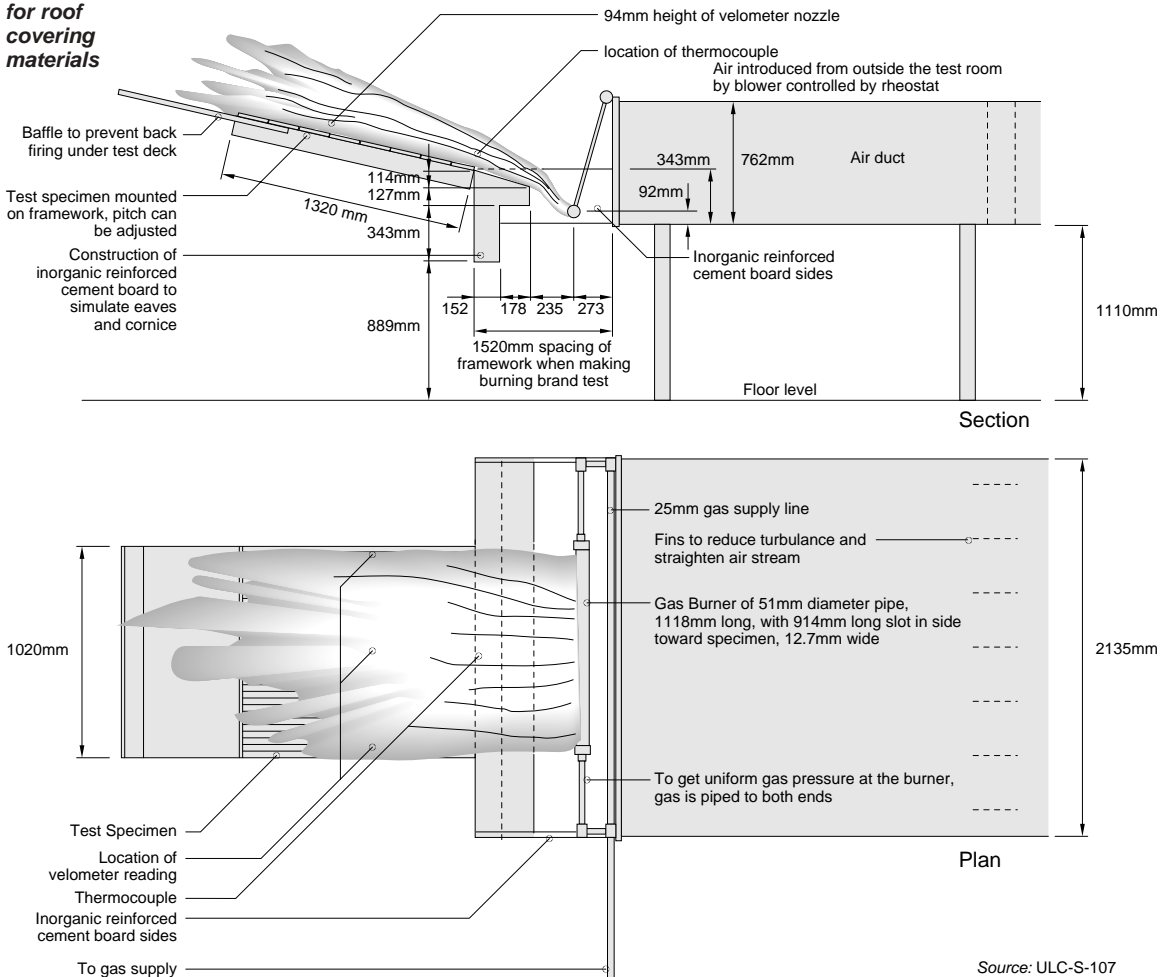

Source: ULC-S-107

is directed onto the lower edge of the roof deck

- the tendency for flaming or glowing pieces of the roof covering to break loose in flying brands that can be carried away from the roof onto other portions of the roof or onto other structures

The same test is applied to built-up and prepared types of roof coverings, conducted with the product installed on a metal roof deck. This determines, as nearly as possible, how it will perform when in place on a building and exposed to various degrees of fire severity.

After the product has been classified through initial testing, the testing laboratory continues to

monitor production, and makes periodic tests to ensure that original qualities and properties are maintained. A roof covering product that meets and maintains standards is qualified to carry a label issued by the testing laboratory designating its classification.

The standard classifies roof coverings in accordance with their performance:

- Class A perform well under severe fire test exposures
- Class B under moderately severe exposures
- Class C under less severe exposure

3.1.15.2. & 3.1.15.3.(1) The *NBCC* permits roof coverings that meet the Class C rating to be used

FIGURE 6.7

Wood shingle roof



for any building regulated by Part 3 of the Code, including any noncombustible building, regardless of height or area.

This C rating can be met easily using FRTW shakes or shingles, asphalt shingles, or roll roofing.

3.1.15.2.(2) Small assembly occupancy buildings not more than two storeys in building height and less than 1000 m² in building area do not require a classification for the roof covering. In these traditional cases, untreated wood shingles are acceptable if they are underlaid with a noncombustible material to reduce the potential for burn through with a burning brand (Figure 6.7).

2.5.3.1. As with other test methods, the authority having jurisdiction may accept the results of other fire test standards or of earlier versions of the referenced standards, provided it is satisfied that the results are equivalent to those obtained using CAN/ULC-S107.

The equivalent U.S. standards published for this application include:

- UL 790 *Tests for Fire Resistance of Roof Covering Materials*
- ASTM E-108 *Standard Test Methods for Fire Tests of Roof Coverings*
- NFPA 257 *Standard Methods of Fire Tests of Roof Coverings*

All of these test methods are very similar to the Canadian counterpart. The results of tests conducted in accordance with these other test standards should, therefore, be acceptable.

When approving a roof covering tested under an equivalent method, it is important that results of all individual types of fire tests required by the standard are provided.

These individual tests include assessment for:

- spread of flame
- burning brands
- intermittent flame exposure
- flying brand production

Very few changes have been made to these standards over the years and tests performed under earlier editions are still valid today.

It should be noted that in the case of FRTW shakes and shingles, accelerated weathering and actual long-term weathering tests are carried out to ensure that the effects of fire-retardant treatment will not be reduced by continuous exposure to weather.

Six decks are submitted to a standard rain test (ASTM D2898) and subsequently submitted to the various fire tests called for by the ULC standard. In addition, 15 test decks are weathered outside for periods of exposure of one, two, three, five and 10 years.

At the end of each time period, three of the decks are removed from the exposure site, conditioned as specified in the standard and submitted to the same fire tests. Fire retardant coatings typically cannot meet all the requirements of a Class C rating because of these extreme weathering tests.



Chapter Summary

The *NBCC* strictly regulates the flame-spread potential of interior finishes because their contribution to fire growth can significantly affect the ability of occupants to safely evacuate the building.

The flame-spread limits are essentially dependent on the importance of the area under consideration with regard to evacuation.

The limits contained in the *NBCC* permit extensive use of untreated wood finishes. Fire-retardant treated wood can offer attractive and economical solutions in areas where flame-spread limits do not permit the use of untreated wood products.

The use of FRTW can also waive fire-resistance requirements for roof assemblies in some cases.

The *NBCC* also regulates the flame-spread potential of roofing materials, as well as other properties including their propensity to be ignited by burning brands, to reduce the hazard of fire spreading from roof to roof.





7

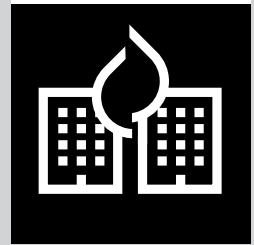

Fire Spread Between Buildings

7.1	General Information	227
	The St. Lawrence Burns	227
7.2	Objectives and Assumptions	229
7.3	Limiting Distance	233
	Area of Exposing Building Face	237
	Construction of Exposing Building Faces	238
7.4	Exceptions to Spatial Requirements	243
	Unlimited Unprotected Openings in Building Faces	243
	Reduced Fire Resistance in Low Fire Load Buildings	243
	Increased Area of Openings for Wired Glass	244
	Equivalent Opening Factor for Exterior Walls	244
7.5	Exposure Protection Within a Building	245
	Horizontal Fire Spread Between Compartments	245
	Vertical Fire Spread Between Floors	247
	Fire Exposure of Exit Facilities	249
7.6	Examples of Spatial Separation Calculations	251
	Example 7.1	251
	Example 7.2	254
	Example 7.3	256
	Example 7.4	261
	Chapter Summary	264



7.1 General Information

A fire in one building is always a threat to neighboring buildings. Thermal radiation or convection through windows or other unprotected openings could ignite combustible materials in or on a nearby building.

To reduce this risk, a number of measures are used. These include:

- limiting the number and size of openings in the building face
- requiring buildings to be noncombustible
- requiring buildings to be clad with noncombustible siding
- separating the buildings by a clear space

The measures chosen depend on the likely severity of the fire and radiation from the face of the building where the fire originates.

This chapter explains the objective and rationale behind *NBCC* requirements for preventing fire spread between buildings. As well, examples of calculations for spatial separations are provided.

The proximity of buildings is controlled to reduce potential for conflagrations

THE ST. LAWRENCE BURNS

Early *NBCC* requirements for spatial separation of buildings were based on British and Japanese studies performed during post-war years. Most of the data on the relationship between spatial separation and tolerable radiation levels evolved from Canadian experiments referred to as the St. Lawrence Burns.

When the St. Lawrence Seaway was under development in the 1950s, a number of small towns near the existing shoreline had to be expropriated and demolished. The National Research Council's Division of Building Research (now the Institute for Research in Construction) saw the abandoned buildings as ideal for fire research experiments.

The burns, conducted in the winter of 1958, were designed to observe critical fire development factors such as:

- its effect on the survival of occupants
- its effect on the spread of fire by radiation
- the effect of ventilation rates in the room of fire origin



The objectives of the study were to determine at what distances intensities of radiation would be sufficient to ignite combustible materials in adjacent structures, and the intensity of thermal radiation at window openings.

The study concluded that:

- the radiation levels from buildings with combustible interior finishes were double those where noncombustible interior finishes were used
- peak radiation levels at some distance from the building were found to be directly related to the percentage of openings in the exterior wall
- radiation levels during the first 16 minutes rarely exceeded 25% of maximum radiation levels. In most cases, radiation levels were only about 20% of maximum after 20 minutes
- maximum radiation levels were not greatly affected by the type of exterior cladding.

These findings are the basis of *NBCC* requirements that apply today.

7.2 Objectives and Assumptions

The objective of the *NBCC* requirements for spatial separation and exposure protection of buildings is to prevent fire spread between buildings.

Spatial separation, though a primary means of attaining this objective, is not always the best method. In major urban areas, where land is expensive, large setbacks from property lines will have a serious economic impact on a project.

The level of thermal radiation emitted from the face of a burning building is directly related to the number and size of the openings in the building face. Therefore, a limit on such openings will reduce radiation and allow buildings to be closer together.

Buildings could be situated very close together if exterior walls facing neighboring properties were constructed as firewalls, and had no openings which could emit radiation. It is more common, however, to combine spatial separation with control on the amount and size of openings in the exterior wall in order to prevent fire spread between buildings (Figure 7.1).

The *NBCC* generally uses the term unprotected opening to refer to doors, windows or other openings in a building face that are not protected with a closure (see Chapter 5 for an explanation of closure).

Normally, openings through the exterior wall of a building (such as windows) are not protected by

FIGURE 7.1

Spatial separation determines both wall construction and amount of openings permitted



closures because they are neither practical nor economical.

By definition, however, an unprotected opening is also any part of the building face that has a lesser fire-resistance rating than that required for the exposing building face. The exposing building face is an exterior wall of a building that could expose another building to thermal radiation and thereby cause fire to spread from one building to another.

3.2.3. The *NBCC* limits the maximum area of unprotected openings permitted in an exposing building face, expressed as a percentage of the area of the exposing building face.

The spatial separation values are based on the following assumptions:

- The exposing building face is a rectangle in a vertical plane.
- The exposing building face is parallel to the exposed surface.
- The fire department should be able to respond and set up operations within 15 to 20 minutes of the outbreak of fire.
- The exposing building face is a grey radiator.

Grey radiator means that the unprotected openings are assumed to be uniformly distributed across the building face and that, during a fire, heat will be uniformly emitted from the entire surface at a rate proportional to the ratio of the total area of unprotected openings to the area of the exposing building face.

As mentioned in Section 7.1, radiation levels within the first 20 minutes are only about 20% of the maximum radiation levels. Spatial separations are based on the assumption that the fire department will be at the scene to control exposure after the first 20 minutes of the fire.

3.2.3.1.(5) If firefighting services cannot reach a fire scene within 10 minutes of an alarm being received (which could be the case in isolated rural areas) the *NBCC* requires that the limiting distance be doubled for buildings that are not sprinklered throughout. Because radiant energy is inversely proportional to distance squared, the increased separation distance reduces the exposure to acceptable levels.

For a given limiting distance and total area of exposing building face, the percentage of permitted unprotected openings is determined by the geometry of the building face. This affects the total amount of heat that will be radiated.

The *NBCC* bases the maximum permitted area of unprotected openings for unsprinklered buildings on the aspect ratio of the exposing building face. This ratio is expressed as either length/height or height/length.

3.2.3.1. In the 1995 *NBCC*, different sets of spatial separation tables apply for sprinklered and unsprinklered buildings. It is assumed that the entire exterior wall face of a sprinklered build-

ing will not become involved in a fire. This is because the sprinkler system limits the maximum size of a fire.

Consequently, the need to consider the effect of the aspect ratio of the height and length of the building is removed. Also, it is expected that fires in sprinklered buildings will not involve the entire exterior wall.

The maximum area of the exterior wall face that need be considered in determining spatial separations for any sprinklered building is:

- 200m² for Group E and Group F, Division 1 and 2 occupancies
- 150m² for all other occupancies

The maximum area of exposing building face used for unsprinklered buildings is 2000m².

These maximum areas were determined on the basis of the applicable engineering designs allowed by the NFPA sprinkler standards. In the design standards, the expected size of the fire in a sprinklered building is assumed for each occupancy. It is assumed that the maximum floor area that will be involved in a fire in a sprinklered building is 465m² and the maximum linear dimension is 26m.

The maximum exposing building face areas for sprinklered buildings were determined using these smaller base floor areas and assuming that the sprinklers limit fire to a single storey.

3.2.3.1. As a result, the 1995 *NBCC*, significantly reduces the minimum spatial separation requirements for sprinklered buildings and allows for greater amounts of unprotected openings to be present. The doubling of the limiting distance for delayed fire department response no longer applies to buildings that are sprinklered throughout.

3.2.3.7 As well, the construction and cladding requirements for the exterior walls are now applied after the effect of sprinklers are considered by using the spatial separation tables specifically applicable to sprinklered buildings.

3.2.3.11 The credit normally applied for the use of wired glass or glass block in exterior wall openings is not applied in sprinklered buildings. This is because the impact of their use would not be significant since the fire in the building is controlled or suppressed by the sprinklers.



7.3 Limiting Distance

Consider two unsprinklered buildings on lots A and B (Figure 7.2.)

The owner of Building A, Situation A, constructs the first building and locates it next to the property line with windows covering 80% of the wall adjacent the property line. This is not in accordance with spatial separation rules.

When owner B comes to construct a building, the authority having

jurisdiction would impose a lengthy set-back or restrictions on openings and wall construction materials to offset the proximity of Building A to the property line. Obviously, this unfairly penalizes the owner of the building on lot B.

On the other hand, if the construction and number of openings for both buildings had been established on the basis of the lot line (Situation B), both buildings

FIGURE 7.2

Limiting Distance

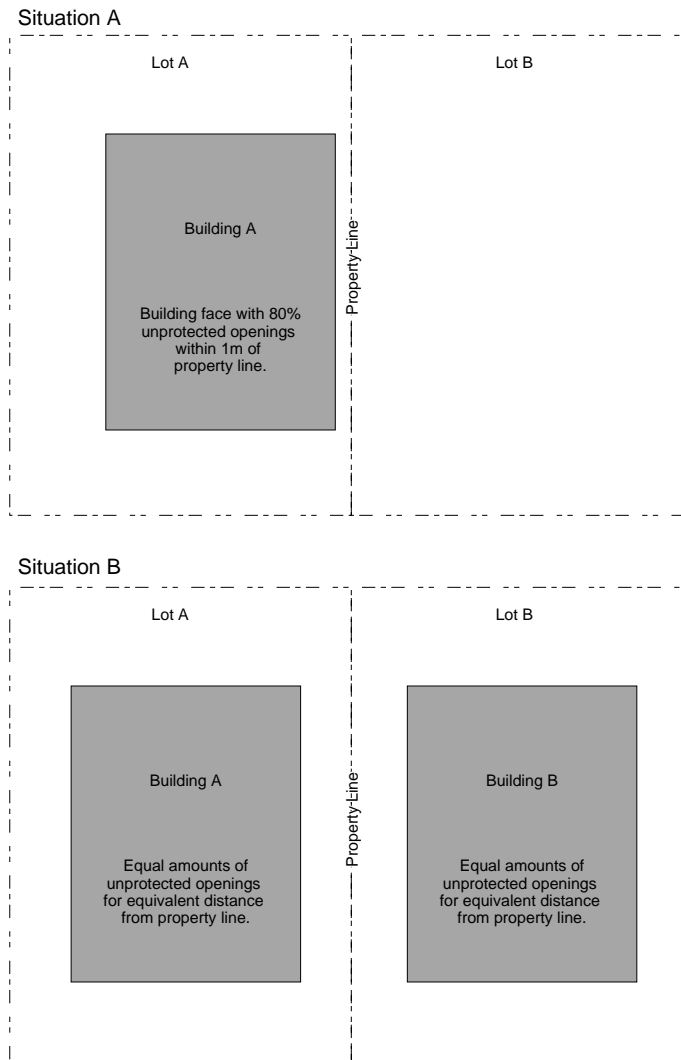

could have the same amount of openings for an equivalent distance from the property line.

The *NBCC* only regulates a building under construction, independently of buildings on adjacent sites. Therefore, there must be a reference line for calculating spatial separation and the area of unprotected openings permitted for each building.

The distance which must be maintained from the reference line is referred to as the limiting distance.

This limiting distance is calculated from the exposing building face to one of:

- the property line
- the centre line of a street or public thoroughfare
- an assumed line between two buildings or fire compartments on the same property

Note that the assumed line does not have to be equidistant from the two buildings or fire compartments.

The distance required between a building and the reference line is proportional to the amount of unprotected openings in its exposing building face. Inversely, the area of unprotected openings permitted in an exposing building face is reduced as the distance to the reference line decreases.

TABLES 3.2.3.1.A. & 3.2.3.1.B.

The application of the *NBCC* requirements for spatial separation is simplified by Tables 3.2.3.1.A. and 3.2.3.1.B. for unsprinklered buildings.

TABLES 3.2.3.1.C. & 3.2.3.1.D. As mentioned, the spatial separation requirements are easier to apply and are significantly less restrictive for sprinklered buildings than for unsprinklered buildings. Tables 3.2.3.1.C and 3.2.3.1.D. contain the values for permitted unprotected openings based on limiting distance and the size of the exposing building face.

Separate tables are used for mercantile and high-hazard industrial occupancies. These occupancies are assumed to have a larger combustible content which would result in higher thermal radiation levels.

In buildings where these higher hazard occupancies are found, the percentage of unprotected openings permitted for a given limiting distance is approximately half of that permitted for other occupancies.

In sprinklered buildings, the maximum limiting distance needed to permit 100% unprotected openings is:

- 15m for any Group E or Group F, Div. 1 or 2 occupancies
- 9m for the other occupancies

In unsprinklered buildings, these distances can reach as high as 70m and 50m respectively for buildings having large exposing building faces.

The tabulated values for limiting distance are based on the assumption that the exposing building face is a rectangle in a vertical plane, and the exposed surface lies

in a parallel plane. This assumption simplifies the application of spatial separation requirements with little loss in accuracy.

3.2.3.1.(3) Irregularly shaped building faces must be projected onto a vertical plane. This vertical plane must be positioned so that no portion of the building extends horizontally beyond it. The limiting distance is then measured from this vertical plane to the real or reference line.

The actual area of unprotected openings is taken as the area of unprotected openings in the exterior wall projected onto the plane.

3.2.3.1.(4) If a building has all the unprotected openings located in wall sections which are set back from the front face, then a two-stage calculation can be made (Figure 7.3).

The first stage determines the construction requirements for the exterior wall of the building (see Construction of Exposing Building Faces). First, the permissible area of unprotected openings at the plane of the external face of the building closest to the property line is determined. The permitted area of unprotected openings is expressed as a percentage of the area of the projection of the building face. This percentage is then used to determine the type of construction and FRR.

The second stage determines the percentage of unprotected openings permitted. The permissible area of unprotected openings is calculated using the distance to the plane of the recessed openings.

The percentage of unprotected openings actually permitted will be greater because of the increased limiting distance. The Appendix to the *NBCC* 1995 further illustrates how this calculation is made.

With this *NBCC* calculation method, a small blank wall projection close to the property line may govern the type of construction permitted for an entire building face.

The *NBCC* permits other methods of evaluating spatial separation requirements to be used. Information on these methods is contained in the Bibliography References 37, 38, 55, 85, 86 and 87 in the Appendix of this book.

Interpolation of the *NBCC* tables is permitted when the limiting distance or the percentage of openings falls between the values in the tables.

Interpolation is not permitted in unsprinklered buildings, however, for a limiting distance between 0 and 1.2m because flames can project horizontally 1 to 1.2m beyond an opening.

3.2.3.5. The *NBCC* requires that openings in an exposing building face that has a limiting distance of less than 1.2m be protected by closures. Wired glass and glass blocks are not permitted as closures for this application because it is assumed that they only reduce radiation by one half. This reduction is insufficient to control the spread of fire to neighboring buildings where the limiting distance is less than 1.2m.



FIGURE 7.3

Limiting distance and recessed opening

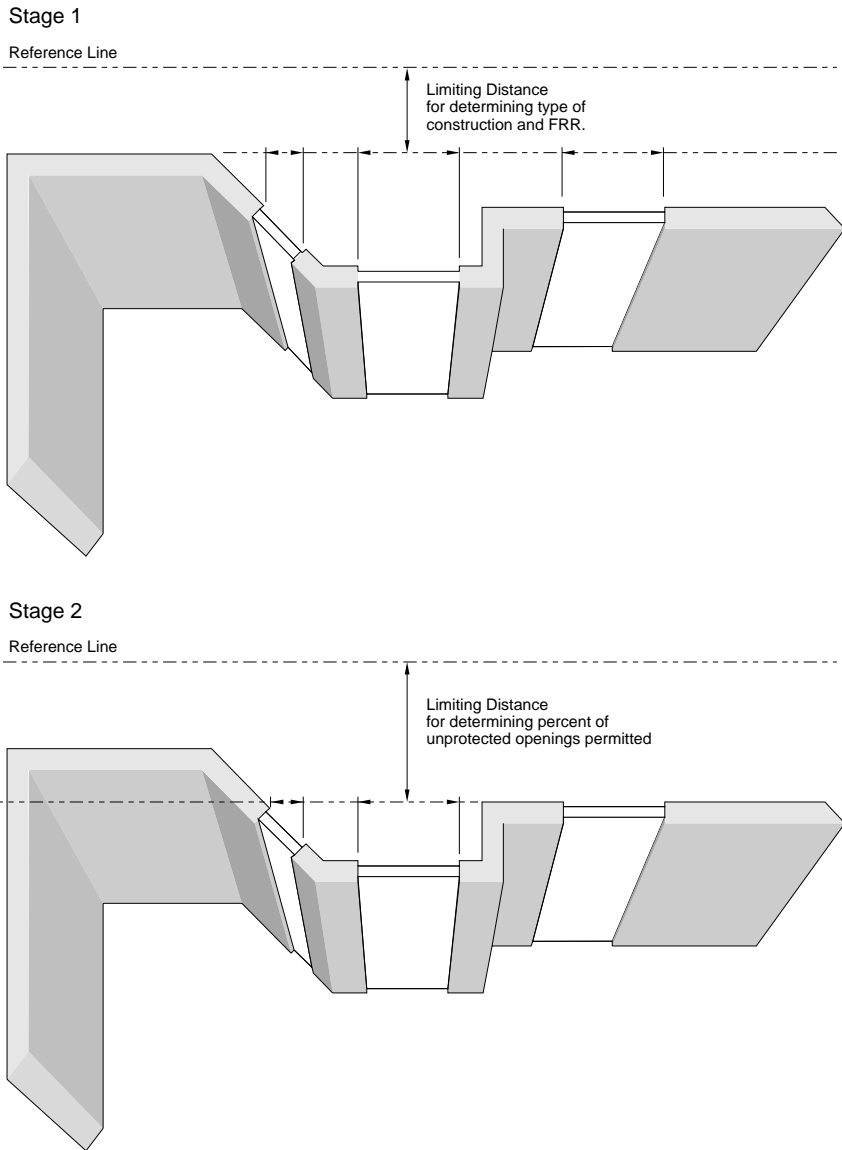
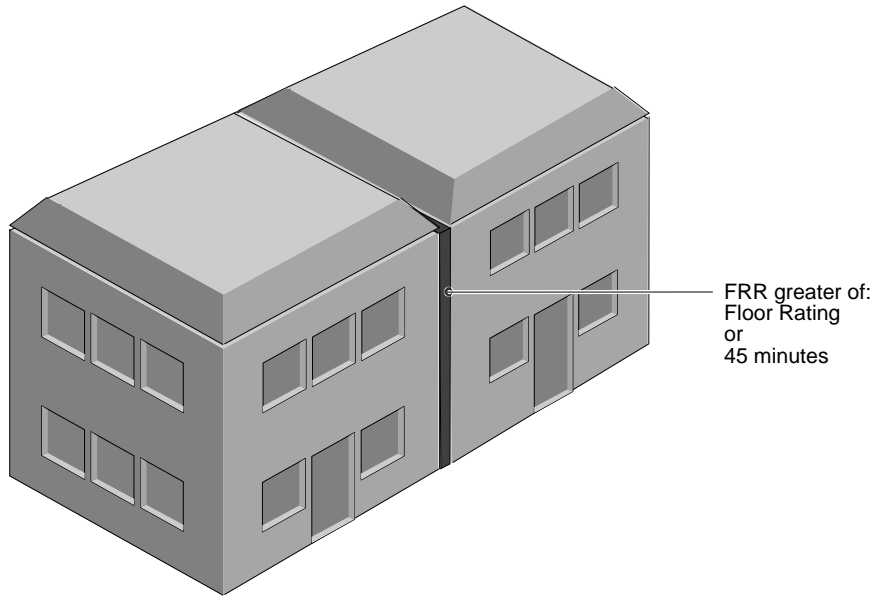

FIGURE 7.4

Compartmentation and exposing building face

Mercantile, High and Medium Hazard Industries

Notes:

1. With vertical fire separation continuous from front to back of the building, the two sections of exterior wall can be considered separate exposing building faces.
2. If floor assemblies are continuous fire separations with openings protected, the area of the exposing building faces can be reduced further.

AREA OF EXPOSING BUILDING FACE

3.2.3.2.(1) The area of an exposing building face is typically measured vertically from ground level to the ceiling of the top storey, and horizontally from the interior surfaces of the exterior walls.

3.2.3.2.(2) Other measures are used for buildings which are divided into fire compartments designed to control the movement of fire within the building. The *NBCC* permits the exposing building face to be calculated on the basis of individual fire compartments.

Measurements are made vertically between interior surfaces of horizontal fire separations and horizontally between interior surfaces of walls constructed as fire separations.

Creating fire compartments in a floor area by the use of interior fire separations will reduce the area of the exposing building face radiating heat in a fire situation.

This reduction in the area of the exposing building face can permit a greater area of unprotected openings. This in turn reduces the requirements for exterior wall construction.

The fire separations bounding each compartment must be continuous both vertically and horizontally (Figure 7.4).

3.2.3.2. For these provisions to apply, each fire compartment must be completely separated from other parts of the building by fire separations that meet the following conditions:

- For Group A, B, C, D, or Group F, Division 3 occupancies, the fire-resistance rating must be at least one hour, unless the floor assembly is permitted to be less than one hour by 3.2.2, in which case the minimum FRR is 45 minutes.
- For Group E or Group F, Division 1 and 2 occupancies, the fire separations around a fire compartment must be at least 45 minutes and must not be less than the FRR required for the floors above and below the compartment.

Where combustible construction is permitted, parts of buildings (such as rooms or suites) can be considered as fire compartments when surrounded by 45-minute rated wood-frame walls and floors. Wood assemblies can be designed to provide up to a two-hour fire-resistance rating.

3.2.3.2.(6) In sprinklered buildings containing interconnected floor spaces, each storey is permitted to be considered as a separate fire compartment. The presence of the large openings through the

floor assemblies can be ignored in this case as it is assumed that the sprinkler protection in the building will control fire spread from floor to floor.

CONSTRUCTION OF EXPOSING BUILDING FACES

Where the percentage of permitted unprotected openings is restricted, the balance of the wall must have some fire endurance to ensure that the radiating area does not increase during a fire.

Should an exterior wall fail in the early stages of a fire, the area of unprotected openings could suddenly become 100% of the exposing building face. If the limiting distance were based on a permitted area of unprotected openings of 10%, this distance would obviously now be of marginal value in preventing the spread of fire.

Note that the permissible area of unprotected openings may consist of unrated, unrestricted wall construction, doors and windows (Figure 7.5).

3.2.3.7. Table 7.1 summarizes the *NBCC* requirements for the construction type and fire-resistance rating for the exposing building face. The need for noncombustible construction and cladding and the requirements for fire resistance relax as the permitted area of unprotected openings increases.

TABLE 7.1

Construction of exterior walls

Occupancy Classification	Unprotected Openings Permitted, percent	Minimum Fire-Resistance Rating for Exposing Building Face, hours	Wall Construction	Exterior Cladding
A, B, C, D and F-3	0 to 10	1	Noncombustible	Noncombustible
	> 10 to 25	1	Combustible ¹ or Noncombustible ³	Noncombustible ²
	> 25 to < 100	3/4	Combustible ¹ or Noncombustible ³	Combustible ¹ or Noncombustible ²
	100	None Required	Combustible ¹ or Noncombustible ³	Combustible ¹ or Noncombustible ²
E, F-1 and F-2	0 to 10	2	Noncombustible	Noncombustible
	> 10 to 25	2	Combustible ¹ or Noncombustible ³	Noncombustible ²
	> 25 to < 100	1	Combustible ¹ or Noncombustible ³	Combustible ¹ or Noncombustible ²
	100	None Required	Combustible ¹ or Noncombustible ³	Combustible ¹ or Noncombustible ²

Notes:

1. If building is permitted to be of combustible construction by Subsection 3.2.2.
2. Combustible cladding assembly can be used on noncombustible buildings if cladding meets the vertical flame spread limits of Article 3.1.5.5.
3. Wood stud framing can be used in non-loadbearing portions of exterior walls of noncombustible buildings when permitted area of openings exceeds 10% (see Chapter 2).

FIGURE 7.5

Walls as unprotected openings

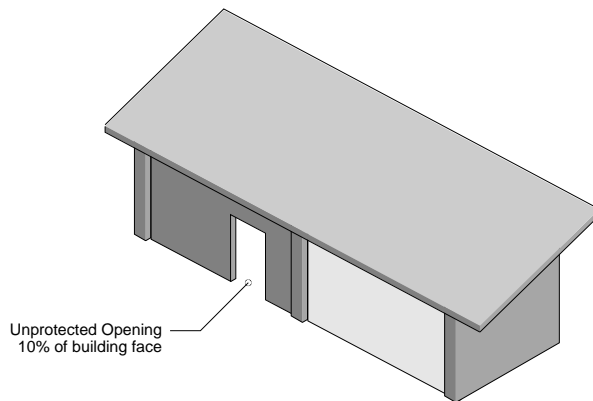

If 60% of Exposed Building Face is permitted to be unprotected openings, and in this situation 10% is an unprotected opening, 50% (lighter shaded area) may be unrestricted wall construction.



There is little point in requiring noncombustible construction and cladding for a building face that is permitted to have 100% openings. In such cases, spatial separation rather than structural confinement becomes the controlling factor.

3.1.7.3.(3) As noted in Chapter 5, the fire-resistance rating for an exterior wall assembly is required from the inside only. A fire-resistance rating from the outside is not required, regardless of the limiting distance specified or the percent of unprotected openings permitted.

3.2.3.3. To simplify the calculation of the area of the exposing building face, the area of a gable end in an attic does not have to be included. However, the gable must be constructed to the same requirements as the exposing building face below. This is intended to inhibit fire from reaching the concealed attic space, igniting the gable end wall, and increasing the radiation.

Structural members, such as beams, columns or arches, that are entirely outside the exterior building face or that are cantilevered from the building interior to the exterior, are not considered part of the exposing building face. The limiting distance is measured from the wall rather than from the furthest horizontal projection of such structural members.

3.2.3.8.(1) No protection from exterior fires is needed for an exterior structural member that is at least 3m from a property line or from the centre line of a public thoroughfare. At this distance, it is unlikely that the member will be exposed to a fire in a neighboring building of sufficient intensity to cause structural collapse.

Structural members of heavy timber have inherent fire resistance and need not be covered to protect them from exterior or interior fires.

3.2.3.8.(2) When structural members are less than 3m from a property line, they must have a fire-resistance rating of not less than that required for interior loadbearing members, but not less than one hour (Figure 7.6).

3.2.3.6. *NBCC* requires that combustible projections such as balconies and eaves on the exterior of buildings be 1.2m from the property line or 2.4m from a combustible projection on another building on the same property.

This ensures that the addition of combustible balconies on a building face does not negate the protection offered by this spatial separation.

FIGURE 7.6

Limiting distance for exterior structural members

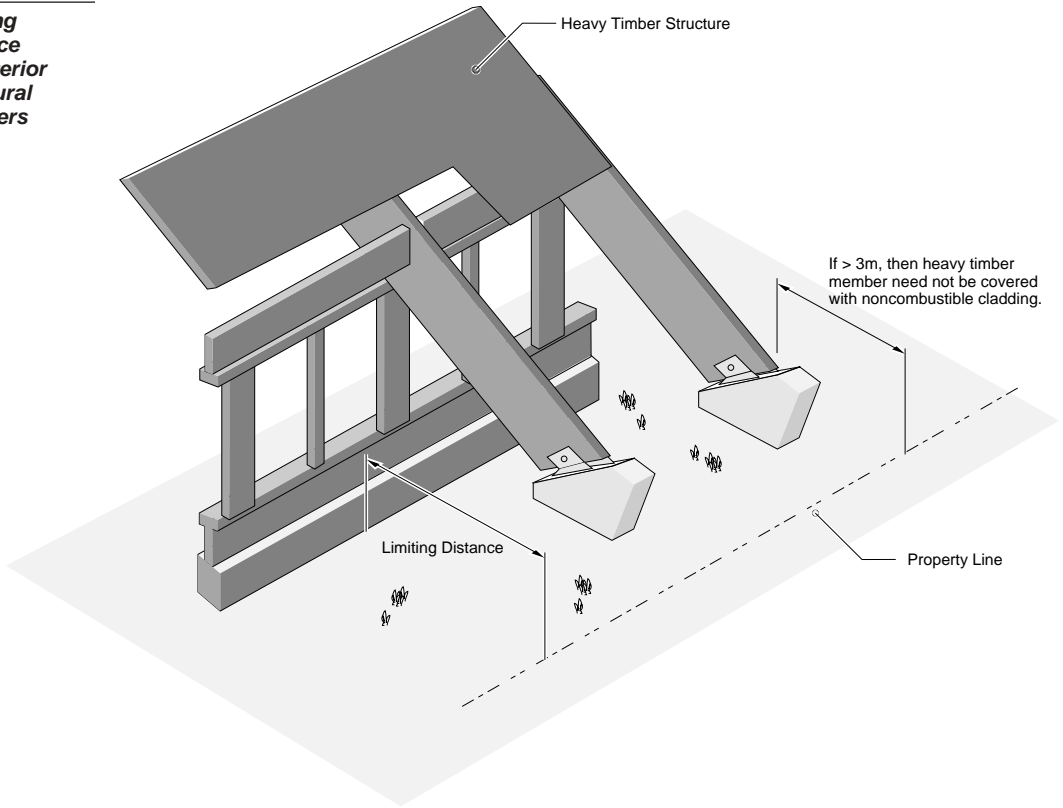

7.4 Exceptions to Spatial Separation Requirements

The *NBCC* allows several exceptions to the requirements for spatial separation and exposure protection.

UNLIMITED UNPROTECTED OPENINGS IN BUILDING FACES

3.2.3.9.(2) If the limiting distance is at least 9m, a fire compartment at street level may have unlimited unprotected openings in the building face facing the street, regardless of the area of unprotected openings otherwise permitted.

This exception was granted to allow traditional store fronts in mercantile occupancies but today applies to any occupancy at street

level. Exposure hazard to buildings on the other side an 18m wide street is considered minimal because of easy firefighting access (Figure 7.7).

3.2.3.9.(1) An open-air parking garage is permitted to have unlimited openings on every storey provided a limiting distance of 3m is maintained. Tests have shown that fire exposure from open-air garages is minimal.

REDUCED FIRE RESISTANCE IN LOW FIRE LOAD BUILDINGS

3.2.3.10. One-storey, low-hazard industrial buildings with a low fire load, such as power generating

FIGURE 7.7
Unlimited unprotected openings at street level

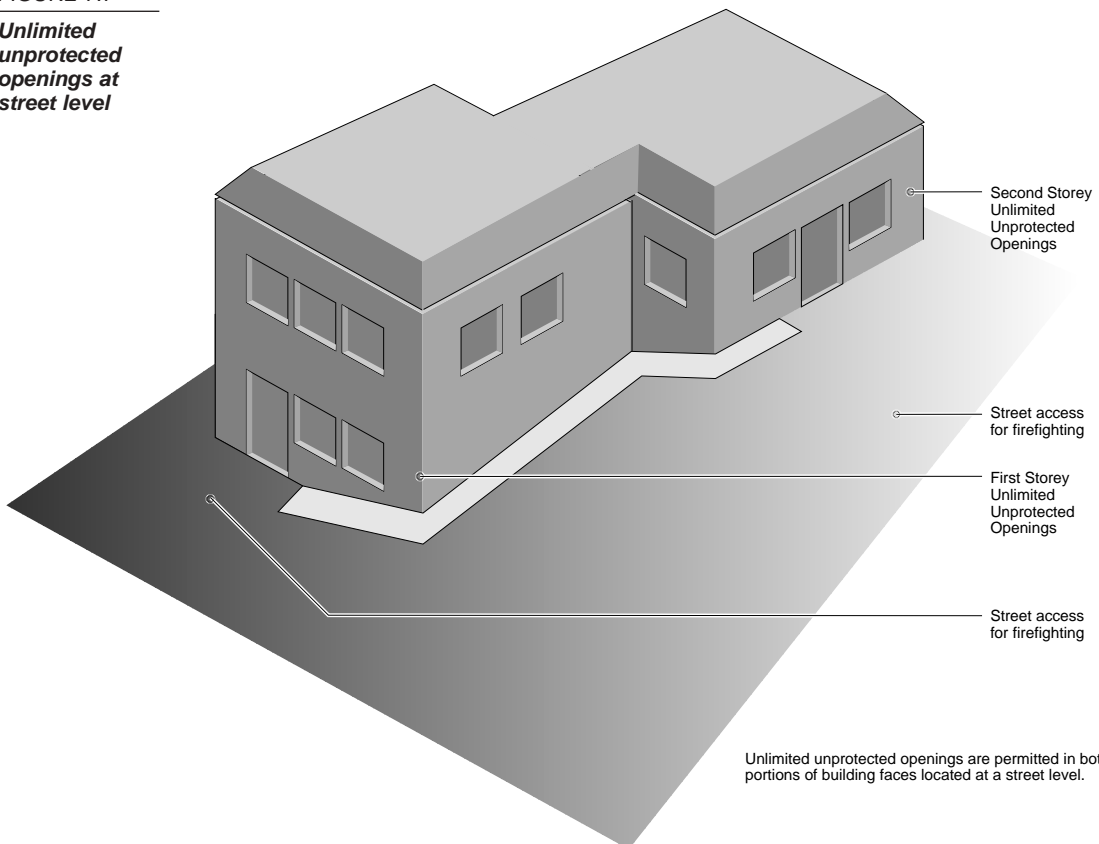

Unlimited unprotected openings are permitted in both portions of building faces located at a street level.



plants and plants that manufacture masonry products, are also exempt from most spatial separation requirements because they are considered very low fire hazards.

The construction of such buildings and their contents are predominantly noncombustible. If the limiting distance is at least 3m, no fire-resistance rating is required for nonloadbearing walls of noncombustible construction.

INCREASED AREA OF OPENINGS FOR WIRED GLASS

3.2.3.11. In unsprinklered buildings, the area of unprotected openings in an exposing building face is permitted to be doubled if they are fitted with wired glass or glass blocks. These windows reduce radiation levels by approximately 50%.

3.2.3.7. The construction requirements for exposing building faces shown in Table 7.1 must be met before the area of unprotected openings is doubled.

TABLES 3.2.3.1.C. & 3.2.3.1.D.

The 1995 *NBCC* does not permit the doubling of permitted unprotected openings for sprinklered buildings (as was the case in previous editions). The specific spatial separation Tables for sprinklered buildings include the sprinkler reduction factor.

The reduction for wired glass or glass block does not apply for sprinklered buildings because the maximum reduction in radiant heat expected from the window has already been accounted for in recognition of the effect of the sprinklers.

EQUIVALENT OPENING FACTOR FOR EXTERIOR WALLS

3.2.3.1.(6) The *NBCC* requirement for an equivalent opening factor often leads to confusion. It was introduced specifically for manufactured steel buildings with uninsulated metal sides; primarily storage buildings.

Even though manufactured steel buildings are noncombustible, the sides can become red-hot when exposed to a fire. In these cases, the assembly fails the fire test and the entire wall surface would be considered as an unprotected opening.

However, these walls are normally built with few openings, so that when the building collapses the fire tends to be smothered. To treat these buildings in the same way as those with 100% unprotected openings, simply because of heat transmission through the walls, would be an unnecessary restriction. The correction for increased radiation increases the area of unprotected openings above actual values.

3.1.7.2 The *NBCC* therefore waives the temperature transmission criteria for exterior walls, with a limiting distance of at least 1.2m providing a correction is made for increased radiation.

Data from fire-resistance tests on sample assemblies are required for the calculation. The temperature of the unexposed wall surface at the time the required FRR is reached is required. This must be obtained from the testing agency.

7.5 Exposure Protection Within a Building

Most spatial separation requirements are intended to prevent the spread of fire from one building to another.

The *NBCC* also contains requirements addressing the potential for fire spread from one fire compartment to another, within the same building. Fire may spread through openings in the exterior or interior walls or floors or ceilings.

Fire exposure of exit facilities from the exterior of the building is also a potential hazard which must be avoided.

Within a building, floors and walls are constructed as fire separations to impede the spread of fire from one part of the building to another. Fire separations are also constructed to protect building exits. The function of the fire separation can be defeated by the presence of openings in the exterior envelope of the building.

Fire can bypass fire separations as follows:

- compartment to compartment horizontal spread via unprotected openings
- floor to floor vertical spread via skylights and windows
- floor to floor vertical spread via window openings
- compartment to compartment horizontal spread via soffits

Exit facilities can be exposed to fire by the following:

- exterior openings in exit enclosures
- exterior exit doors
- unenclosed exterior exit stairs

The *NBCC* specifies additional requirements for each case to reduce the possibility of fire spread or fire exposure from exterior openings in the building.

HORIZONTAL FIRE SPREAD BETWEEN COMPARTMENTS

Unprotected Openings

The potential for horizontal fire spread between fire compartments exists where exterior walls meet at an angle. Flames and radiation projecting from an unprotected opening in one fire compartment can impinge on an unprotected opening in another fire compartment.

3.2.3.13. The *NBCC* considers that there is a potential for fire spread between separate fire compartments when the angle between the exterior walls of a building is 135° or less and the walls contain unprotected openings in close proximity to one another.

The *NBCC* sets a minimum distance, D_0 , which must separate openings in these cases. Also, the construction of the portion of the wall between the openings is required to have a fire-resistance rating at least equal to



FIGURE 7.8

Separation of openings in exterior walls

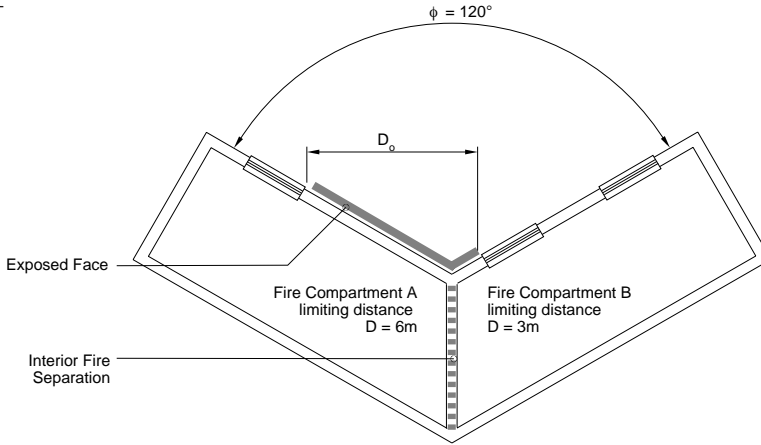

$$D_0 \geq 2D_{\text{max}} - [\phi/90 \times D_{\text{max}}]$$

$$D_0 \geq 2(6) - [120/90 \times 6]$$

$$D_0 = 4\text{m}$$

Notes:

1. Fire-resistance rating of exposed face within the distance D_0 must be at least equal to that of the interior fire separation.
2. No openings are permitted within the distance D_0 .

that required for the internal fire separation between the two fire compartments. (Figure 7.8)

This requirement does not apply to exterior exit doors or openings in the exterior wall of an exit enclosure exposed to openings in adjacent exterior walls. (See Fire Exposure of Exit Facilities page 249)

Where the openings are in separate fire compartments in the same building, the requirements do not apply if the building is sprinklered. If only one compartment is sprinklered, the requirements must be met.

If the fire compartments are in separate buildings, on opposite

sides of a firewall, the requirements still apply even when one or both of the buildings or compartments are sprinklered.

Soffits

3.2.3.15.(1) NBCC requirements for the protection of soffits limit openings in overhanging roof soffits where an unprotected window or exterior door opening is less than 2.5m below the soffit.

This requirement applies only in residential and certain institutional occupancies where a common attic or roof space is located above more than two dwelling units or patients' bedrooms. It is intended to impede the spread of fire from one suite

FIGURE 7.9

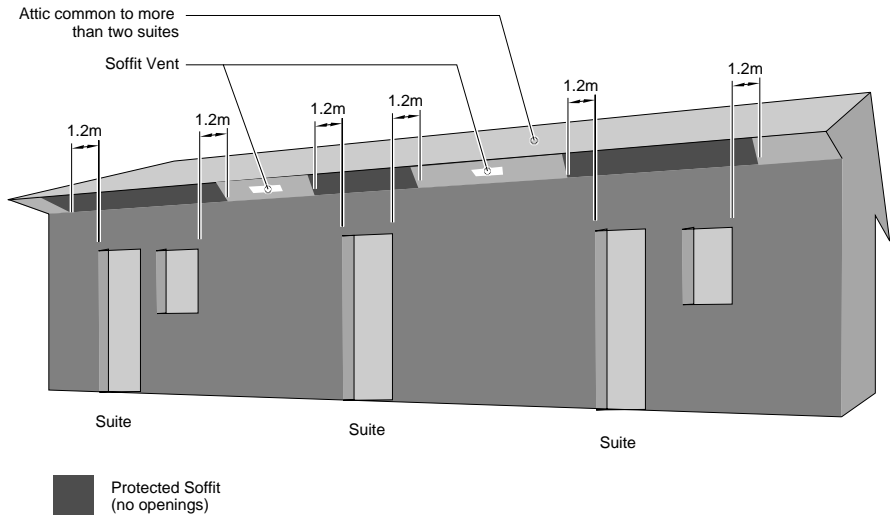
Protection of soffits

through soffit openings to the roof space, and down into other suites.

Materials that may be used to protect the soffit include:

- 11mm plywood
- 12.5mm oriented strandboard or waferboard
- 11mm lumber
- any noncombustible material at least 0.38mm thick having a melting point of at least 650°C

The soffit protection must extend on either side of the wall opening below (Figure 7.9).

The requirements for soffit protection are waived if:

- the roof overhang is fire stopped from the remainder of the roof space **3.2.3.15.(3)**
- the compartment containing the window and door openings is sprinklered **3.2.3.15.(4)**

The applicable sprinkler installation standards, NFPA 13 and

NFPA 13R, permit certain rooms such as closets and bathrooms to be un-sprinklered. However, those rooms must be sprinklered, to permit protection of the soffit to be waived.

VERTICAL FIRE SPREAD BETWEEN FLOORS

Skylights

Buildings with portions having different building heights can present a potential for fire spread where two fire compartments meet at different elevations.

3.2.3.14. The location of skylights in the roof assembly of the lower portion of a building is restricted when there are openings in the adjacent exterior wall of the higher portion. The provision of sprinkler protection in the lower portion reduces the potential for a severe fire and consequently allows unrestricted use of skylights (Figure 7.10).

FIGURE 7.10

Separation of window openings and skylights

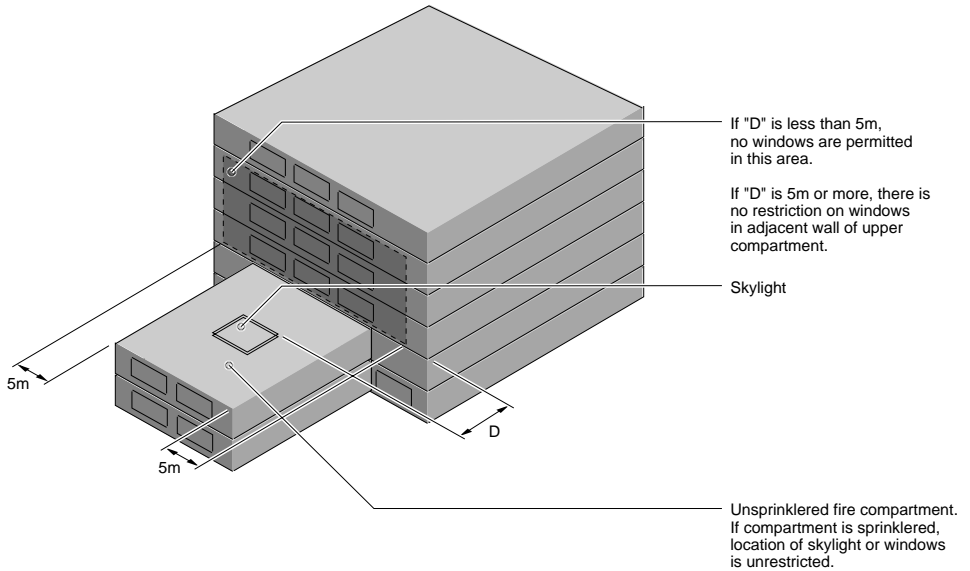

(Source: Commentary on Part 3 of *National Building Code of Canada 1995*, National Research Council Canada)

Window Openings

The *NBCC* recognizes the potential for fire spread storey to storey through openings in exterior walls of commercial and industrial buildings (Group E and Group F, Divisions 1 & 2) due to the substantial fire load usually contained in such buildings.

Once the fire has breached an opening in the exterior wall of a store or factory, flames projecting from that window could leap upward through an opening to another compartment.

3.2.3.16.(1) For unsprinklered buildings, the *NBCC* requires such openings in the exterior walls of fire compartments to be separated by a horizontal canopy. This canopy must:

- be at least 1m deep
- have the same fire resistance as the floor assembly, but need not be more than one hour

Alternatively, the upper exterior wall may be recessed at least 1m behind the exterior wall containing the opening in the lower storey.

In the previous edition of the *NBCC*, a vertical apron/spandrel or a canopy was considered acceptable protection against potential fire spread storey to storey. In the 1995 *NBCC*, this apron/spandrel option no longer applies. Recent fire research and fire loss experience has shown that even a 1m noncombustible vertical spandrel between the windows will not prevent storey to storey fire spread.

3.2.3.16.(3) In the previous edition of the *NBCC*, the apron/spandrel or canopy was required in all affected buildings. It now has been recognized that, if a building is sprinklered, the exposure is reduced and the canopy/setback requirements need not apply.

Since most multi-storey commercial and industrial buildings are now required to be sprinklered, the canopy or setback is only required in unsprinklered commercial and industrial buildings two or three storeys in height.

FIRE EXPOSURE OF EXIT FACILITIES

An exterior exit facility can be exposed unexpectedly to fire from exterior wall openings in a number of ways. Protection against this fire exposure can be provided for the openings by one of three methods of protection.

3.2.3.12.(4) The methods of protection accepted in the *NBCC* include:

- glass block
- wired glass
- closures

3.2.3.12.(1) & (3) Openings in close proximity to each other must be protected when they are in walls where the angle is 135° or less between:

- the exterior wall of a building and the exterior wall of an exit enclosure

- the exterior wall of one fire compartment and an exterior wall of another fire compartment containing an exit door

Although not explicitly stated, where an opening in an exterior exit enclosure is exposed, protection is required only if the other opening is in a different fire compartment.

This also applies for an exposed exterior exit door; protection is required only if the other exterior opening is located in a separate fire compartment.

3.2.3.12.(1) If an unprotected opening in the exterior wall of an exit enclosure (other than an exterior exit door) could be exposed to fire from an unprotected opening in the exterior wall of the same building, one of the openings must be protected by one of the methods of protection noted previously (glass block, wired glass or closures).

This applies only if any portion of the opening in the exit enclosure is within 3m horizontally and less than 10m above or 2m below any portion of the opening in the exterior wall of the building.

3.2.3.12.(3) If an exterior exit door is within 3m horizontally of an unprotected opening in the exterior wall of another fire compartment, the opening in the exterior wall must be protected by one of the methods of protection.



3.4.4.3.(1) Neither requirement for the preceding two cases applies to an exterior exit passageway that:

- has not less than 50% of the exterior sides open to the outdoors
- is served by exit stairs at each end of the passageway

An exterior unenclosed exit stair or ramp could constitute a third case of exposure.

3.2.3.12.(2) The exterior exit stair or ramp is considered exposed only if any portion of it is within 3m horizontally and less than 10m above or 5m below any portion of an opening in the exterior wall of the same building.

Under these conditions, the opening must be protected with one of the methods of protection.

7.6 Examples of Spatial Separation Calculations

The following are examples of limiting distance calculations and the construction options available for designing structures in proximity to a property line.

EXAMPLE 7.1

Figure 7.11 (pg 253) shows a very simple building arrangement:

Building height: one storey

Occupancy: Group A, Div. 2 (restaurant)

Sprinkler Protection: none

Building Position: walls parallel to the lot lines.

Distance to lot line: South-3m, West-2m

Height of exposing building face: $H = 3\text{m}$

Length of sides: $L_1 = 15\text{m}$

$L_2 = 9\text{m}$

Area of unprotected openings:

South Side = 13.2m^2

West Side = 2.4m^2

Determine:

- whether the limiting distance is sufficient on the South and West sides
- the type of construction required for these two exterior walls

3.2.2.28. In applying Subsection 3.2.2 requirements, the construction of the walls can be unrated wood frame construction.

Determining Limiting Distance

South Side

The minimum limiting distance required on the South side is

determined using the following information:

Area of exposing building face:

$$A_{\text{ebf}} = L \times H = 15 \times 3 = 45\text{m}^2$$

Area of unprotected openings:

$$A_{\text{upo}} = 13.2\text{m}^2$$

Ratio of length to height of fire compartment:

$$L/H = 15:3 = 5:1$$

Actual percentage of unprotected openings:

$$A_{\text{upo}}/A_{\text{ebf}} = 13.2/45 \times 100 = 29.3\%$$

Solution:

TABLE 3.2.3.1.A. Given this percentage of unprotected openings, the *NBCC* requires a limiting distance, D_1 , of 3.9m (by interpolation). This exceeds the limiting distance, 3m, actually provided for this side of the building.

Since the distance to the lot line, S_1 , is only 3m, there are several options:

- reduce the amount of unprotected openings to 19% as required for a limiting distance of 3m
- use wired glass or glass blocks in the openings
- move the location of the building back 0.9m so that the actual distance from the lot line is 3.9m

By using wired glass or glass blocks in the windows, the area of permitted unprotected openings can be doubled to 38%, well above the value desired by the owner.



The option chosen will be dictated by:

- economics
- whether or not the owner wants to keep all the windows in the South wall
- whether or not the distance to the lot line on the North side must be maintained

West Side

The minimum limiting distance required on the West side is determined using the following information:

Area of exposing building face:

$$A_{\text{ebf}} = L \times H = 9 \times 3 = 27\text{m}^2$$

Area of unprotected openings:

$$A_{\text{upo}} = 2.4\text{m}^2$$

Ratio of length to height of fire compartment:

$$L/H = 9:3 = 3:1$$

Actual percentage of unprotected openings:

$$A_{\text{upo}}/A_{\text{ebf}} = 2.4/27 \times 100 = 8.9\%$$

Solution:

TABLE 3.2.3.1.A. Given this percentage of unprotected openings, the *NBCC* requires a limiting distance, D_2 , of 1.5m (by interpolation). This is less than the 2m limiting distance, actually provided for this side of the building.

The owner could increase the area of the windows on the West side to 12.6 % or 3.4m² and still be within the allowed limits for a 2m limiting distance.

Determining Exterior Wall Construction Requirements

South Wall

The option selected to meet the limiting distance requirements for the South wall, will determine the type of construction required for the wall.

Option S7.1A:

Limiting Distance – 3m

Window Type – ordinary

Maximum permitted area of unprotected openings – 19 percent

3.2.3.7.(2) Wall Construction Requirements:

- can be wood frame construction
- must have one-hour fire-resistance rating (FRR)
- must be clad with noncombustible cladding

Option S7.1B:

Limiting Distance – 3m

Window Type – wired glass or glass block

Maximum permitted area of unprotected openings – 38 percent

3.2.3.7.(2) Wall construction requirements are the same as Option S7.1A.

3.2.3.11. The doubling of the 19% permitted openings for a limiting distance of 3m does not affect the type of construction required.

FIGURE 7.11

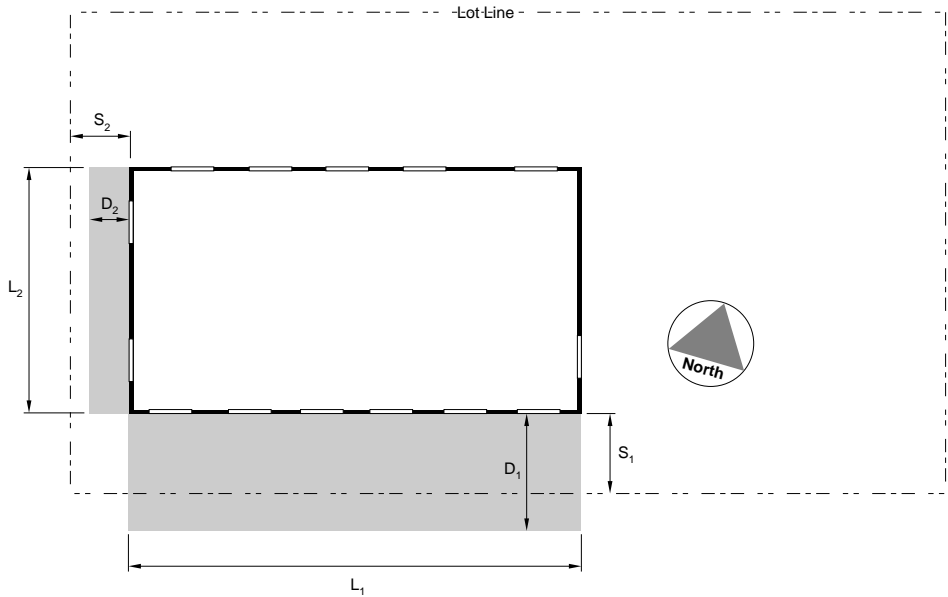
Limiting Distances — Examples 7.1 and 7.2**Option S7.1C:**

Limiting Distance — 3.9m
 Window Type — ordinary
 Maximum permitted area of unprotected openings — 29%

3.2.3.7.(3) Wall Construction Requirements:

- can be wood frame construction
- must have 45 minute FRR
- can be clad with wood siding

West Wall**Option W7.1A:**

Limiting Distance — 2m
 Window Type — ordinary
 Maximum permitted area of unprotected openings — 12.6%

3.2.3.7.(2) Wall Construction Requirements:

- can be wood frame construction
- must have one-hour FRR
- must be clad with noncombustible cladding

Option W7.1B:

To lower the one-hour fire-resistance rating and avoid the need for noncombustible cladding, the owner would have to relocate the building to make the limiting distance to the West wall at least 3.1m.

Limiting Distance — 3.1m

Window Type — ordinary

Maximum permitted area of unprotected openings — 26.6%

3.2.3.7.(2) Wall Construction Requirements:

- can be wood frame construction
- must have 45 minute FRR
- can be clad with wood siding

Avoiding Fire Rated Exterior Walls

If the owner wanted to avoid having to provide fire-resistance ratings for the walls, the limiting distances from these walls would have to be:

TABLE 3.2.3.1.A.

South Wall = 8m

West Wall = 7m

If firefighting facilities could not reach the building within 10 minutes, the minimum limiting distances would have to be doubled in order to avoid the fire-resistance ratings because the building is unsprinklered.

EXAMPLE 7.2

Same building as example 7.1 but building is sprinklered. The requirements and options available change significantly for a sprinklered building.

Determining Limiting Distance

South Side

The minimum limiting distance required on the South side is determined using the following information:

Area of exposing building face:

$$A_{\text{ebf}} = L \times H = 15 \times 3 = 45\text{m}^2$$

Area of unprotected openings:

$$A_{\text{upo}} = 13.2\text{m}^2$$

Ratio of length to height of fire compartment: Not applicable

Actual percentage of unprotected openings:

$$A_{\text{upo}}/A_{\text{ebf}} = 13.2/45 \times 100 = 29.3\%$$

Solution:

TABLE 3.2.3.1.C. Given this percentage of unprotected openings, the *NBCC* requires a limiting distance, D_1 , of 2.6m (by interpolation). This is less than the 3m limiting distance actually provided for this side of the building.

The amount of unprotected openings permitted for the 3m limiting distance is actually 38%. The area of the openings could be increased to this amount without affecting limiting distance or wall construction.

West Side

The minimum limiting distance required on the West side is determined using the following information:

Area of exposing building face:

$$A_{\text{ebf}} = L \times H = 9 \times 3 = 27\text{m}^2$$

Area of unprotected openings:

$$A_{\text{upo}} = 2.4\text{m}^2$$

Ratio of length to height of fire compartment: Not applicable

Actual percentage of unprotected openings:

$$A_{\text{upo}}/A_{\text{ebf}} = 2.4/27 \times 100 = 8.9\%$$

Solution:

TABLE 3.2.3.1.C. Given this percentage of unprotected openings, the *NBCC* requires a limiting distance, D_2 , of 0.7m (by interpolation). This is less than the 2m limiting distance actually provided for this side of the building.

3.2.3.5. The *NBCC* requires that when the limiting distance is less than 1.2m, any openings in the wall must be protected by closures other than wired glass or glass block. Consequently if the building is moved to within 0.7m of the property line, protective measures must be provided for the openings.

Determining Exterior Wall Construction Requirements

South Side

Unlike the unsprinklered case, where the increased allowance in unprotected openings due to the use of wired glass or glass block did not affect the minimum construction requirements, the increased allowance in openings due to sprinklering of the building is used to determine minimum construction requirements.

Option S7.2A:

Limiting Distance – 3.0m
 Window Type – ordinary
 Maximum permitted area of unprotected openings – 38%

3.2.3.7.(2) Wall Construction Requirements:

- can be wood frame construction
- must have 45 minute FRR
- can be clad with wood siding

West Side

Option W7.2A:

Limiting Distance – 2m
 Window Type – ordinary
 Maximum permitted area of unprotected openings – 25.2 %

3.2.3.7.(3) Wall Construction Requirements:

- can be wood frame construction
- must have 45 minute FRR
- can be clad with wood siding

If the building is moved closer to the lot line, the exterior wall construction will be affected.

Option W7.2B:

Limiting Distance – 0.7m
 Window Type – Protected by closures other than wired glass or glass block
 Maximum permitted area of unprotected openings – 0%

3.2.3.7.(1) Wall Construction Requirements:

- noncombustible construction
- one-hour fire-resistance rating
- clad with noncombustible cladding

Option W7.2C:

Limiting Distance – 1.2m
 Window Type – ordinary
 Maximum permitted area of unprotected openings – 15.2%

3.2.3.7.(3) Wall Construction Requirements:

- can be wood frame construction
- must be one-hour FRR
- must be clad with noncombustible cladding



EXAMPLE 7.3

Figure 7.12 shows a more complex building arrangement. The lot line runs at an angle and comes very close to the North-West corner. The building also features a recessed wall on the West side.

Building height: one storey

Occupancy: Group A, Div. 2 (restaurant)

Sprinkler Protection – none

Building Position: walls not parallel to the lot lines, with recessed sections

Distance to lot line: North-2m

West: • 1m (At the North-West corner)
• 6.7m (At wall section L_4)

Height of the exposing building face:

$H = 3\text{m}$

Length of sides:

$L_1 = 12.5\text{m}$

$L_2 + L_3 + L_4 = 10\text{m}$

Area of unprotected openings:

North Side = 8m^2

West Side = 8.5m^2
(including the door)

Determine:

- whether the limiting distance is sufficient on the North and West sides
- the type of construction required for these two exterior walls

3.2.2.28. As for Example 7.1, the construction of the walls can be unrated wood frame construction.

Determining Limiting Distance

North Side

The minimum limiting distance required on the North side is determined using the following information:

Area of exposing building face:

$$A_{\text{ebf}} = L \times H = 12.5 \times 3 = 37.5\text{m}^2$$

Area of unprotected openings:

$$A_{\text{upo}} = 8\text{m}^2$$

Ratio of length to height of fire compartment:

$$L/H = 12.5:3 = 4.2:1$$

Actual percentage of unprotected openings:

$$A_{\text{upo}}/A_{\text{ebf}} = 8/37.5 \times 100 = 21\%$$

Solution:

TABLE 3.2.3.1.A. Given this percentage of unprotected openings, the *NBCC* requires a limiting distance, D_1 , of 3.1m (by interpolation).

However, the distance to the lot line must be measured from the point where it is closest to the exposing building face, S_1 , which is 2m. For this limiting distance of 2m, the percentage of unprotected openings permitted in the North wall is only 11%.

Since the distance to the lot line, S_1 , is only 2m, additional protection must be provided. There are several options:

- reduce the amount of unprotected openings to 11% as required for a limiting distance of 2m

FIGURE 7.12

Limiting distances — Examples 7.3 and 7.4

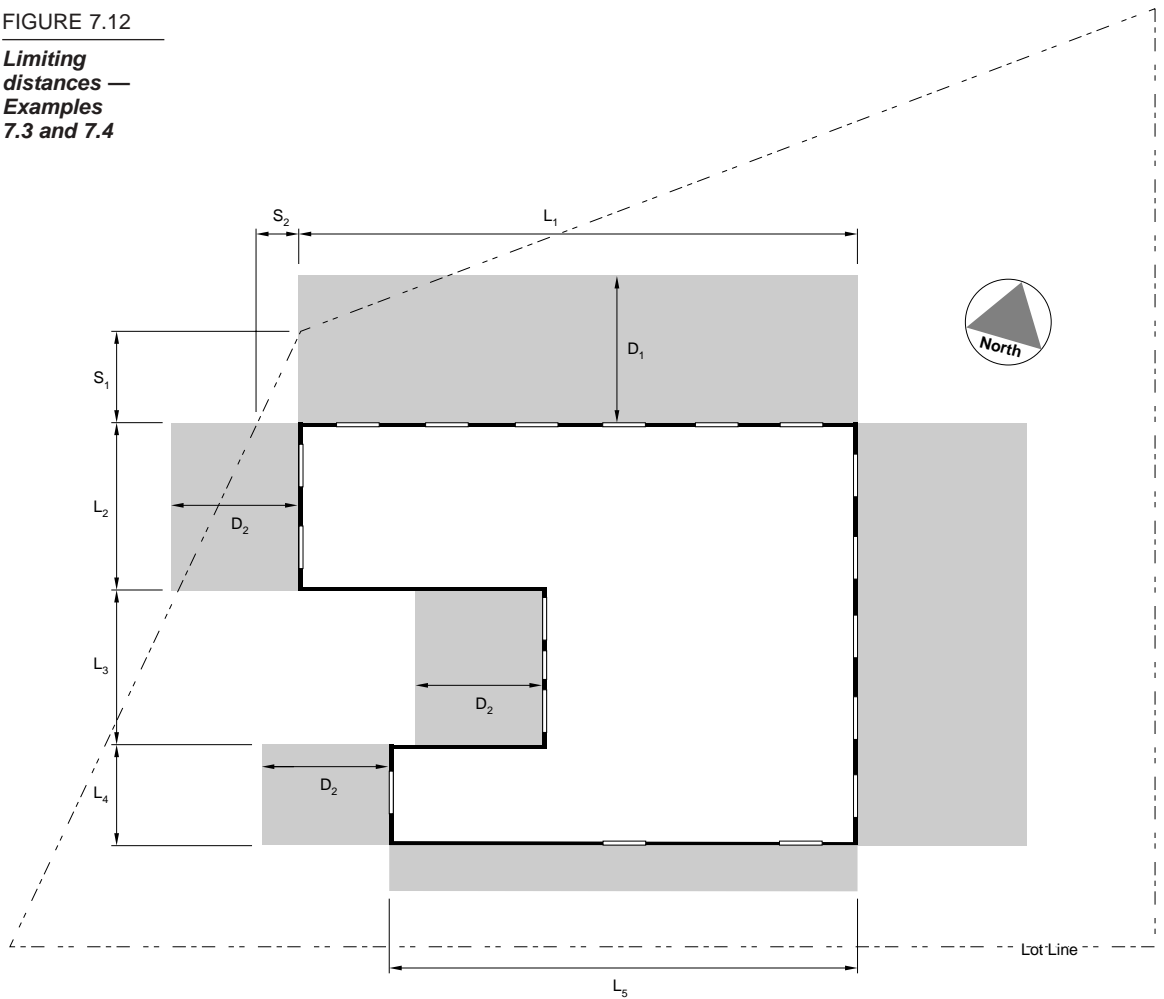

- use wired glass or glass blocks in the openings to double the amount of permitted unprotected openings to 22 percent, (just above the value desired)
- move the location of the building back 1.1m so that the limiting distance is 3.1m which allows the 21% desired unprotected openings

West Side

The minimum limiting distance required on the West side is determined using the following information:

Area of exposing building face:

$$A_{ebf} = (L_2 + L_3 + L_4) \times H = 10 \times 3 = 30m^2$$

Area of unprotected openings:

$$A_{upo} = 8.5m^2$$



Ratio of length to height of fire compartment:

$$L/H = 10:3 = 3.3:1$$

Actual percentage of unprotected openings:

$$A_{\text{upo}}/A_{\text{ebf}} = 8.5/30 \times 100 = 28.3\%$$

Solution:

TABLE 3.2.3.1.A. Given this percentage of unprotected openings, the *NBCC* requires a limiting distance, D_2 , of 3.3m (by interpolation).

The distance to the lot line must be measured from the point where it is nearest to any portion of the exposing building face, S_2 , which is 1m. On this basis, the entire exposing building face can have no unprotected openings because any opening within 1.2m of a lot line must be protected by closures, other than glass blocks or wired glass.

Since the distance to the lot line, S_2 , is only 1m, additional protection must be provided. There are several options:

- reduce the amount of actual unprotected openings to 0, as required for a limiting distance of 1m
- remove the windows from section L_2 of the wall
- move the location of the building back 2.3m so that limiting distance at the North-West corner is 3.3m which allows the 28.3% desired unprotected openings

Determining Exterior Wall Construction Requirements

North Wall

Option N7.3A:

Limiting Distance – 2m

Window Type – ordinary

Maximum permitted area of unprotected openings – 11%

3.2.3.7.(2) Wall Construction Requirements:

- can be wood frame construction
- must have one-hour FRR
- must be clad with noncombustible cladding

Option N7.3B:

Limiting Distance – 2m

Window Type – wired glass or glass block

Maximum permitted area of unprotected openings – 22%

3.2.3.11. Wall construction requirements are the same as option N7.3A. The doubling of the 11% permitted openings because they are protected by wired glass or glass block does not affect the type of construction.

Option N7.3C:

Limiting Distance – 3.1m

Window Type – ordinary

Maximum permitted area of unprotected openings – 21%

FIGURE 7.13

Limiting Distances — Example 7.3 Option W7.3B

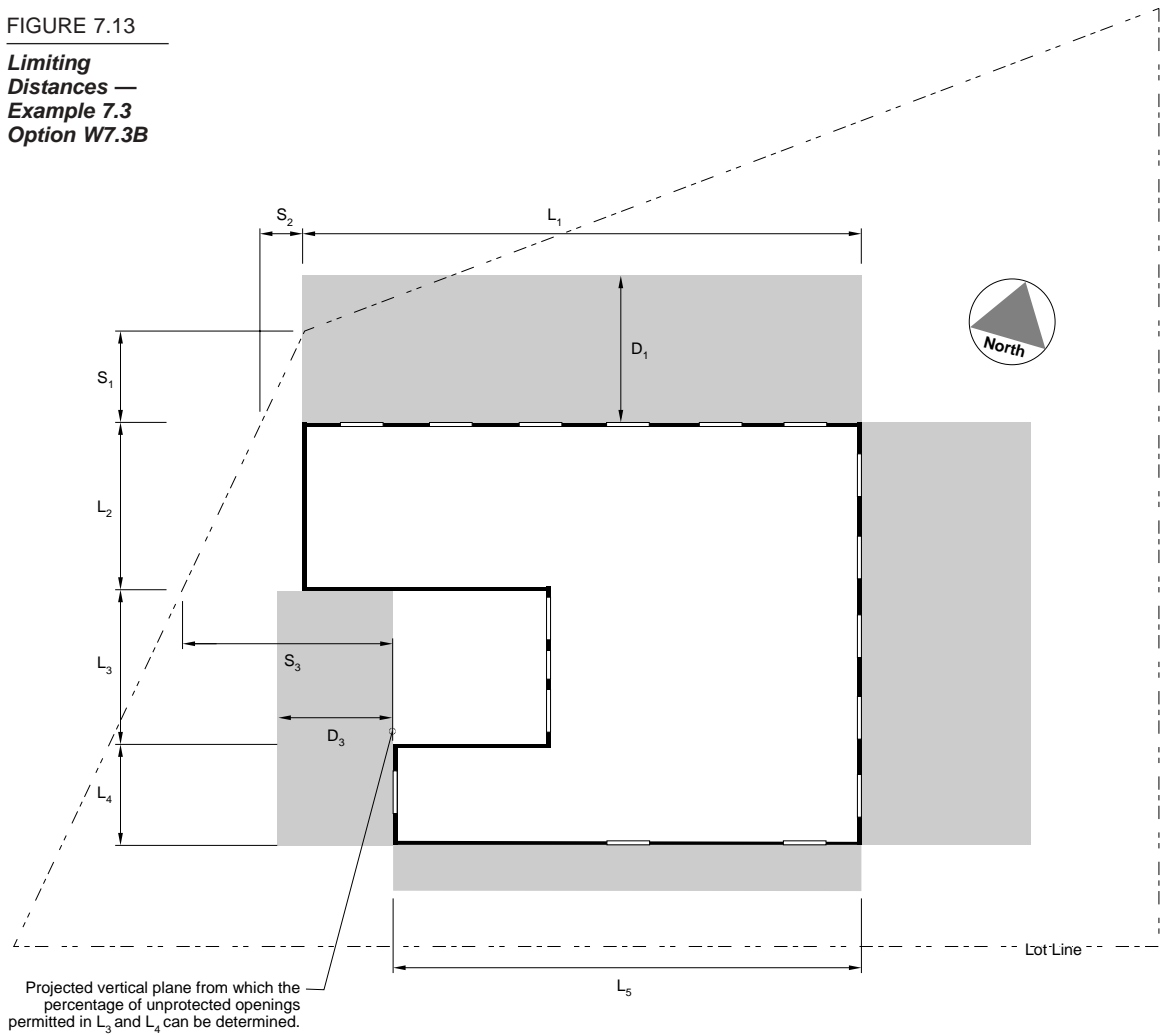

3.2.3.7.(3) Wall Construction Requirements:

- can be wood frame construction
- must have one-hour FRR
- must be clad with noncombustible cladding

West Wall

Option W7.3A:

Limiting Distance – 1m

Window Type – Must have closures other than wired glass or glass block

Maximum permitted area of unprotected openings – 0%

3.2.3.7.(2) Wall Construction Requirements:

- noncombustible construction
- one-hour FRR
- clad with noncombustible cladding

The limiting distance to the section closest to the lot line governs the construction type required. This construction type will apply to all wall sections, including those recessed further away from the lot line. Consequently, all three wall sections of the west wall must be of the same construction type and fire-resistance rating.

Option W7.3B:

3.2.3.1.(4) The *NBCC* permits the amount of unprotected openings to be calculated on the basis of a limiting distance measured from a vertical plane located so that there are no unprotected openings between the plane and the line to which the limiting distance is measured.

With the openings removed from wall section L_2 , the minimum limiting distance required for that wall section on the West side would then be determined using the following information:

Area of exposing building face:

$$A_{\text{ebf}} = (L_2 + L_3 + L_4) \times H = 10 \times 3 = 30\text{m}^2$$

Area of unprotected openings:

$$A_{\text{upo}} = 5.4\text{m}^2$$

Ratio of length to height of fire compartment:

$$L/H = 10:3 = 3.3:1$$

Actual percentage of unprotected openings:

$$A_{\text{upo}}/A_{\text{ebf}} = 5.4/30 \times 100 = 18\%$$

Solution:

TABLE 3.2.3.1.A. Given this percentage of unprotected openings, the *NBCC* requires a limiting distance, D_3 , of 2.6m (by interpolation).

This is less than the 5.3m distance (S_3) provided. Consequently, the unprotected openings in sections L_3 and L_4 can remain. (Figure 7.13)

The maximum percent of unprotected openings is expressed as a percentage of the area of the entire exposing building face. The total area of unprotected openings allowed can be placed in the smaller wall sections which are set back.

However, the construction requirements of Option W7.3A would still apply to all the wall sections even though the unprotected openings were removed from the section closest to the lot line.

Option W7.3C:

The building is moved back 2.3m. We now have:

Limiting Distance – 3.3m

Window Type – ordinary

Maximum permitted area of unprotected openings – 28.3%

3.2.3.7.(3) Wall Construction Requirements:

- can be wood frame construction
- must have 45 minute FRR
- can be clad with wood siding

If, as described in Options N7.3C and W7.3C, the building is moved 2.3m back from the West lot line and 1.1m further from the North boundary, the original minimum limiting distances required are met and the original design could stand.

Figure 7.14. shows the effect of such a relocation.

FIGURE 7.14
Limiting distances — Example 7.3 Option W7.3C and N7.3C

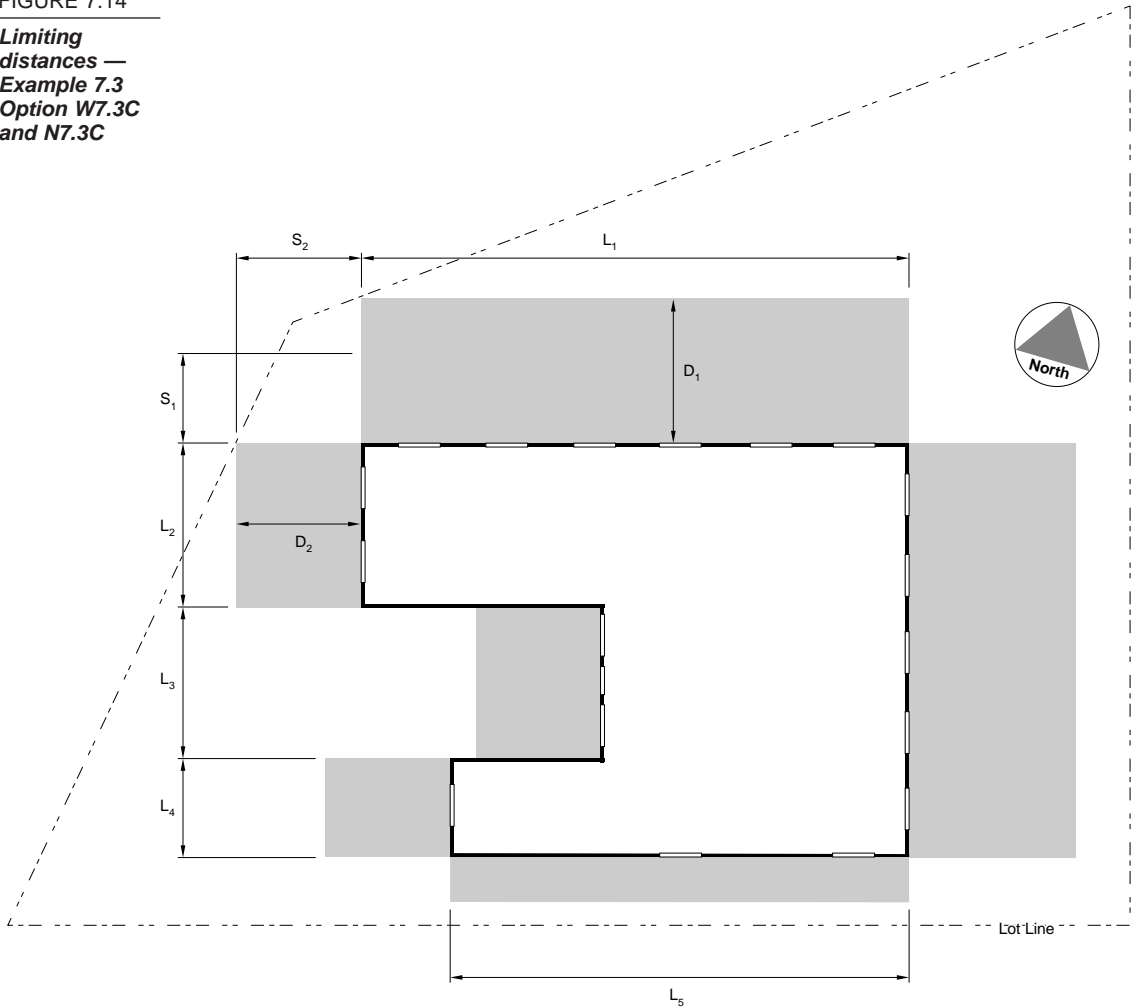

EXAMPLE 7.4

Same building as example 7.3 but building is sprinklered. The requirements change significantly for a sprinklered building.

Determining Limiting Distance

North Side

The minimum limiting distance required on the North side is

determined using the following information:

Area of exposing building face:

$$A_{ebf} = L \times H = 12.5 \times 3 = 37.5\text{m}^2$$

Area of unprotected openings:

$$A_{upo} = 8\text{m}^2$$

Ratio of length to height of fire compartment: not applicable



Actual percentage of unprotected openings:

$$A_{\text{upo}}/A_{\text{ebf}} = 8/37.5 \times 100 = 21\%$$

Solution:

TABLE 3.2.3.1.C. Given this percentage of unprotected openings, the *NBCC* requires a limiting distance, D_1 , of 1.9m (by interpolation). This is less than the 2m actual distance to the lot line at the worst location, the North-West corner.

West Side

The minimum limiting distance required on the West side is determined using the following information:

Area of exposing building face:

$$A_{\text{ebf}} = (L_2 + L_3 + L_4) \times H = 10 \times 3 = 30\text{m}^2$$

Area of unprotected openings:

$$A_{\text{upo}} = 8.5\text{m}^2$$

Ratio of length to height of fire compartment: not applicable

Actual percentage of unprotected openings:

$$A_{\text{upo}}/A_{\text{ebf}} = 8.5/30 \times 100 = 28.3\%$$

Solution:

TABLE 3.2.3.1.C. Given this percentage of unprotected openings, the *NBCC* requires a limiting distance, D_1 , of 2.2m (by interpolation).

Like the unsprinklered case, the distance to the lot line must be measured from the point where it is nearest to any portion of the exposing building face, S_2 , which is 1m. This building face can have no

unprotected openings because any opening within 1.2m of a lot line must be protected by closures, other than glass blocks or wired glass.

Determining Exterior Wall Construction Requirements

North Wall

Option N7.4A

Limiting Distance – 2.0m

Window Type – ordinary

Maximum permitted area of unprotected openings – 21.5%

3.2.3.7.(3) Wall Construction Requirements:

- can be wood frame construction
- must have one-hour FRR
- must be clad with noncombustible cladding

3.2.3.11. The doubling of the percent of unprotected openings for wired glass or glass block use does not apply in sprinklered buildings.

The provision of sprinklers in this building allows the desired amount of unprotected openings without having to increase the limiting distance. No other options need be considered for this wall.

West Wall:

Option W7.4A:

Limiting Distance – 1m

Window Type – Must have closures other than wired glass or glass block

Maximum permitted area of unprotected openings —
0% (actual)
11.7% (for determining wall construction)

The 11.7% is determined by interpolation. Even with a limiting distance of less than 1.2m, sprinkler protection reduces the construction requirements.

3.2.3.7.(2) Wall Construction Requirements:

- can be wood frame construction
- must have one-hour FRR
- must be clad with noncombustible cladding

The limiting distance is less than 1.2m and therefore no actual unprotected openings are allowed. Construction requirements however are determined based on the percentage of openings that would be permitted. The use of sprinklers results in the percent of permitted unprotected openings exceeding 10 percent. As a consequence the minimum construction requirements change.

Option W7.4B:

If the unprotected openings are removed from L_2 , the limiting distance becomes 2.6m, D_3 .

Limiting Distance — 2.6m
Window Type — Ordinary
Maximum permitted area of unprotected openings —
36.4% (actual)
11.7% (for determining wall construction)

3.2.3.7.(2) Wall Construction Requirements:

- can be wood frame construction
- must be one-hour FRR
- must be clad with noncombustible cladding

3.2.3.1.(4) The maximum amount of unprotected openings permitted, 36.4%, is calculated on the basis of a limiting distance measured from the vertical plane located so that there are no unprotected openings between the plane and the line to which the limiting distance is measured.

The construction requirements of Option W7.4A would still apply to all the wall sections. The construction is based on the smallest limiting distance and does not change based on the location of the openings.

Option W7.4C:

To retain the original design, the sprinklered building would only need to be located 2.2m from the West lot line, instead of the 3.3m for the unsprinklered case, and no further away from the North boundary.

Limiting Distance — 2.2m

Window Type — ordinary

Maximum permitted area of unprotected openings — 30%

3.2.3.7.(3) Wall Construction Requirements:

- can be wood frame construction
- must have 45 minute FRR
- can be clad with wood siding





Chapter Summary

The potential for fire spread between buildings increases significantly with proximity and the number of openings in exterior walls from which thermal radiation emanates.

Adjacent properties can be protected if sufficient distances between buildings are maintained or the number and size of openings through which radiation is emitted is limited.

The *NBCC* details calculation procedures and tables which establish distances and percentages of unprotected openings.

The role of automatic sprinklers in reducing fire spread from building to building is also reflected. New spatial separation tables for sprinklered buildings significantly reduce construction, limiting distance and unprotected opening requirements compared to those for unsprinklered buildings.

8

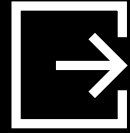

Fire Safety within Floor Areas

8.1	General Information	267
8.2	Occupant Load	269
8.3	Fire Alarm and Detection Systems	273
	Alarm Systems	273
	Fire and Smoke Detection Systems	276
	Signal to Fire Departments	279
8.4	Means of Egress	281
	Suites	281
	Access to Exits	282
	Exits	288
8.5	Safety within Floor Areas of Specific Occupancies	293
	Assembly Occupancies	293
	Residential Occupancies	293
	Care Facilities	294
	Repair and Storage Garages	295
8.6	Service Spaces	297
	Chapter Summary	299





EXIT

8.1 General Information

Previous chapters have explained that the spread of fire can be controlled by:

- limiting the combustibility and flammability of building components
- providing automatic sprinkler protection
- providing physical barriers to contain the fire

However, the immediate safety of building occupants depends primarily on:

1. how quickly they are alerted to a hazardous situation
2. the means of escape available
3. the degree to which those means of escape offer protection from life-threatening conditions

The Manage Exposed branch of the NFPA Fire Safety Concepts Tree offers two alternatives: Safeguard Exposed and Limit Amount Exposed (exposed being people).

Limiting the number of people that might be exposed to a fire is an administrative responsibility governed by the *National Fire Code of Canada (NFCC)*.

The Safeguard Exposed branch relies on means to:

- Defend Exposed in Place, or
- Move Exposed

The Defend Exposed in Place concept applies particularly to institutions such as prisons, hospitals and nursing homes where mobility is restricted. If the occupants cannot be easily moved away from the hazard,

special safeguards must be in place for them to safely remain in the vicinity.

The Move Exposed branch applies to situations where occupants are alert and mobile, and can easily be moved to a safe destination. All three steps in the Move Exposed branch, (Figure 3.1), must be followed to achieve its objective:

1. Cause Movement of Exposed
2. Provide Movement Means
3. Provide Safe Destination

In other words, occupants must be alerted to the danger, must have means of egress and must have a safe destination.

This chapter describes the principles behind *NBCC* requirements that provide for the safe movement of building occupants during a fire. Access for firefighting is an important part of fire safety within floors but is described separately in Chapter 9.

The role of the firefighter is important to the safety of the occupants in a fire situation. Firefighters can help occupants to evacuate efficiently. In addition, many building fire alarm systems help fire departments locate a fire quickly, thereby aiding firefighters' efforts to protect occupants.

As seen in Chapter 4, fire safety requirements for the overall building are based on the building's major occupancy. *NBCC* requirements for safety within floor areas, related to means of egress, are based on the specific

occupancy of the floor area, room or space being considered. For example, an office building classed as a Group D major occupancy may contain a small employee cafeteria. Fire safety requirements for a cafeteria are not the same as those for an office, and therefore will be applied separately.

Requirements for service spaces are also discussed. These areas are treated separately because they are usually unoccupied and inaccessible to the public or to building occupants.

8.2 Occupant Load

In planning exit facilities, and in determining the need for a fire alarm system, the first consideration is: How many people need to be moved through the exit system?

A door can only allow a certain number of people to pass through in a given amount of time. If a large number of building occupants must funnel through one door, a queue, or lineup, will result.

Studies show that under the psychological stress imposed by an emergency, a queue will make crowd control more difficult and cause people to panic. This can become a dangerous situation.

A sufficient number of appropriately sized exits must be provided to allow complete evacuation in a reasonable amount of time. In addition, the choice of alarm system to provide detection and early warning of a fire should take into consideration the nature of the occupants, (for example, mobility, age, number, and location in the building).

In unsprinklered buildings, the need for a fire alarm system and the number and size of exits required to safely evacuate all occupants in a space is based on the number of people using the facility. This number is called the occupant load.

Occupant load is defined as: “the number of persons for which a building or part thereof is designed.”

Occupant loads are used strictly for determining fire safety require-

ments and should not be confused with dead loads or live loads used in design of structural members.

3.1.16.1. The *NBCC* assigns values, based on observations, to calculate the number of people that can reasonably be expected to occupy a space for a specified purpose. The values in *NBCC* Table 3.1.16.1. give the area in square metres per person for common uses. There are two exceptions to this:

- for rooms or space with fixed seats, the number of seats is used to determine the occupant load
- for dwelling units, the occupant load is based on two persons per sleeping room

To calculate the number of people, or occupant load, a designer must first determine the total floor area that can be utilized. The following areas are not included when determining occupant load:

- interior walls and partitions
- vertical shafts
- washrooms
- service rooms
- exits

The occupants of the floor area are those using the washrooms, and so to include the washrooms would mean counting them twice. Service rooms such as small electrical rooms are excluded as they are usually unoccupied and when occupied, it is often by a person or persons already calculated in the occupant load for the general floor area.



Once the area of the room or space is determined, it is then divided by the value in *NBCC* Table 3.1.16.1. for the occupancy type to obtain the occupant load. This occupant load is then used to determine the requirements for an alarm system, and the number and size of exits. Alarm systems can also be required for reasons other than occupant load. These are detailed in section 8.3

The values in Table 3.1.16.1. should be used only for determining exit and alarm requirements. They should not be used to determine room sizes or area required to accommodate a specific number of people. These numbers are intended to determine the maximum possible number of people that the exits could be required to serve. These numbers do not correspond with the area that should be designed for occupant use. Other architectural methods exist for determining areas required for occupants.

The improper application of unit area per person can lead to unsafe conditions, particularly in rehabilitation projects where a space is converted to a new occupancy with a much lower area per person. The new value should be used only to assess exit capacity.

3.1.16.1.(1)(c) The *NBCC* does give some discretion to the authority to approve different occupant load values where the owner can show that fewer persons will occupy the area. For example, a supper club might be designed with a large dance area and widely spaced tables. Since those using the dance area are presumably those occupying the tables, the dance area could be excluded from the area calculation for determining occupant load. The authority having jurisdiction could then be satisfied that the occupant load is less than otherwise calculated using the assigned values.

FIGURE 8.1

Number and characteristics of occupants determine design standards



NBCC values are only provided for common uses. For special designs or occupancies not included in Table 3.1.16.1. of the *NBCC*, an occupant load can usually be determined jointly between the designer and the local authority.

3.1.16.1.(4). Where a room serves more than one purpose, the occupant load must be determined based on the use involving the highest density of occupants. An assembly floor area, for example, may be used at different times for :

- non-fixed seating
- standing space
- dining or other purposes

For such multipurpose use, the calculation is based on the smallest number of square metres per person, or highest density, in the Table for any of the multi-purpose uses. In this case, the value for standing space would have to be used for determining occupant load.

8.3 Fire Alarm and Detection Systems

The Move Exposed objective of the NFPA Fire Safety Concepts Tree relies on the successful implementation of several steps. The first step is Cause Movement of Exposed, which means that the building occupants are alerted to the existence of a fire. The main method of achieving this is by means of a fire alarm system.

ALARM SYSTEMS

The provision of a fire alarm system depends primarily on:

- the major occupancy classification
- occupant load
- building size
- whether the building is sprinklered

3.2.4.1. Generally, the *NBCC* requires a fire alarm system in all sprinklered buildings and in all buildings containing over three storeys, including storeys below grade. The storeys below grade are included because fires can develop there undetected, and may have fuel and occupant loads comparable to other storeys.

In residential occupancies, an alarm system is generally required in buildings having sleeping accommodation of more than 10 persons, or when located in a building containing more than three storeys.

3.2.4.1.(3) An alarm system is not required in residential buildings, including hotels and motels, if:

- each of the dwelling units or suites is served by an exterior

exit facility leading directly to ground level

- it is not more than three storeys in height
- for an apartment building, not more than four dwelling units share the same means of egress

Individual egress routes will reduce exit time. Exterior exit facilities provide smoke-free egress routes and also allow immediate firefighting access.

3.2.4.1.(2) Other conditions where fire alarm systems are required include unsprinklered buildings which contain:

- a contained use area
- an impeded egress zone
- a total occupant load more than 300, other than in open air seating areas
- an occupant load more than 150 above or below the first storey, other than in open air seating areas
- an occupant load more than 300 below an open air seating area
- a school, college, or child care facility, including a day care facility, with an occupant load more than 40
- a licensed beverage establishment or a restaurant, with an occupant load more than 150
- a medium hazard industrial occupancy or a low hazard industrial occupancy with an occupant load more than 75 above or below the first storey
- a high hazard industrial occupancy with an occupant load more than 25



Types of Fire Alarms

3.2.4.4. The *NBCC* specifies two types of fire alarm systems:

- the single-stage system, in which manually activated signalling boxes (pull stations) or other devices cause a general alarm to sound throughout the building
- the two-stage system, in which the activating device first sounds an alert signal to warn those on duty that an emergency exists before the general alarm is given

The two-stage alarm allows supervisory staff to verify the nature of the emergency before initiating evacuation. If the supervisory personnel do not respond to the alert signal within five minutes, the general alarm is automatically activated. Manual pull stations must be equipped to allow for a general alarm signal to be initiated immediately, if so desired by supervisory personnel.

3.2.4.3. In Group B, care or detention occupancies, where people are under restraint, or are otherwise restricted by age or infirmity, a two-stage alarm is required. This avoids initiating evacuation for what could be a false alarm.

The first stage or alert ensures that staff has an opportunity to investigate the emergency before the building is evacuated at the sound of the general alarm. However, a single-stage system is permitted in children's custodial homes, convalescent homes and orphanages, provided the building

is not more than three storeys in height.

The fire alarm system in Group F, Division 1, high-hazard industrial occupancies must be a single-stage system because of the need for prompt alarm and evacuation. Two-stage systems are not permitted in this type of occupancy, since a fire could develop with such speed that any delay in sounding a general alarm might have life-threatening implications.

In all other cases, where a fire alarm system is required, it can be either a single stage or two stage system.

Continuity of Fire Alarm Systems

3.2.4.2. As a general principle, if a fire alarm system is required in any portion of a building, the system must serve the entire building. This can even apply to buildings that are considered separate buildings by the *NBCC* because they are divided by a firewall. The alarm must be provided on both sides of the firewall only if there are large openings through it such as windows, doors or HVAC ducts.

In multiple occupancy buildings, requirements for a fire alarm system serving each major occupancy may differ. Even if only one major occupancy in the building requires an alarm system, the system must be designed to serve the entire building. The sounding of the alarm in one occupancy must activate the alarm throughout the building.

This will alert all the occupants of the building to the danger.

3.2.4.2.(4) The *NBCC* does make an exception to the continuity of fire alarm systems for buildings which are:

- up to three storeys in height
- divided by vertical one-hour fire separations through which there is no access from one portion of the building to another

3.2.4.1. This includes buildings such as row housing units and industrial plazas or malls.

This exception is due to each suite having its own exits independent of others and travel distances being short. In such cases, each portion is permitted to be provided with separate and independent fire alarm systems. This exception does not apply to buildings required to be sprinklered.

Installation Requirements

3.2.4.5. Fire alarm systems must be installed and tested in accordance with

- *CAN/ULC-S524 Standard for the Installation of Fire Alarm Systems*
- *CAN/ULC-S537 Standard for the Verification of Fire Alarm Systems*

Proper installation and ongoing maintenance of fire alarm systems are both vital. This ensures that the system functions properly and will promptly alert building occupants to a fire.

Annunciator Panels

3.2.4.8.(1) In general, all buildings which are required to be sprinklered or required to have a fire alarm system must be provided with an annunciator panel to advise firefighters of the location of the fire. The panel must be located in close proximity to a building entrance that faces a street or access route. If there is more than one such entrance, a panel is required at only one of the entrances, preferably the entrance where fire department personnel are expected to enter.

3.2.4.8.(5) Annunciator panels are not required for certain smaller buildings required to have a fire alarm system when:

- the aggregate area for all storeys (including those below grade) does not exceed 2000m²
- the building is not more than three storeys in building height
- the building is not sprinklered

In such cases, the requirement for an annunciator panel is waived because, given the size of the building, the location of the fire should be readily obvious.

3.2.4.8.(4) When an annunciator panel is not installed in a building required to have a fire alarm system, the alarm system must be connected to a signal device which will give a visual and audible trouble signal to alert the occupants to a problem with the system. This signal device must be located at the main entrance to the building.



3.2.4.8.(2) Fire alarm systems in larger buildings must be zoned. The annunciator panel must indicate the location of the alarm activation for each separate floor area or zone. No zone can exceed 2000m² in area.

3.2.4.8.(6) This area limit does not apply to interior undivided open space used for an arena, rink, or swimming pool. In such cases, the entire open space can be one zone, while the remaining portions of the building are still zoned for every 2000m² of area.

FIRE AND SMOKE DETECTION SYSTEMS

The effectiveness of a fire alarm system depends on how quickly it is activated after the outbreak of a fire. If activation of the alarm system relies on manual pull stations, a significant amount of time could elapse before the alarm is given to the fire department because:

- the fire could be burning undetected in an unoccupied area, or
- occupants could fail to pull the alarm in their haste to evacuate the premises

Manual Pull Stations

3.2.4.17.(1) Manual pull stations are required in most buildings in which a fire alarm system is installed. The stations must be installed:

- near every required exit
- near the principal entrance to the building on any storey located at ground level

3.2.4.17.(3) In a building containing a hotel or motel or only dwelling units, pull stations are not required at exterior egress doorways from a suite or dwelling unit provided:

- the building is not more than three storeys in height
- the building is sprinklered
- each suite or dwelling unit is served by an exterior exit facility leading directly to ground level
- the egress doorway does not lead to an interior shared means of egress

3.2.4.17.(4) Manual pull stations are required near any doorway leading from a shared interior corridor to the exterior in the above cases.

Automatic Detection Requirements

Buildings requiring a fire alarm system also require some means of automatic fire detection, including:

- heat detectors of either fixed temperature or rate of rise
- automatic sprinklers
- smoke detectors

The value of fire detectors in saving lives is beyond doubt; precious time is gained through early warning. They are particularly useful in:

- residential occupancies where occupants may be sleeping
- in hospitals and nursing homes to initiate preplanning response by staff
- in areas such as storage locker rooms and service rooms, where a fire may gain considerable intensity before it is detected

3.2.4.10.(2) In unsprinklered buildings where a fire alarm is required, fire detectors connected to the fire alarm system must be installed in specific areas. These areas are typically unoccupied and often contain potential ignition sources and include:

- storage and service rooms not within a dwelling unit
- janitor's rooms
- elevator and dumbwaiter shafts
- laundry rooms not within a dwelling unit

These fire detectors can be either smoke or heat detectors.

3.2.4.11. In buildings where large groups gather or where occupants may sleep, smoke detectors are also required in those vital areas such as:

- sleeping rooms and egress corridors from Group B
- all public corridors in Group C
- corridors in Group A Division 1 occupancies
- exit stair shafts
- rooms and corridors in a contained use area
- interconnected floor spaces next to draft stops provided around the floor openings

In these areas, a quick response is essential should a fire occur.

Many buildings have a mechanical ventilation system that recirculates air throughout the building through one or more central plenum chambers. These systems can distribute smoke from the origin of fire throughout the building.

Even a relatively small fire has potential to contaminate an entire building with smoke through an air circulation system. Smoke can be sufficiently dense or toxic, even when it is diluted, to impede evacuation particularly when it is discharged into a means of egress.

3.2.4.12. For this reason, duct-type smoke detectors are often installed in recirculating air handling systems where a fire alarm system is required for a building. Specifically, these detectors are required when the air handling system:

- serves more than one storey
- serves more than one suite in a storey
- serves more than one fire compartment in floor areas containing patient rooms in a hospital or nursing home

These smoke detectors initiate an alarm which activates dampers and fan controls to shut down the equipment which prevents the distribution of contaminated air throughout the building.

Automatic Detection Systems

Several types of fire and smoke detection devices are available. The heat detector is designed to sense abnormally high temperatures or a high rate of temperature rise. Its disadvantage is that it will not necessarily detect a smouldering fire. A smouldering fire can produce enough smoke to cause a hazard to life before sufficient heat builds up to activate the detector. On the positive side, heat detectors are reliable and need little maintenance.



Smoke detectors can detect the presence of fire at a much earlier stage than heat detectors. Smoke detectors are activated by products of combustion and will detect a smouldering fire.

There are two principal types of smoke detectors (Figure 8.2):

- photo-electric smoke detectors measure the amount of light obscuration caused by the presence of products of combustion
- ionization detectors react to a reduction in conductance caused by the presence of products of combustion

Both types require periodic maintenance.

Infrared and ultra-violet detectors respond to low-energy flames and are most appropriate in areas where flammable liquids are stored.

FIGURE 8.2

Smoke detectors

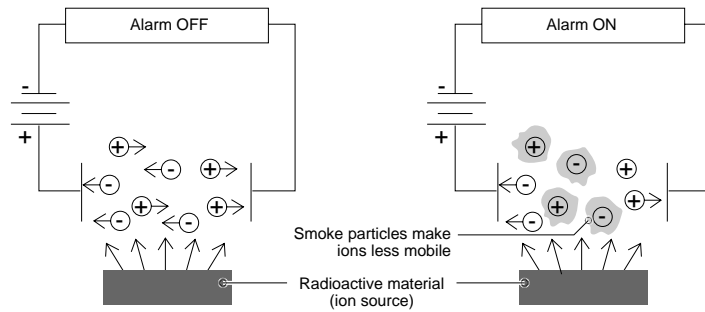

Photoelectric Detector

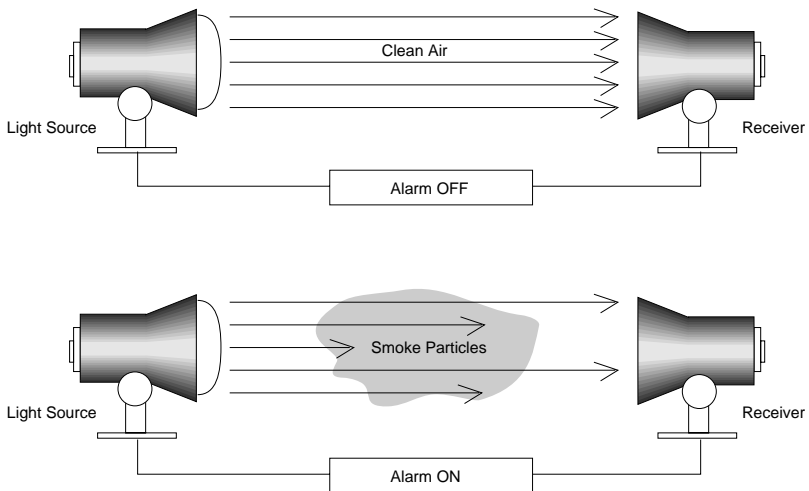

All of these heat, smoke and flame detectors are designed to provide a signal to the building fire alarm system. The type most suitable for a particular floor area depends on the physical characteristics of the hazard associated with the floor area.

3.2.4.21. The *NBCC* requires a smoke alarm in all dwelling units, and in any sleeping room outside a dwelling unit that is not in a care or detention occupancy required to have a fire alarm system. Thus every apartment and every bedroom in hotels, motels, dormitories and similar buildings must be equipped with a smoke alarm.

3.2.4.21.(2) In multi-storey dwelling units, at least one smoke alarm is required to be installed on each storey. These smoke alarms must be wired so that if any one activates, all the alarms will sound.

A smoke alarm differs from a smoke detector in that it is not connected to a fire alarm system, but is instead designed to act as a self-contained fire detector and alarm. It will warn occupants within a suite or dwelling unit of a fire in time to safely exit the building.

Smoke alarms are relatively inexpensive and reliable, provided they are tested and maintained regularly to remove dust and other airborne particles from cooking and smoking that become trapped in the detection chamber.

3.2.4.21.(8) The *NBCC* permits a manual disconnect device to be installed to allow disabling the smoke alarm temporarily. This permits silencing the alarm in the case of burnt toast without the permanent disconnection of these critical alarms.

3.2.4.15. Automatic sprinklers are considered to fulfill the requirement for fire detectors because they operate on the same principle as fixed temperature heat detectors.

High buildings are subject to additional requirements for fire alarm and detection systems, such as the provision of voice communication systems. These are discussed in Chapter 10, High Buildings.

SIGNAL TO FIRE DEPARTMENTS

The sooner a fire is detected and extinguished, the more lives can be saved and the less property damage incurred. If a fire is detected in its early stages, it can often be controlled by portable fire extinguishers. It is difficult, however, to predict the severity of a fire, and the fire department should always be called as soon as a fire is discovered.

3.2.4.7. This is one reason why the 1995 *NBCC* now requires that all automatic sprinkler systems be designed to transmit a signal to automatically notify the fire department that a waterflow detection device has been activated.



3.2.4.9.(2) All automatic sprinkler systems must be electrically supervised to ensure that any impairment or tampering with the system will be detected. Electrical supervision ensures that an electrical signal will be transmitted to the annunciator panel if any of the following occur:

- any valve controlling water supply is moved
- a pressure loss develops (water flow)
- the electrical supply to any automatic fire pump system fails
- the water supply becomes inadequate
- the temperature falls sufficiently to cause part of the water supply to freeze

3.2.4.7. Single stage fire alarm systems are not required to be designed to transmit a signal to notify the fire department except in a building of assembly occu-

pancy having an occupant load more than 300. When the alarm system does not send a signal to the fire department, a legible notice stating that the fire department be notified must be posted on the wall near each manual pull station.

Signals to the fire department may be transmitted by:

- proprietary control centres conforming to Chapter 9 of NFPA Standard 72D, *Installation, Maintenance and Use of Proprietary Protective Signalling Systems*
- a central station located off the premises, usually monitored by an independent agency

Proprietary control centres are monitoring stations located on the property which ensure constant supervision. The alarm signal may be transmitted to the fire department automatically or manually via a supervised circuit.

8.4 Means of Egress

Means of egress, including exits and access to exits, is a major factor affecting life safety.

An exit is that part of a means of egress which leads from the floor area it serves to the outside or other safe destination. In other words, it is the final, most protected link between any part of the building and a safe destination.

Theoretically, once occupants of a building enter an exit, they should be protected from the threat of fire until they reach safety. Access to exits are those facilities within a floor area which lead from a suite, or from any part within a suite, to the exit.

The *NBCC* requirements for means of egress are intended to satisfy steps two and three in the Move Exposed Branch of the NFPA Fire Safety Concepts Tree:

- Provide Movement Means
- Provide Safe Destination

SUITES

Before discussing access to exits, it is useful to explain what constitutes a suite, since a number of access to exit requirements depend on whether a floor area is occupied by a single tenant or several tenants.

A suite is a room or group of rooms occupied by a single tenant. The rooms within a suite have access to each other either directly by means of a common doorway, or indirectly by an interior corridor, by a vestibule or by other similar arrangement contained within the suite.

In the *NBCC*, it is irrelevant whether the suite is rented or owned. It is important that a suite be under the control of a single tenant. Thus, common laundry rooms or service rooms are not considered as suites.

Classrooms in a school, individual patient rooms, or units such as a maternity ward in a hospital are not considered suites either. They belong to a single owner, (the school board or the hospital administration), which normally has control over those spaces. On the other hand, areas individually rented or owned by different tenants in an apartment building, a hotel or an office building, are primarily under the control of those tenants, and one tenant normally has no control over another tenant's suite.

Should a fire occur in an unoccupied suite, occupants of neighbouring suites would not be aware of a fire until they could smell smoke or were otherwise alerted to the existence of a fire; by then, the fire could be well developed. This underlines the importance of installing fire detectors connected to an alarm system in each suite to alert all occupants of a fire, and separating suites to help contain a fire.

The *NBCC* refers to suites and rooms not located within a suite. This is intended to clarify that the requirement applies to:

- individual suites but not to each room within the suite
- common rooms, such as laundry or service rooms that are not under the control of a single tenant

FIGURE 8.3

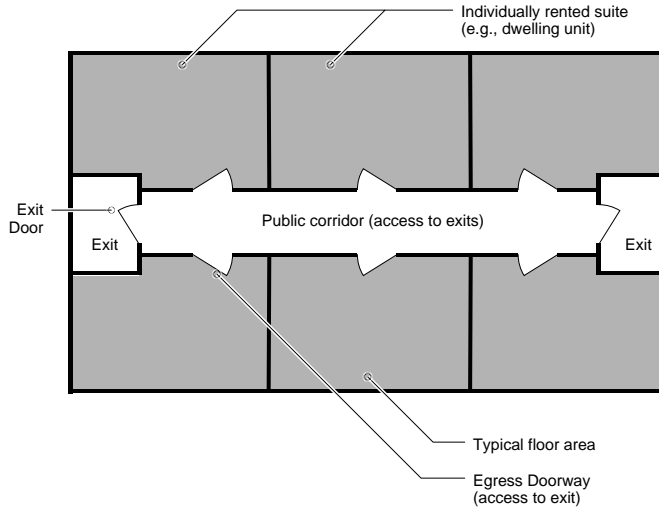
Typical access for floor areas**ACCESS TO EXITS**

The “access to exits” concept is often misunderstood. Access to exit refers to a path of travel from any point on a floor area to an exit serving the floor area. This includes:

- that part of an individual room or suite which leads to an exit
- a doorway that leads to a public corridor or other shared means of egress
- the path of travel from the suite doorway to the exit which can include corridors, public corridors and passageways (Figure 8.3)

The access to exit portion located within a room or a suite is not subject to specific requirements other than:

- it must provide an unobstructed path of travel to an egress doorway **3.3.1.22.(1)**

- the distance from any point in the room or suite to an egress doorway must not exceed specified limits depending on the occupancy **3.4.2.5.**

Specific requirements related to fire separations within occupancies and seating arrangements in assembly occupancies have an impact on access to exits because they affect the path of travel. Travel distance is measured along the path of travel from any point in a floor area to the nearest exit (Figure 8.5).

Limits on travel distances are obviously important because of the potential for an occupant to be exposed to unsafe conditions before reaching the safety of an exit.

Egress Doorways

3.3.1.3.(8) Generally, any floor area containing more than one suite requires only one egress doorway from each individual

suite. This single egress doorway from the suite must be:

- an exterior exit doorway leading to the outside
- a doorway leading to a public corridor that provides access in opposite directions to two separate exits
- a doorway leading to an exterior passageway that is open to the outdoors, and leads in opposite directions to two separate exits

3.3.1.5. Except for dwelling units, at least two egress doorways must be provided if a room or suite:

- is used for a high-hazard industrial occupancy and has an area more than 15m²
- is intended for an occupant load of more than 60 persons
- has an area or the travel distance from any point within the room or suite to an egress

FIGURE 8.4

Corridors and classroom doorways provide access to exit



doorway exceeding the values shown in Table 8.1 for an unsprinklered suite

- has an area which exceeds the value in Table 8.2, or the travel distance within the room or suite to an egress doorway is more than 25m for a sprinklered suite

To determine whether more than one egress doorway is required from a room or suite, the maximum travel distance is measured along the path of travel from any point within the room or suite to the nearest egress doorway. Unless only one exit is required for the floor area, it is assumed that the egress doorways

TABLE 8.1

Egress in floor area not sprinklered throughout

Occupancy of Room or Suite	Maximum Area of Room or Suite m ²	Maximum Distance to Egress Doorway m
Group A	150	15
Group C	100 ⁽¹⁾	15 ⁽¹⁾
Group D	200	25
Group E	150	15
Group F, Division 2	150	10
Group F, Division 3	200	15

Source: Table 3.3.1.5.A of the NBCC

1. See Article 3.3.4.4. for dwelling units

TABLE 8.2

Egress in floor area sprinklered throughout

Occupancy of Room or Suite	Maximum Area of Room or Suite m ²
Group A	200
Group B, Division 1	100
Group B, Division 2 sleeping rooms	100
other than sleeping rooms	200
Group C	150 ⁽¹⁾
Group D	300
Group E	200
Group F, Division 2	200
Group F, Division 3	300

Source: Table 3.3.1.5.B. of the NBCC

1. See Article 3.3.4.4. for dwelling units

will open into a corridor or passageway where it will be possible to travel in two different directions to separate exits.

3.3.1.6. Once the number of egress doorways required is determined, the maximum travel distances for exits are calculated. The maximum travel distances within the room or suite to the egress doorways must not exceed the limits set for maximum travel distance for exits.

3.3.1.5. When two or more egress doorways are required, the doorways must be located as far as practicable from each other. This is so that in the event of a

fire, if one becomes inaccessible, at least one of the others can still be used. Exact dimensions for minimum distances between doors are not provided since these will depend on the design of the suite; judgement must be exercised in each case.

3.4.2.4.(1) For an open floor area that serves a single tenant, the travel distance to an exit is measured from any point on the floor area to the nearest exit door (Figure 8.5). In a multi-tenant floor area, travel distance to an exit is typically measured for each tenant space from the most remote point in the room or suite through the corridor to an exit.

FIGURE 8.5
Undivided floor area

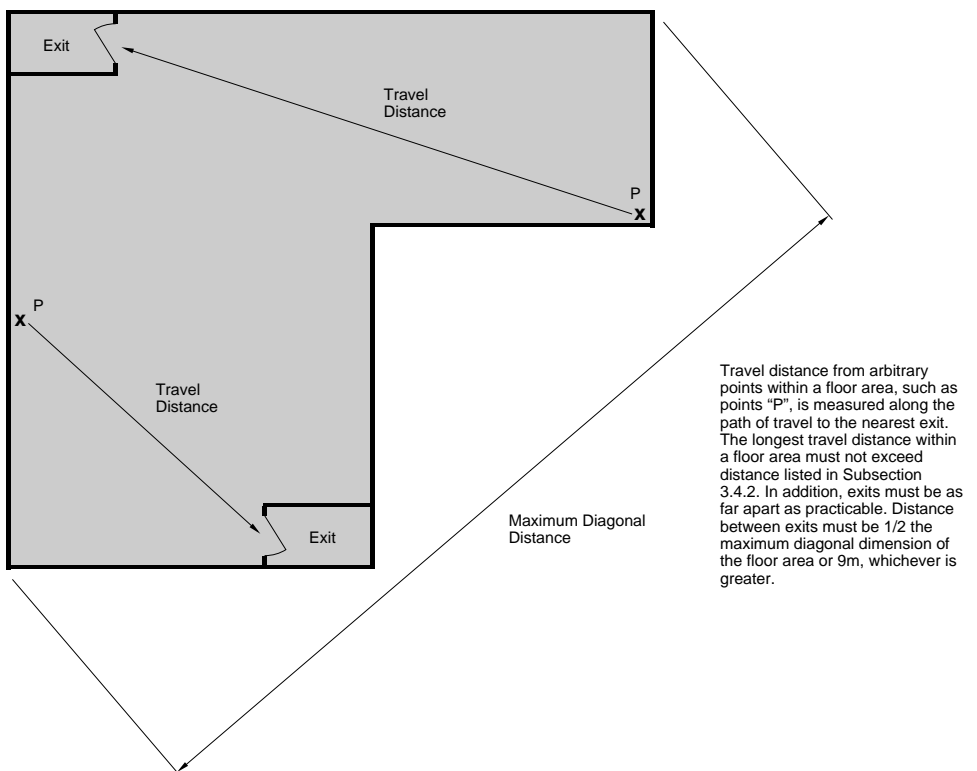

3.4.2.4.(2) Travel distance to the nearest exit can be measured from the egress door of a suite or a room not within a suite if it is separated from the remainder of the floor area by: (Figure 8.6)

- fire separations with a fire-resistance rating of not less than 45 minutes, or
- by unrated fire separations if the floor area is sprinklered

3.4.2.4.(2) Egress doors must open onto

- an exterior passageway
- a public corridor
- a corridor used by the public

3.3.1.4. The requirement for fire separations between the corridors and the remainder of the floor area is dependent upon:

- the occupancy
- whether the floor area is sprinklered
- the width and, in some cases, the height of the corridor

Corridors

Typically, an occupant leaving a suite enters a corridor which is shared with other tenants. These corridors are designed to offer an area of relative safety to enable them to reach an exit. The *NBCC* calls such corridors public corridors.

FIGURE 8.6
Public corridor divided from floor area by rated fire separations

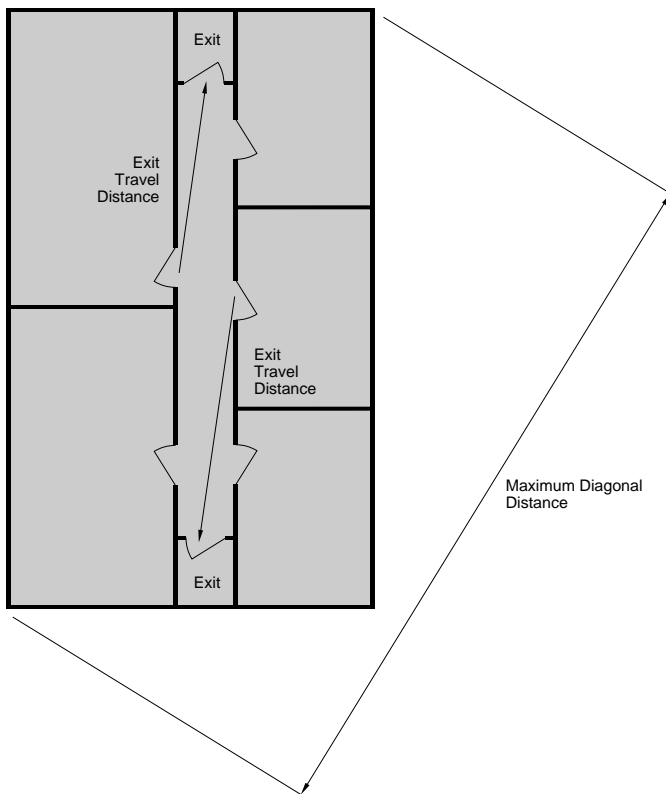

When a floor area has been subdivided by at least 45 minute fire separations to serve more than one tenant, the travel distance is measured along the path of exit travel within the public corridor from the door of the room or suite to the nearest exit. Again, the longest travel distance must not exceed distances listed in Subsection 3.4.2. Also exits must be as far apart as practicable. The least distance between exit should be 1/2 the maximum diagonal dimension of the floor area, but need not exceed 9m.

Public corridors are defined as: “a corridor that provides access to exit from more than one suite”.

These should not be confused with “corridors used by the public” which serve institutional, assembly, and business and personal services occupancies that do not have multiple tenants.

3.3.1.9. The *NBCC* also regulates corridors serving patients’ bedrooms or classrooms which may be used by the public but are not defined as public corridors. These are treated as special corridors and are protected accordingly.

All corridors must be designed to give an occupant the option of two directions to reach an exit in case one route becomes unsafe. This is one of the most important tenets of the *NBCC* philosophy: an alternative escape route should be available unless it is deemed that occupant safety will not be reduced by providing a single exit route.

3.3.1.9.(7) For this reason, the use of dead-end corridors is restricted. However, the *NBCC* recognizes that dead-end corridors are sometimes necessary for the efficient utilization of space. The *NBCC* permits dead-end portions up to 6m with certain restrictions. Longer dead-end corridors are only allowed in residential occupancies where a second means of egress is available from the suite.

3.3.1.4. In most cases, the *NBCC* requires that fire separations with a fire-resistance rating be provided between public corridors used for access to exits and the remainder of

the floor area. The fire-resistance rating requirement is waived but there must still be a fire separation if the floor area:

- is sprinklered
- does not contain a care or detention or residential occupancy

No fire separation is required when such corridors exceed 5m in unobstructed width as in the case of enclosed malls. In such cases, the wide corridor along with the monitored and alarmed automatic sprinkler system, is deemed to provide the necessary protection against fire spread.

Other public corridors which serve as access to exits are also subject to:

- minimum dimensions **3.3.1.9.**
- lighting levels for normal and emergency situations **3.2.7.1.**
- flame-spread limitations, as discussed in Chapter 6 **3.1.13.6.**

3.3.1.9. The *NBCC* specifies minimum widths and headroom clearances for public corridors and doorways used as an access to an exit. However, the capacity of exits and access to exits depends on occupant load. The requirements which regulate width on the basis of the occupant load served by these facilities must govern, if these are more stringent.

In designing widths for access to exits, the likely direction of movement should be considered. In most situations, it is fairly predictable but in complex arrangements involving multiple egress paths, judgement must be exercised to determine the occupant load served by a particular route.



EXITS

3.4.2.1.(1) The *NBCC* requires (in most cases) that every floor area be served by at least two exits. The number and location of exits will depend on:

- the occupancy
- the occupant load
- travel distances

3.4.4.1. Exits must lead to a safe destination and, except for a few minor exceptions, must be separated by fire separations from the remainder of the floor area.

3.4.2.3. It is a *NBCC* principle, that a second exit must be accessible in case the route to the first becomes impassable. Minimum separation distances are imposed in open floor designs. In all cases, exits should be located as far as practicable from each other (Figures 8.5 and 8.6).

3.4.2.1.(2) In small buildings of not more than two storeys in building height, where travel distances are short and occupant load is at most 60, a single exit from a floor area is permissible. This is consistent with requirements for individual suites where a single egress doorway is acceptable for an occupant load of up to 60 persons.

Exits should not be confused with access to exits, (previously discussed). An exit is not part of the floor area. It is a completely separate compartment which leads directly to:

- a separate building
- an open public thoroughfare, or

- an exterior open space which is protected from fire exposure from the building and has access to an open public thoroughfare

It should be remembered that exits also serve regular traffic to and from floor areas. Designers often provide exit facilities for everyday use in addition to the ones required by the building code.

These extra facilities serve a similar function as the required exits, but they are not required to meet *NBCC* requirements for exits. For example, pull stations for fire alarm systems may not be compulsory at such exits. It is good practice, however, to adhere to the same regulations to avoid possible confusion for occupants.

3.4.6. Certain design and building requirements apply to exits. These requirements are intended to reduce the possibility of injury when the facilities are used. Specifications governing features such as direction of door swing, stair treads and risers, guards, handrails and ramp gradient are set out clearly in the *NBCC*.

Exit Requirements

The *NBCC* requirements for the number and location of exits should be taken into consideration in the initial planning of a building. Introducing additional exit facilities at a later stage can prove costly and disruptive

The first step is to determine the occupant load for each floor. Next, the number of exits, location, and

details such as height, width and the fire-resistance rating of enclosing fire separations can be determined, based on occupancy, travel distances and whether or not the floor area or building is sprinklered.

3.4.3.4. The aggregate or total combined width of an exit or exits serving a floor area is determined by multiplying the occupant load of the room or floor area by the number of millimetres of exit width required per person.

This approach to calculating exit widths, based on a certain amount of space per person, replaces the former step function approach used previously in the *NBCC*. This gives designers more flexibility in sizing exit routes to accommodate the flow of occupants expected in an emergency. This approach is usually used for exits which are required to exceed the minimum width.

3.4.2.5.(3) If more than one exit is required from a floor area, no single exit may be considered to contribute more than half of the required exit width. This limitation ensures that alternative escape routes have adequate exit capacity should one exit become inaccessible.

The sequence to follow when determining exit requirements is:

1. Determine the number of exits required based on travel distance and other requirements.
2. Determine the minimum width requirements of the required exits to give an aggregate width of these exits.

3. Establish the minimum aggregate exit width required to provide exit capacity for the occupant load.

If 2 is greater than 3, the requirements have been met. If 3 is greater than 2, the width of the exits will have to be increased to provide for the required width.

3.4.3.1. The clear width of every exit is required to be at least 900mm, with the exception of certain fire escapes which need only be 550mm wide. The minimum width necessary for free travel of a single file of people is considered to be 550mm, but minimum exit widths are usually wide enough to allow for two files of persons, that is, 1100mm.

3.4.3.4. The aggregate width of exits required from a floor area is determined by the occupant load. The required width varies with the mobility of the occupants and the hazard of the floor area served.

3.4.3.5. Exits should not narrow suddenly. This can congest traffic and incite panic. A doorway leading from an exit stairway or ramp will usually be narrower than the stairway or ramp. Sufficient space is necessary so that occupants can adjust to the different rhythms of movement on stairs or on a level surface. Exit width should not be blocked by turnstiles or construction projecting into the exit. Door hinges, swinging doors, handrails or stair stringers are permitted to reduce exit width slightly.



As noted, floor areas must be designed so that the allowable travel distance to an exit is not exceeded. The *NBCC* stipulates (for most cases) that at least two exits be provided from each floor area. For large floor areas, more than two exits might be required if maximum travel distances are exceeded.

3.4.2.5. Generally, maximum travel distances are limited to a range of 25 to 40m, depending on occupancy. However, in storage garages with all storeys constructed as open-air storeys and with no other occupancy above, a travel distance of 60m is permitted because occupant load is limited.

3.4.2.5.(1) Travel distances up to 105m are permitted in sprinklered buildings such as shopping malls, even though suites are not separated from the public corridor by fire separations, provided:

- the public corridor is at least 9m wide
- the ceiling of the public corridor is at least 4m high
- if a room or suite requires more than one egress doorway, only one-half of the egress doorways open into the public corridor

These longer travel distances are permitted because sprinklers will help to control heat, the high ceiling will act as a smoke reservoir, and the large public corridor provides ample exit capacity (Figure 8.7).

As previous chapters note, exits require special protection:

- exits must be enclosed by fire separations with a fire-resistance rating at least equal to that of the floor assembly **3.4.4.1.**
- finish materials must have low flame-spread ratings **3.1.13.2.**
- penetrations of the fire separations which enclose exits must only accommodate building services that are necessary to the exit **3.4.4.4.**

3.4.5.1. *NBCC* regulations for means of egress constitute minimum requirements. Designers should make every effort to ensure the integrity of exits because they constitute the lifeline between floor areas and the street. As well, exit routes, including those providing access to exits, must be clearly marked with exit signs to direct occupants during a fire.

FIGURE 8.7

**Public corridor
not divided
from floor area
by rated fire
separations**

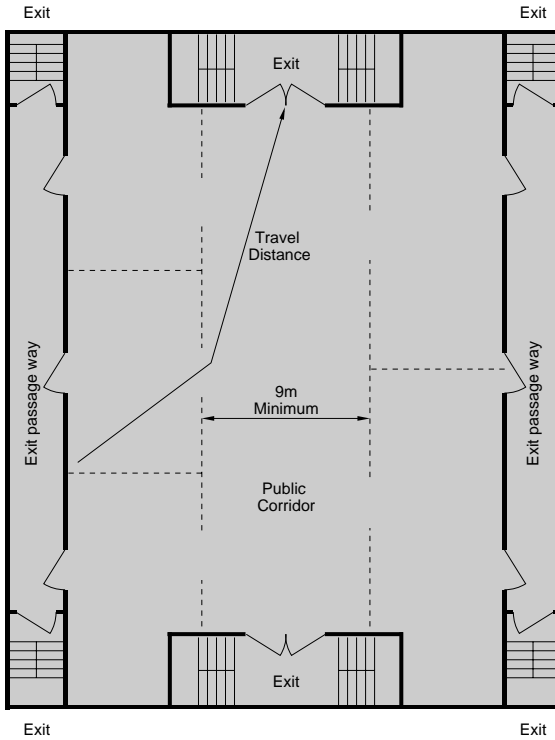

When a floor area is not subdivided by rated fire separations and is served by a 9m wide public corridor, the travel distance is measured along the path of exit travel within the floor area. The maximum travel distance in this case is 105 m. Also, if more than one egress door is required from a room or suite, no more than 1/2 of the egress doors may open into the public corridor. The building must be sprinklered, and ceiling height in the public corridor can not be less than 4 m.

8.5 Safety within Floor Areas of Specific Occupancies

There are a number of other requirements affecting safety which concern specific occupancies.

ASSEMBLY OCCUPANCIES

Requirements for assembly occupancies relate primarily to:

- the protection of these spaces from adjacent occupancies **3.3.2.2.**
- the detailed treatment of seating arrangements to ensure that egress will not be impeded by inadequate aisles and exit capacity **3.3.2.3 & 3.3.2.4**

The safety hazard of an assembly occupancy is the large number of people gathered in a public place with which they are not necessarily familiar. The fire load due to the combustible contents of an assembly occupancy is generally low. The potential hazard to safety is, however, increased by the necessity of rows of seating, tables and other obstructions to movement that restrict direct access to exits across a floor area (Figure 8.8).

3.3.2.9. Outdoor places of assembly have separate requirements, since a large number of people in an open space constitutes a unique situation. Less stringent measures apply to outdoor assembly structures because smoke should be able to dissipate into the open space in front of the seating area.

Also, access is usually available to the open space behind the seating area by means of aisles and passageways. Where barricades serve

to confine spectators or restrict access onto a playing field, special consideration should be given to the egress design.

RESIDENTIAL OCCUPANCIES

In residential buildings, the main concern is that occupants may be asleep when a fire occurs, and considerable time may elapse before an emergency is realised and evacuation begins. Each dwelling unit must:

- be separated from adjacent dwelling units by fire separations **3.3.4.2.**
- provide egress that accommodates various types of designs while maintaining an appropriate level of safety **3.3.4.4.**

3.3.4.2. If a storage garage is attached to a dwelling unit and serves only that unit, no fire separation is required between the unit and the garage provided:

- the unit and the garage are separated from the rest of the building by at least a 45 minute fire separation
- there are no duct systems between the garage and the unit
- the wall between the unit and the garage is an effective barrier to gas and exhaust fumes
- any door between the unit and the garage is tight fitting, weather-stripped, fitted with a self closing device, and not in a bedroom



FIGURE 8.8

Fixed seating restricts access to exits



3.3.4.2.(4) The wall between a garage serving more than one dwelling unit and any dwelling unit can be a fire separation with no fire-resistance rating provided the following conditions are met:

- the garage contains no more than five vehicles
- the building is sprinklered
- the conditions listed previously for a garage serving a single unit are met

CARE FACILITIES

The *NBCC* recognizes that in occupancies such as hospitals and nursing homes, normal egress procedures from upper floors are not applicable because occupants cannot evacuate the floor area without assistance from security, nursing or other personnel.

Therefore there must be provisions to permit occupants to remain inside an institutional building for an extended period of time during an emergency. This is the Defend Exposed in Place objective of the NFPA Fire Safety Concepts Tree.

3.3.3.5. To achieve this objective, more rigorous fire protection measures are required. In the 1995 *NBCC*, all buildings of care or detention occupancy must be equipped with automatic sprinklers. In addition, during an emergency, it is often safer to move bed patients occupying a floor area to a safer adjacent area.

To permit the horizontal movement of patients to relative safety, these floor areas must be divided by fire separations into two or

more fire compartments. Each compartment must not exceed 1000m². Such zones must be large enough to hold their own occupants plus the occupants of the largest adjacent zone.

REPAIR AND STORAGE GARAGES

Occupancies such as repair and storage garages are subject to additional restrictions because of increased hazards and sources of ignition. The concern with storage

garages relates mostly to the potential carbon monoxide contamination of adjacent spaces. These additional restrictions include:

- provision of mechanical ventilation **3.3.5.4**
- fire separation from other occupancies **3.3.5.5. & 3.3.5.6.**

As noted, the fire resistance rating of the fire separation between storage garages and a dwelling unit can be waived in some instances.

8.6 Service Spaces

3.6.1.1. Section 3.6 of the 1995 *NBCC* regulates spaces which house building service facilities such as:

- ducts and pipes
- electrical wires and cables
- electrical transformers and switchgear
- heating furnaces, incinerators and boilers
- air-conditioning and mechanical equipment
- elevators, dumbwaiters and escalators

Such service spaces include attic and roof spaces, ceiling spaces, crawl spaces, elevator hoistways and shaft spaces, as well as specialized service rooms. Service spaces are normally unoccupied areas, but must be regulated because a fire may ignite within them, or they may be routes for the spread of a fire.

3.2.1.1.(7) The *NBCC* provides for access to some service spaces to permit maintenance and to aid firefighting. These special spaces

or interstitial spaces are not considered as a storey if they meet a number of special requirements .

3.6.2. Apparatus such as fuel-fired equipment, incinerators or transformers present a particular hazard because they have potential to start fires. The *NBCC* therefore requires that , under certain circumstance, rooms containing them be separated from the remainder of the building by fire separations with a designated fire-resistance rating. Conversely, some service rooms contain equipment belonging to the building's emergency systems, and must be protected from a fire originating elsewhere.

3.6.3.1.(1) Vertical service spaces such as shafts for building services, enclosures for linen or refuse chutes, and dumbwaiters and elevators, must be separated from each adjacent storey by fire separations with a fire-resistance rating based on that of the floor assembly through which they pass.

FIGURE 8.9
Vertical service spaces

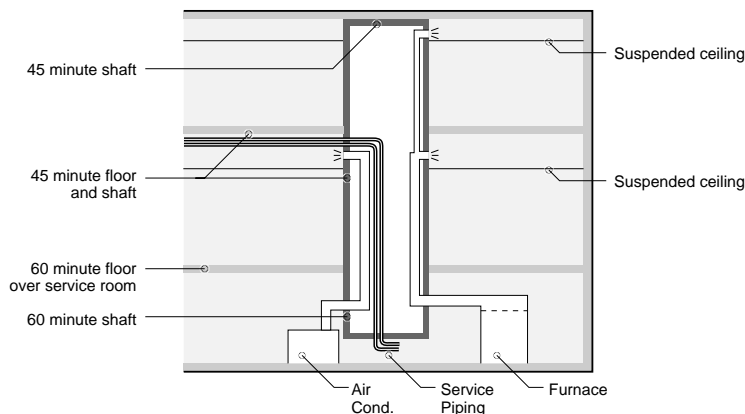

Shaft must provide 60 minute fire separation at bottom and 45 minute where it passes through the first and second storey and at the top; interior finish of shaft must have flame-spread rating of 25 or less.

This ensures that the degree of protection for that space is in keeping with the expected severity of a fire on each floor area (Figure 8.9).

3.1.13.2. The interior wall surfaces of service shafts are limited to a flame-spread rating of 25.

3.1.13.7. In high buildings, the smoked developed classification of interior finishes in vertical service spaces is also regulated and must not exceed 50. This requirement is intended to limit the potential smoke hazard should a fire occur in the space.

3.6.3.3. Refuse and linen chutes are notorious for nurturing fires because ashtrays with smouldering cigarette butts are often dumped into them. For this reason, the chutes, as well as the rooms in to

which they discharge, must be sprinklered, and additional fire safety requirements are also imposed.

Chapter 5 explains that when a ceiling space is continuous above a fire separation, it is treated as a separate fire compartment. The ceiling must then be constructed as a fire separation with a designated fire-resistance rating (Figure 8.10).

3.6.5.4. If the concealed space is used as a plenum for heating, ventilating and air conditioning systems, the *NBCC* imposes restrictions on the types of materials which may be used within that space to reduce the possibility of the spread of fire and smoke through these service areas to the rest of the building.

3.2.1.1.(1) Roof-top enclosures, such as elevator machinery rooms, due to their low occupant load, may

FIGURE 8.10
Horizontal service spaces

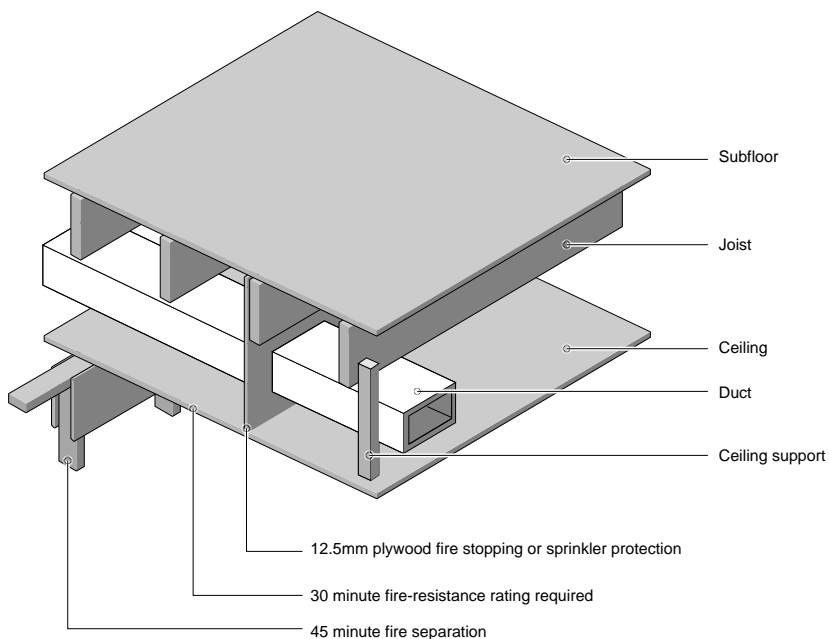

be omitted from the storey count in calculating building height. Therefore, a roof-top enclosure on a four-storey wood-building may also be of wood-frame construction.

3.2.2.14. Enclosed service rooms on top of roofs must maintain the required fire separation of the floor assembly between the service room and the storey below. The fire-resistance rating of the enclosure is waived if it is not more than one storey high. No fire separation is necessary beneath unenclosed roof-top equipment.

Wood-frame enclosures for service rooms containing heating and

cooling equipment are restricted to buildings permitted to be of combustible construction. Other wood components besides the structural members may be used in service rooms. Doors may be constructed of wood or wood-based materials.

Even where combustible construction is permitted, the use of wood may be limited by the degree of hazard involved, as in incinerator rooms that require not less than a two-hour fire separation. However, two layers of 15.9mm Type X (fire-resistant) gypsum wallboard on wood-stud framing can give the required fire-resistance rating, thus providing the fire separation.

Chapter Summary

The primary objective of the *NBCC* is to ensure life safety. This can be achieved by a combination of measures designed to manage the fire and manage the people in accordance with the NFPA Fire Safety Concepts Tree.

The Manage Exposed branch relies on three steps:

- initiating the movement of the occupants by alerting them to the emergency
- providing means for occupants to move safely within the building to an exit
- ensuring that exits will lead to a safe destination

Certain occupancies are given special consideration due to hazards related to the occupancy as well as to the ease of occupants to evacuate the building. The provision of early warning and detection systems combined with facilities to aid firefighting (standpipes and sprinklers) are all part of the overall passive and active life safety systems provided in a building to ensure public safety.

The level of risk is reduced when a floor area or building is sprinklered and consequently, the requirements are not as stringent in these cases.





9



Provisions for Firefighting

9.1	General Information	303
9.2	Access to Buildings	305
	Access Routes	305
	Access Above Grade	308
	Access Below Grade	308
9.3	Fire Protection Systems	311
	Water Supply	311
	Sprinkler Systems	311
	Standpipes	316
	Portable Fire Extinguishers	317
	Chapter Summary	317



9.1 General Information

Fires are usually controlled by

- applying cooling agents, usually water, to absorb heat and reduce fuel temperatures
- by using an isolating agent, such as foam, to separate the fuel from oxygen and smother the fire

During a fire, heat may build up rapidly, and quickly heat additional fuels, such as building contents, to their ignition temperature. A small fire, once it reaches flaming conditions, can get out of control within two or three minutes.

It is vital that a building be arranged so that any fire can be reached quickly. As well, manual or automatic fire suppression systems must be well designed and well maintained.

In the NFPA Fire Safety Concepts Tree, firefighting provisions and building access fall under the Manage Fire Impact branch, including both Manage Fire and Manage Exposed. To meet these requirements, access facilities must

be provided and maintained to permit fire department personnel to:

- reach the site
- evaluate and suppress the fire in the building
- reach those exposed to the fire

Access may mean evacuation or protection of the building occupants in place. More stringent requirements apply to high buildings (Chapter 10) because of their higher occupant load, and restricted access and exiting which limit efforts to manage the exposed.

The spatial separation requirements discussed in Chapter 7 are designed to reduce the likelihood of fire spreading between buildings. The separation and construction limits are based on typical radiation levels experienced during a fire, and the assumption that firefighting is available within 10 minutes of the alarm being received.

Access routes for firefighters allow firefighting apparatus to be placed near hydrants and near buildings.

Access routes for firefighters provide a means for firefighting apparatus to be placed near hydrants and near buildings for evacuation purposes.



9.2 Access to Buildings

3.2.2.10. Every building is required to face at least one street to provide firefighting access. Access routes provided on the property are permitted to be considered as streets when determining the minimum construction and fire protection requirements (except when determining spatial separation requirements).

3.2.5.4. Any building which is more than three storeys in building height or more than 600m² in building area must have at least one access route on the property. For these larger buildings, the access routes must be adjacent to the principal entrance and to any building face required to face a street.

3.2.5.5. For smaller buildings required to face only one street, the access route can be anywhere within 45m of any portion of the building. This is because small buildings contain fewer people, are easily evacuated, and thus present a lesser risk to life.

Access is maintained for two types of emergency response:

- vehicles which must access the building directly, such as ambulances and ladder trucks
- pumper trucks, which boost water supplies from the municipal supply to the building either via a hose stream or through a service connection

A building's fire service connections are commonly siamese connections which access a building's sprinkler and/or a standpipe and hose system (Figure 9.1). The fire service can ensure that pressure for these systems is maintained by pumping water from a remote supply (usually the municipal system) through the siamese.

ACCESS ROUTES

3.2.5.6. The route which provides emergency access to a building must be connected to a public thoroughfare so that fire department equipment can be driven unimpeded to the scene of the fire.

FIGURE 9.1

Typical exterior standpipe and sprinkler connections

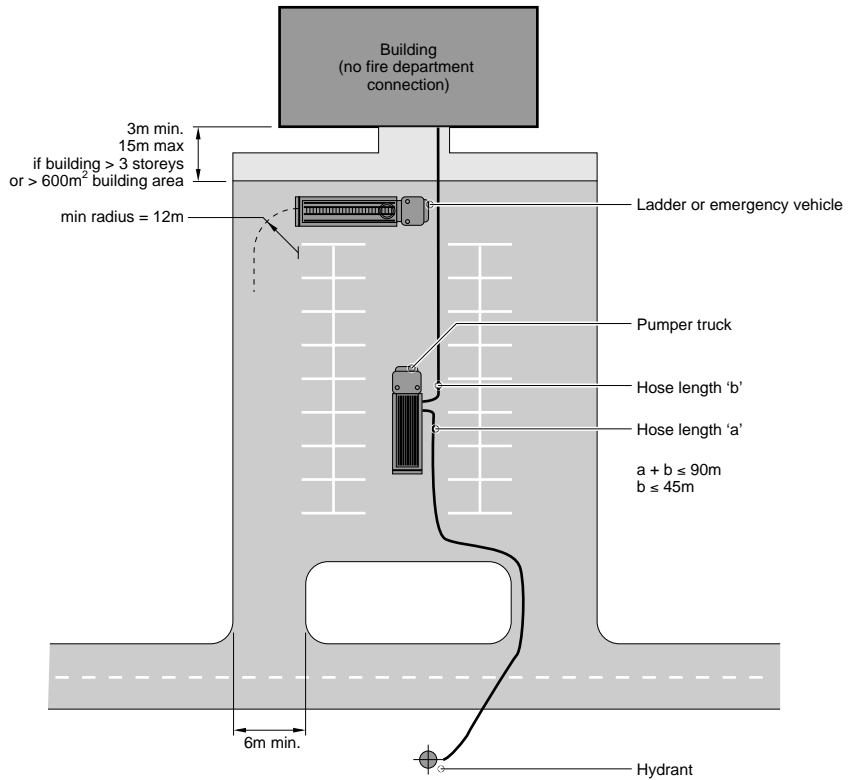

FIGURE 9.2

Building access

Each access route must be designed to the following criteria (Figure 9.2):

- be surfaced with concrete or asphalt
- be able to support the weight of fire department equipment
- minimum clear width of 6m
- minimum overhead clearance of 5m
- minimum centreline radius of 12m
- no change in gradient exceeding 1 in 2.5 over 15m
- turnaround facilities in dead-end portions exceeding 90m

3.2.5.5.(1) The location of the access route must allow access directly to the building and also to the water supply system. To permit direct access for ambulances and ladder trucks, the access route must be situated so that it is:

- not less than 3m
- not more than 15m

from the principal entrance and access openings (Figure 9.2)

One of the first actions of a responding fire department is to connect to the hydrant closest to the building. The location of the

access route must also consider access to hydrants and to fire department connections on the building.

3.2.5.16 For buildings with fire department connections to a standpipe or automatic sprinkler system:

- the roadway or yard must be adjacent to the hydrant
- the connection must be not more than 45m from the hydrant

3.2.5.5.(2) For buildings without fire department connections:

- there must be a fire hydrant within 90m of the building
- paved access must not be more than 45m from the building

These requirements allow a pumper truck to get close enough to easily boost a hose stream to the fire without excess friction loss in the hoselines.

3.2.5.5.(4) Internal partitions create divisions which limit the area accessible to the fire department through the principal entrance. There is a 45m limit on travel distance from the access route to one entrance of each divided portion of buildings.

3.2.2. The tables of allowable heights and areas (Chapter 4) are divided according to the amount of firefighting access provided for unsprinklered buildings. An unsprinklered building facing three streets is permitted to be greater in building area or building height than one facing only a single street.

3.2.2.10. To be considered as facing two streets, 50% of the building perimeter must be located within 15m of a street or access route. For facing three streets, at least 75% of the building perimeter must be within 15m of a street or access route.

The improved accessibility provides better means for evacuating the occupants and for attacking the fire from both inside and outside the building.

In the 1995 *NBCC*, the height and area of sprinklered buildings do not change according to the amount of access provided. The heights and areas allowed by the previous edition of the *NBCC* for facing three streets are now permitted for sprinklered buildings facing only one street.

This change is based on the following:

- Previous editions of the *NBCC* did not require access openings (windows, doors) for firefighting purposes in any wall of a building or storey that was sprinklered. Since no openings were required, the need for street access on two or three blank wall faces of a sprinklered building was questioned.
- Properly designed and maintained sprinkler systems, which are electrically supervised, have a high level of reliability.
- The sprinkler system is able to apply water directly to a fire, and the fire department can boost water pressures into the sprinkler system if necessary.



ACCESS ABOVE GRADE

3.2.5.1. The importance of attacking a fire from the interior positions is reflected in the *NBCC* by the requirements for direct access into buildings. Firefighters must have direct access to every above-grade storey that is not sprinklered and whose floor level is less than 25m above grade. Access must be provided by at least one unobstructed window or access panel for each 15m of wall face, measured horizontally.

These access panels must be located in a wall facing a street or access route so that firefighting equipment, such as hoses and ladders, may be brought up to the access panel and into the building.

Although not specifically stated in the *NBCC*, these access openings should be spaced regularly along the building face to provide optimum access to all areas.

3.2.5.1.(3) Access panels above the first storey should be:

- easy to open from both inside and outside of the building, or
- glazed with plain glass that can be readily broken

3.2.5.1.(2) A maximum window sill height of 900 mm above the inside floor is specified to prevent fire-fighters from injuring themselves while entering the building.

Fire department access by windows, doors or access panels is also required for the first storey of a building because firefighters cannot always enter by the front entrance or the exit facilities of a building.

Access openings are not required for any storey, above or below grade, that is sprinklered. This reflects the ability of sprinklers to extinguish fires in their early stages. Often, when firefighters arrive at a sprinklered building, the fire is either out or under control.

ACCESS BELOW GRADE

Storeys below grade are considered a serious fire hazard because :

- they are often cluttered with combustibile materials
- they are difficult to ventilate
- they are difficult to enter during a fire

3.2.5.2. Access to any unsprinklered basement having a horizontal dimension more than 25m must be provided by:

- doors, windows or other facilities leading from the outdoors from at least one street, or
- an interior stairway that is immediately accessible from the outdoors

This allows firefighters to bring in fire hose directly without going through other parts of the building (which may already be inaccessible due to the fire). If the basement is sprinklered, access openings are not required.

3.2.2.15. If the building extends more than one storey below ground level, all basement storeys must be sprinklered (except for residential occupancies).

3.2.2.15.(3) In an unsprinklered residential building, the basement storey directly below the first storey is not required to be sprinklered if at least one unobstructed access opening is installed on that storey for each 15m of wall length in at least one wall required to face a street. This exception is allowed to accommodate the use of parking levels below residential buildings.

9.3 Fire Protection Systems

WATER SUPPLY

Water supply required for fire-fighting purposes for any building depends on:

- building size
- combustibility of building contents
- combustibility of the structure
- level of hazard associated with the occupancy
- exposure hazard from neighbouring buildings
- whether or not the building is sprinklered
- whether or not a standpipe system is provided

In crowded districts of larger municipalities, the possibility of two or more fires creating a simultaneous heavy demand on the public waterworks system must be considered.

3.2.5.7. A water supply system should be designed, installed and maintained to provide an adequate water supply for fire-fighting purposes. The public waterworks system often has to be supplemented to provide an adequate quantity and pressure of water required to protect large buildings. A secondary water supply system is often provided consisting of:

- fire pumps and reservoirs
- pressure tanks or gravity tanks
- private hydrants and fire mains

3.2.5.5.(2) Although not explicitly stated in the *NBCC*, a hydrant is required to be located

in close proximity to any building required to have access routes for fire department vehicles, as specified in Article **3.2.5.4.**

A number of National Fire Protection Association (NFPA) standards provide guidance on the installation of private water systems and methods for determining minimum water supply requirements.

SPRINKLER SYSTEMS

For the 1995 *NBCC*, the provisions requiring sprinklers and the fire protection requirements for buildings with sprinklers were examined in depth. This resulted in sprinklers being required for many more types of buildings (Chapter 4). The provision of sprinklers however permits a relaxation of many Code requirements such as:

- an increase in the heights and areas permitted
- a reduction in the spatial separations required
- a reduction in the access required
- a reduction in fire-resistance ratings

The advantage of having sprinklers ready at all times to immediately discharge water on a fire is recognized by these relaxations. The excellent record of sprinkler systems is affirmed in several recent reports. These emphasize the important role that these systems play in reducing fire losses in all types of construction.

Obviously, the presence of automatic fire sprinklers in a building also plays a significant role in the

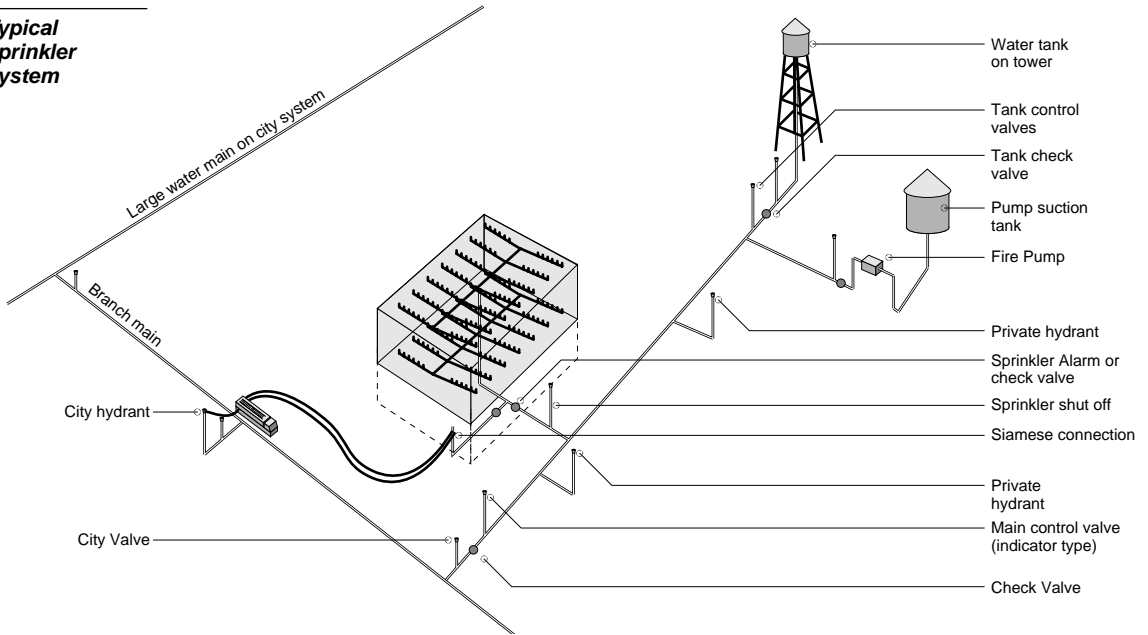

FIGURE 9.3

**Typical
sprinkler
system**

fire department's response in a fire situation. Usually, firefighters will connect to the fire department pumper connection and boost the pressure in the sprinkler system to ensure that an adequate supply of water reaches the fire (Figure 9.3).

In many cases, the fire is controlled by one or two sprinklers, and the fire department need only shut off the system and assess the damage.

Installation

Automatic sprinkler protection is a proven means of safeguarding property from fire, but like any other fire protection system, it must be installed and maintained properly to ensure proper function when a fire occurs.

3.2.5.13. Automatic sprinkler systems, where required, must be designed, constructed, installed and tested in conformance with:

- NFPA 13, *Standard for the Installation of Sprinkler Systems*, or
- NFPA 13R, *Standard for the Installation of Sprinkler Systems in Residential Occupancies up to and Including Four Stories in Height*, or
- NFPA 13D, *Standard for the Installation of Sprinkler Systems in One- and Two-Family Dwellings and Mobile Homes*.

FIGURE 9.4

Sprinkler system controls require periodic verification



3.2.5.13.(2) NFPA 13R is permitted to be used for a building of residential occupancy throughout, not more than 4 storeys in building height. NFPA 13D is permitted to be used for a building of residential occupancy throughout that contains not more than 2 dwelling units.

3.2.5.13.(7) NFPA 13R and NFPA 13D are residential sprinkler standards that have only been recognized by the *NBCC* since 1993. The *NBCC* requires fast response residential sprinklers which activate much more quickly than traditional commercial sprinklers. With these fast-acting sprinklers, the fire in the room of fire origin is controlled much earlier, thereby reducing both property and human losses.

Neither of the residential standards require sprinklers to be installed in unused concealed spaces such as attics and floor spaces or in some small closets and washrooms. Statistics show that fires originating in such spaces do not significantly impact the number of deaths or injuries.

The cost of sprinklering residential properties using these standards is reduced significantly (especially for wood-frame construction) because:

- many of the combustible concealed spaces do not have to be sprinklered
- the water supply for the sprinkler system installed to NFPA 13R is less than required under NFPA 13

3.2.5.13.(7) Fast response sprinklers must also be used for care or detention occupancies. Since most people in these occupancies have restricted mobility, it is critical that the sprinklers activate as fast as possible to ensure tenability levels in the room of fire origin are maintained.

The provisions of NFPA 13 allowing fast-response sprinklers apply to most other occupancies covered by the *NBCC*, including high-challenge warehouse occupancies.

Sprinkler systems are usually installed throughout a building and, in most cases, the *NBCC* requires complete protection for the building. In some cases, the *NBCC* requires only the floor area or space to be sprinklered and not

the entire building (depending on the hazard being protected and the nature of the fire safety issue).

3.3.2.5.(3) For example, the fire-resistance rating of corridor walls in certain occupancies is waived if the floor area is sprinklered. This is logical because the requirements for fire-resistance ratings providing passive fire protection are typically applied floor-to-floor, based on the occupancy hazard on the floor.

3.2.5.13.(6) However, to avoid having a fire-resistance rating required for a roof assembly, the entire building must be sprinklered, due to the greater impact of a roof failure. Since the rating of the roof assembly is waived, all rooms in the storey immediately

FIGURE 9.5

Firefighting Equipment (R to L): firefighters' telephone, standpipe and hose cabinet with 38 and 64mm connections, portable fire extinguisher, manual alarm and fire exit



below the roof assembly must be sprinklered, including those rooms not otherwise required to be sprinklered by the applicable sprinkler standards.

As noted, the design standard, NFPA 13, typically requires sprinklers to be installed throughout the building, including any concealed spaces containing combustibles or exposed combustible surfaces.

There are, however, many instances where sprinkler protection is waived for these concealed spaces even in buildings of wood-frame construction. Some of these combustible concealed spaces include:

- spaces filled entirely with noncombustible insulation
- spaces formed by ceilings attached directly to, or within 152mm of wood joist construction
- spaces where the exposed surfaces have a flame spread rating of 25 or less and the materials do not propagate fire in the form in which they are installed in the space, (for example, fire retardant treated wood)

Additional information on spaces that are exempt from sprinkler protection in wood frame construction can be found in NFPA 13.

Although both NFPA 13 and NFPA 13R allow certain areas of wood frame construction to be unsprinklered, the building is still considered as sprinklered throughout. Consequently, any option in the *NBCC* afforded to sprinklered buildings apply, even with these unsprinklered portions in the building.

Figure 9.3 shows a typical sprinkler system and the outside water supply services. The design and installation of these systems is complex, since the requirements vary with construction type and occupancy. Designers and installers must have extensive, specialized knowledge.

In general, sprinklers are installed on a fixed piping system throughout the building. They are typically installed as :

- wet pipe systems (water always in the piping) or
- dry pipe systems (air filled pipe with differential valve holding back the water)

3.2.5.14. Dry pipe systems are used mainly in areas subject to freezing. The *NBCC* requirements do not usually specify the use of one type of sprinkler system over the other except that plastic piping is restricted to wet pipe systems.

Sprinklers are fixed temperature detectors. They are equipped with fusible solder links or frangible bulbs and will activate only when the design temperature is reached. The design temperature ranges from 38°C to 329°C depending on the occupancy and the hazard.

Only the sprinklers located in the immediate area of the fire will reach their design temperature and activate. The number of sprinklers operating will depend on the severity of the fire and the adequacy of the water supply.



Water Supply

The minimum water supply required for the system depends on:

- the building occupancy
- the construction type
- the design approach used to size the system branch lines and feed mains

The hydraulic design approach calculates flow rates and pressure losses in the system. It is commonly used and usually results in much lower water supply requirements than other design approaches, especially for wood-frame buildings.

The NFPA's *Automatic Sprinkler Systems Handbook* and *Fire Protection Handbook* provide extensive background and explanation on the design and use of all types of automatic sprinkler systems. These documents are recommended to all sprinkler system designers who must interpret the standards for fire protection systems installed to meet *NBCC* fire safety requirements.

STANDPIPES

Standpipe and hose systems are almost always needed in unsprinklered buildings, and in portions of buildings that cannot be accessed easily with hose lines from outside hydrants.

3.2.5.8. The *NBCC* requires standpipe and hose systems for any building:

- more than three storeys in building height

- more than 14m in height between grade and the ceiling of the uppermost storey
- unsprinklered and less than 14m in height and more than the building area listed in Table 3.2.5.8. of the *NBCC*.

Standpipe systems are designed for two types of service:

- Small (38mm diameter) hose attached to the standpipe outlet are intended for use by occupants of a building to help control the fire until firefighters arrive.
- Larger (64mm diameter) connections are provided for the 64mm diameter hose which is brought into the building by the firefighters.

These two types of service are usually provided by a single standpipe with separate valve outlets provided to connect 38mm diameter and 64mm diameter hose (Figure 9.5).

3.2.5.10.(5) Where a standpipe and hose system is provided in an unsprinklered building less than 25m in height, the *NBCC* permits the exclusive use of 38mm diameter hose connections.

A 38mm diameter hose is adequate for attacking the majority of fires that can be fought with inside hose lines. Both building occupants and firefighters can use 38mm hose but the use of 64mm diameter hose is limited to firefighters.

3.2.5.10.(1) Standpipes should be located in areas where the chance of mechanical or fire damage is the least. The large 64mm hose connections must be located close to or in an exit so that they will be readily available to firefighters. Some municipalities will not permit standpipe outlets to be located in stairways, while others insist on this location. Therefore the local authority should be consulted in the early design stages.

3.2.5.11.(3) Hose stations for 38mm hoselines must be located in the floor area:

- within 5m of exits
- at other locations to provide coverage to the entire floor area

3.2.5.9.(1) Where standpipe and hose systems are required by the *NBCC*, their design, construction, installation and testing must conform to NFPA 14, *Installation of Standpipe and Hose Systems*, unless the *NBCC* has other specific requirements.

In sprinklered buildings where standpipe and hose systems are required, the sprinkler and standpipe systems typically use a combined riser to supply water to each floor. NFPA 13 provides guidance for the valve arrangements and minimum water supply requirements.

PORTABLE FIRE EXTINGUISHERS

3.2.5.17.(1) Portable fire extinguishers should be located and maintained throughout the building, according to the requirements of:

- the appropriate provincial, territorial, or municipal regulations or,
- the *National Fire Code of Canada 1995* (in the absence of local regulations)



Chapter Summary

This chapter reviewed the *NBCC* requirements which facilitate firefighting. These provisions apply to common building types. In industrial buildings, warehouses and unusual structures, these provisions may not prove sufficient. The *National Fire Protection Association Handbook*, provides additional information.



10



High Buildings

10.1	General Information	321
10.2	Fire Safety in High Buildings	323
	Smoke	323
	Appendix B	325
	Flame-Spread Rating	325
	Elevators	326
	Venting	326
	Central Alarm and Control Facility	327
	Voice Communication	327
	Protection of Electrical Conductors	327
	Testing	327
	Emergency Power Supply	328
	Chapter Summary	328





10.1 General Information

3.2.6.1. High buildings are classified by height and occupancy type. For most occupancy types, (Group A, D, E or F), high buildings are classified as those buildings which are:

- more than 36m in height, measured between grade and the floor level of the top storey, or
- more than 18m in height if there is an increased number of occupants per exit stair

Group C, residential buildings and Group B, care and detention buildings are classified as high buildings if:

- the Group C or Group B occupancy is located more than 18m above grade, or

- floor areas above the third storey are intended for hospital and nursing home use (Group B, Division 2)

3.1.5. All high buildings (regulated by *NBCC* Subsection 3.2.6.) are required to be of noncombustible construction. However, a considerable amount of wood (Chapter 2) is permitted to be used in partitions, exterior walls, finished flooring and stage flooring, interior finish, trim and millwork. With certain minimum restrictions, wood-frame partitions may be used throughout all buildings of noncombustible construction, including high buildings.

10.2 Fire Safety in High Buildings

In high buildings, immediate evacuation of all floors is impossible because of:

- the large occupant load
- considerable vertical travel distances

A main objective of the *NBCC* is to provide safety to occupants for a sufficient period of time to complete evacuation.

This objective is achieved in high buildings by incorporating additional fire safety measures in the design, such as:

- smoke control systems
- increased fire resistance of major structural components

(Design Requirement Tables, Chapter 4)

- automatic sprinkler protection

SMOKE

Smoke is usually the major hazard to occupants of high buildings (Figure 10.1). As explained in Chapter 1, the vertical movement of smoke is caused by pressure differentials in the building resulting from temperature differences at the exterior boundaries of the building.

FIGURE 10.1

Smoke hazards present increased risk in high buildings

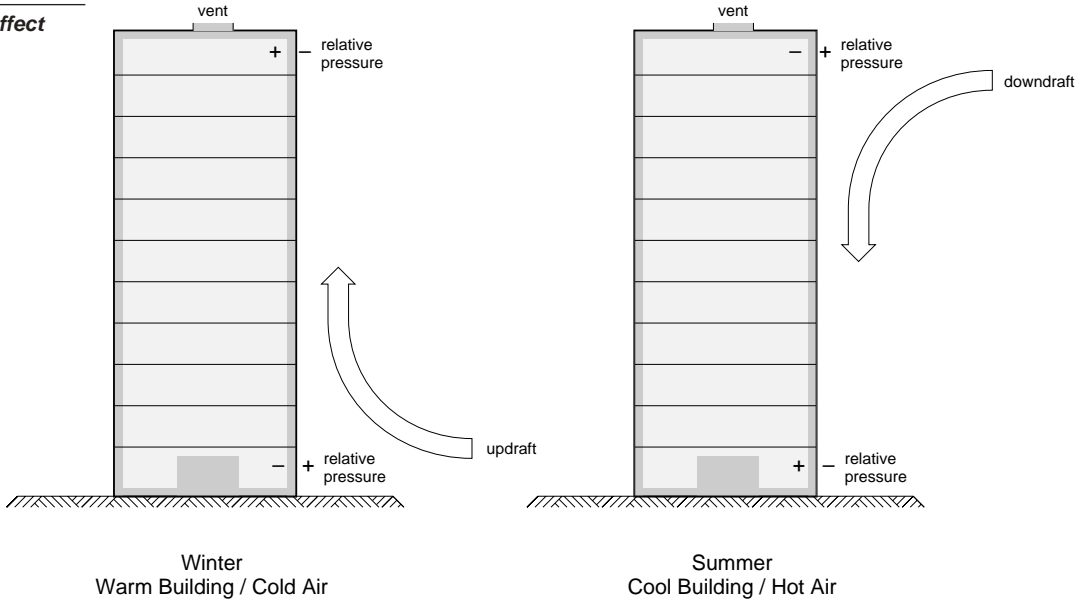

FIGURE 10.2

Stack effect

The heating of a building in cold weather draws air into the building at low levels and discharges it out at upper levels, creating a stack effect. This direction of flow is reversed in the summer when warm air is drawn down by the cooler air-conditioned air. (Figure 10.2)

In a fire situation, the heat generated by the fire results in thermal expansion of the gases. Smoke and hot gas are forced out of compartments by the air currents created by a fire that has reached flashover. Stack effect in high buildings magnifies this effect, increasing the hazard even more. Air handling systems and vertical shafts in the buildings also contribute to vertical smoke movement.

3.2.6.2. In the 1995 *NBCC*, all buildings over six storeys are required to be sprinklered. Even though sprinklers will hold a fire in check in the early stages, floor areas will still tend to fill with smoke. To ensure that evacuation is possible, stairs must be separated and pressurized during a fire emergency. Pressurization of stair shafts keeps smoke and hot gases out of the stairways.

Vented or pressurized vestibules are used to counteract pressure differentials between floor areas and shafts, helping to control smoke movement. Similarly, pressurization can prevent smoke from entering shafts containing elevators for firefighters.

APPENDIX B

Appendix B of the *NBCC* entitled, *Fire Safety in High Buildings*, gives direction for the design of fire safe construction for high buildings.

The measures described in Appendix B are intended to control smoke movement caused by stack effect and other phenomena. The measures vary for building height, occupancy type and size, and illustrate acceptable ways of achieving the same level of safety for buildings of different design.

They are not intended to exclude any other equally effective measure for controlling smoke movement in high buildings. However, the incorporation by a designer of one of the measures is considered to be an acceptable means of complying with the *NBCC*.

Various conditions and combinations of protection are considered in Appendix B, such as:

- automatic sprinklers
- vented corridors and vestibules
- pressurized stair shafts
- pressurized buildings
- vertically divided buildings

A designer should consult Appendix B to understand the intent of the requirements of Section 3.2.6. and how to meet them.

FLAME SPREAD RATING

3.1.13.7. For high buildings, stricter limits than those required for low-rise buildings are imposed

on the flame-spread rating (FSR) and the smoke developed classification (SDC) of interior finish materials.

High-rise buildings are the only buildings where FSR and SDC of floor coverings are regulated with a maximum flame-spread rating of:

- 25 for floors in exits and service spaces
- 300 for floors in corridors, elevator cars and vestibules

There are no limits imposed on flame-spread rating on floor coverings in other areas of the building.

TABLE D-3.1.1.B Hardwood and softwood flooring (either unfinished or finished with a spar or urethane varnish coating) is assigned flame-spread and smoke developed classifications of 300 (Appendix D). This permits these floorings to be used throughout high buildings except in specific exit areas and service rooms.

3.1.13.7.(2) Provided the high building is sprinklered throughout:

- the smoke developed classification requirements for wall, floor and ceiling finishes are waived, except in care and detention buildings and elevator cars
- the less restrictive flame-spread rating requirements for interior finish in other buildings, as detailed in Article 3.1.13.2., apply

In most instances wood trim, millwork and doors are permitted.



ELEVATORS

3.2.6.4. Elevators are controlled by key-operated switches, located conspicuously at:

- each elevator lobby at the recall level
- the central alarm control facility
- each elevator car

These switches enable the cars, including elevator cars on independent key-operated service, to be brought down to the recall level. Once in the control of firefighters, the switches allow operation of the elevator car independently of floor call buttons.

3.2.6.5. At least one elevator for firefighters is required. This elevator must:

- be constructed in accordance with specifications of Article 3.2.6.5.
- be available at the storey having the entrance intended for fire-fighter access
- have an elevator shaft designed to be kept free of smoke
- have a power supply which is protected from fire to ensure its availability to access upper floors

VENTING

3.2.6.6. Means of venting each floor area must be provided by:

- smoke shafts
- windows or wall panels, or
- the building exhaust system

FIGURE 10.3

Firefighters' control panel

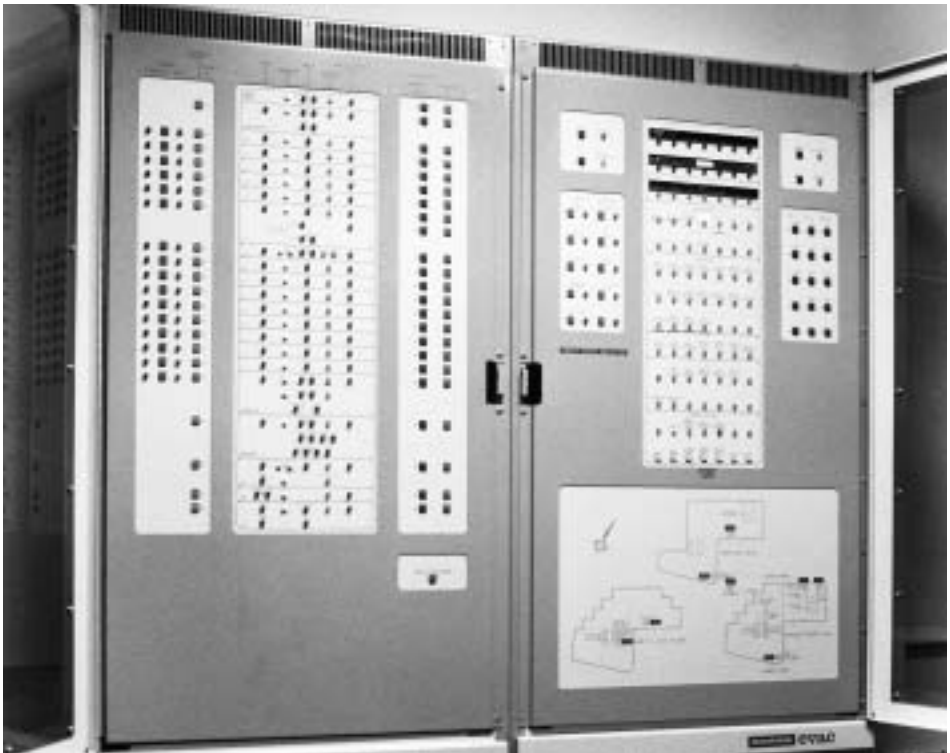

Venting is necessary to exhaust unburned combustion gases and prevent explosions. Appendix B of the *NBCC* describes various solutions for venting depending on which features are selected.

Windows used for venting must be suitably identified and capable of being opened. It is not acceptable to provide venting by breaking window glass because this would endanger people in the street below.

CENTRAL ALARM AND CONTROL FACILITY

3.2.6.7. A central alarm and control facility must be provided on the storey containing the entrance for firefighter access to allow fire-fighting to be co-ordinated from a central facility (Figure 10.3). This facility must have means to control the voice communication and alarm systems in the building.

This facility must be located so that it is readily accessible to firefighters entering the building. Its location should also take into account background noise that occurs in fire emergencies which could hinder operations.

VOICE COMMUNICATION

3.2.6.8. For buildings more than 36m high, or buildings designed or intended for hospital or nursing home use above the third storey, a voice communication system is necessary to:

- direct occupants to safety
- maintain effective communication between floor areas and the central control facility

Two-way radio sets used for communication by firefighters tend to be screened by the massive structural frame of a high building and are not effective.

3.2.4.22. The voice communication system must consist of:

- a two way communication system between each floor area and the control centre
- loudspeakers operated from the central control facility that are audible clearly in all parts of the building

PROTECTION OF ELECTRICAL CONDUCTORS

3.2.6.9. Electrical conductors must be designed or installed so that they are protected from fire exposure, for not less than one hour. This ensures operation of essential services during a fire emergency.

Electrical conductors serving the emergency power supply must remain protected from fire exposure for two hours. Copper-jacketed mineral-insulated cable has been shown by test to carry its full electrical load under CAN/ULC-S101 fire exposure conditions for this length of time.

TESTING

3.2.6.10. Because of the significant hazard of smoke in high buildings, testing of the systems for control of smoke movement and mechanical venting systems is required.



EMERGENCY POWER SUPPLY

3.2.7.8. An emergency power supply must be provided as an alternative to the normal electrical power supply for fire alarm and voice communication systems. The emergency power must be capable of operating under full load for two hours for high buildings.

3.2.7.9. Emergency power supply capable of operating under full load for not less than two hours is required for:

- pumps supplying water for fire-fighting or automatic sprinkler systems
- venting fans
- smoke control fans
- elevators in buildings more than 36m high
- every firefighter elevator

The emergency power supply must be capable of serving all elevators but need only have capacity to supply firefighters' elevators plus one additional elevator at a time.

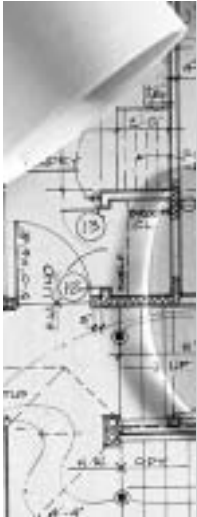

Chapter Summary

High buildings have special requirements because evacuation is complicated by occupant load and travel distances. The *NBCC* gives direction for measures to provide sufficient evacuation time such as:

- smoke control systems
- increased fire resistance of structural components
- automatic sprinkler systems

Other requirements specific to high buildings are also described.



Appendix

Information Sources	331
Index of Tables and Figures	337
Bibliography	341
Index	345
Index of Code References	355

APPENDIX

Information Sources

There are many specialist groups in Canada and the United States which offer technical information on building codes and fire safety and assistance on the use of wood and wood products in building construction.

If you have a technical inquiry and are not sure who to call, contact the Canadian Wood Council in Canada or the American Wood Council in the United States for guidance.

CANADA**Alberta Forest Products Association (AFPA)**

11710 Kingsway Avenue, Suite 200
Edmonton, AB T5G 0X5
Telephone: (403) 452-2841
Fax: (403) 455-0505

*Wood Products
Consumer Information*

L'Association des manufacturiers de bois de sciage du Québec (L'AMBSQ) (Québec Lumber Manufacturers Association)

5055, boul. Hamel ouest, bureau 200
Québec QC G2E 2G6
Telephone: (418) 872-5610
Fax: (418) 872-3062

Lumber

Canadian Codes Centre

c/o National Research Council of Canada
Montreal Road
Ottawa, ON K1A 0R6
Telephone (613) 993-9960
Fax: (613) 952-4040

*Building Codes Development,
Technical Support*

Canadian Commission on Building and Fire Codes (CCBFC)

c/o National Research Council of Canada
Montreal Road
Ottawa, ON K1A 0R6
Telephone: (613) 993-5797
Fax: (613) 952-4040

Building Code Development

Canadian Construction Materials Centre (CCMC)

c/o National Research Council of Canada
Montreal Road
Ottawa, ON K1A 0R6
Telephone: (613) 993-6189
Fax: (613) 952-0268

Building Products Assessment

Canadian Hardwood Plywood Association (CHPA)

27 Goulburn Avenue
Ottawa, ON K1N 8C7
Telephone: (613) 233-6205
Fax: (613) 233-1929

Hardwood Plywood

Canadian Home Builders Association (CHBA)

200, 150 Laurier Avenue W.
Ottawa, ON K1P 5J4
Telephone: (613) 230-3060
Fax: (613) 232-8214

Residential Building

Canadian Institute of Treated Wood (CITW) (Institut canadien des bois traités)

200, 2430 Don Reid Drive
Ottawa, ON K1H 8P5
Telephone: (613) 737-4337
Fax: (613) 247-0540

Treated Wood Consumer Information

Canadian Lumber Standards Accreditation Board (CLS)

103, 4400 Dominion Street
Burnaby, BC V5G 4G3
Telephone: (604) 451-7313
Fax: (604) 451-7343

Lumber Grading, Standards

APPENDIX

Information Sources continued**Canadian Lumbermen's Association (CLA)
(Association canadienne de l'industrie du bois)**

27 Goulburn Avenue
Ottawa, ON K1N 8C7
Telephone: (613) 233-6205
Fax: (613) 233-1929

Wood Products

Canadian Particleboard Association (CPA)

27 Goulburn Avenue
Ottawa, ON K1N 8C7
Telephone: (613) 233-6205
Fax: (613) 233-1929

Particleboard

Canadian Plywood Association (CanPly)

735 West 15th Street
North Vancouver, BC V7M 1T2
Telephone: (604) 981-4190
Fax: (604) 985-0342

Plywood

Canadian Standards Association (CSA)

178 Rexdale Boulevard
Etobicoke, ON M9W 1R3
Telephone: (416) 747-4000
Fax: (416) 747-2475

Material and Design Standards

Canadian Wood Council (CWC)

350, 1730 St. Laurent Blvd.
Ottawa, ON K1G 5L1
Telephone: (613) 247-7077
Fax: (613) 247-7856

*Wood Products: Consumer Information
Codes and Standards
Wood Engineering*

Canadian Wood Preserver's Bureau (CWPB)

c/o Canadian Institute of Treated Wood
200, 2430 Don Reid Drive
Ottawa, ON K1H 8P5
Telephone: (613) 737-4337
Fax: (613) 247-0540

Treated Wood Certification and Inspection

Canadian Wood Truss Association

350, 1730 St. Laurent Blvd.
Ottawa, ON K1G 5L1
Telephone: (613) 247-7077
Fax: (613) 247-7856

Wood Trusses

**Cariboo Lumber Manufacturers Association
(CLMA)**

205, 197 Second Avenue North
Williams Lake, BC V2G 1Z5
Telephone: (604) 392-7778
Fax: (604) 392-4692

Lumber

**Central Forest Products Association, Inc.
(CFPA)**

P.O. Box 1169
Hudson Bay, SK S0E 0Y0
Telephone: (306) 865-2595
Fax: (306) 865-3302

Lumber

**Council of Forest Industries of
British Columbia (COFI)**

1200, 555 Burrard Street
Vancouver, BC V7X 1S7
Telephone: (604) 684-0211
Fax: (604) 687-4930

Lumber, Consumer Information

Forintek Canada Corp. (FCC)

Head Office, Western Laboratory
2665 East Mall, UBC
Vancouver, BC V6T 1W5
Telephone: (604) 222-5702
Fax: (604) 222-5703

Forest Products Research Laboratory

Forintek Canada Corp. (FCC)

Eastern Laboratory
319 rue Franquet
Sainte Foy, QC G1P 4R4
Telephone: (418) 659-2647
Fax: (418) 659-2922

Forest Products Research Laboratory

APPENDIX

Information Sources continued

Forintek Canada Corp. (FCC)

Fire Research Center
 Carleton Technology Training Centre
 4100, 1125 Colonel By Drive
 Ottawa, ON K1S 5R1
 Telephone: (613) 523-0288
 Fax: (613) 523-0502

*Fire Research, Fire Performance of
 Wood Products*

Gypsum Manufacturers Association of Canada

1052 Johnathan Drive
 Mississauga, ON L4Y 1K1
 Telephone: (905) 897-2624
 Fax: (905) 897-2624

*Gypsum Building Products
 Consumer Information*

Inchcape Testing Services – Warnock Hersey

3210 American Drive
 Mississauga, ON L4V 1B3
 Telephone: (905) 678-7820
 Fax: (905) 678-7131

Fire Testing

Interior Lumber Manufacturers Association (ILMA)

360, 1855 Kirschner Road
 Kelowna, BC V1Y 4N7
 Telephone: (604) 860-9663
 Fax: (604) 860-0009

Lumber

**Maritime Lumber Bureau (MLB)
 (Bureau du bois de sciage des Maritimes)**

P.O. Box 459
 Amherst, NS B4H 4A1
 Telephone: (902) 667-3889
 Fax: (902) 667-0401

Lumber

National Fire Laboratory (NFL)

c/o National Research Council of Canada
 Montreal Road
 Ottawa, ON K1A 0R6
 Telephone: (613) 993-2204
 Fax: (613) 954-0483

Fire Research, Fire Modelling

National Lumber Grades Authority (NLGA)

103, 4400 Dominion Street
 Burnaby, BC V5G 4G3
 Telephone: (604) 451-7323
 Fax: (604) 451-7388

Lumber Grading

Northern Forest Products Association (NFPA)

400-1488 Fourth Avenue
 Prince George, BC V2L 4Y2
 Telephone: (604) 564-5136
 Fax: (604) 564-3588

Lumber

Ontario Lumber Manufacturers Association (OLMA)

**(Association des manufacturiers de bois
 de sciage de l'Ontario)**

1105, 55 University Avenue
 P.O. Box 8
 Toronto, ON M5J 2H7
 Telephone: (416) 367-9717
 Fax: (416) 367-3415

Lumber

**Structural Board Association (SBA)
 (Association de panneau structural)**

412, 45 Sheppard Avenue East
 Willowdale, ON M2N 5W9
 Telephone: (416) 730-9090
 Fax: (416) 730-9013

OSB, Waferboard

Truss Plate Institute of Canada (TPIC)

c/o GangNail Canada Inc.
 P.O. Box 1329
 Bradford, ON L3Z 2B7
 Telephone: (905) 775-5337
 Fax: (905) 775-9698

Truss Plates, Trusses

APPENDIX

Information Sources continued**Underwriters' Laboratories of Canada (ULC)**

7 Crouse Road
 Scarborough, ON M1R 3A9
 Telephone: (416) 757-3611
 Fax: (416) 757-9540

*Fire Test Standards
 Fire Protection Equipment
 Product standards and certification,
 Fire Testing*

Western Wood Truss Association (WWTA)

8428, 213 Street
 Langley, BC V1M 2J1
 Telephone: (604) 888-7905
 Fax: (604) 888-7905

Wood Trusses

UNITED STATES**American Hardboard Association**

1210 West NW Highway
 Palatine, IL 60067
 Telephone: (708) 934-8800
 Fax: (708) 934-8803

Hardboard

American Institute of Timber Construction (AITC)

140, 7012 S Revere Parkway
 Englewood, CO 80112
 Telephone: (303) 792-9559
 Fax: (303) 792-0669

Glulam

American Society for Testing and Materials (ASTM)

100 Barr Harbor Drive
 West Conshohocken, PA 19428-2959
 Telephone: (610) 832-9500
 Fax: (610) 832-9555

Material Standards, Fire Test Standards

American Wood Council (AWC)

800, 1111 – 19th Street NW
 Washington, DC 20036
 Telephone: (202) 463-2769
 Fax: (202) 463-2791

*Wood Products: Consumer Information
 Wood Engineering, Codes and Standards*

APA The Engineered Wood Association

7011 South 19th Street
 Tacoma, WA 98411
 Telephone: (206) 565-6600
 Fax: (206) 565-7265

*Plywood, OSB, Waferboard,
 Structural-Panels, Glulam*

Building Officials and Code Administrators International, Inc. (BOCA)

4051 West Flossmoor Road
 Country Club Hills, IL 60478
 Telephone: (708) 799-2300
 Fax: (708) 799-4981

Building Code Development

California Redwood Association

200, 405 Enfrente Dr.
 Novato, CA 94949
 Telephone: (415) 382-0662
 Fax: (415) 382-8531

Redwood Lumber Products

Cedar Shake & Shingle Bureau

275, 515-116th Street NE
 Bellevue, WA 98004
 Telephone: (206) 453-1323
 Fax: (206) 455-1314

Shingles & Shakes

Council of American Building Officials (CABO)

5203 Leesburg Pike, Suite 708
 Falls Church, VA 22041
 Telephone: (703) 931-4533
 Fax: (703) 379-1546

Represents Building Officials

Factory Mutual Research Corporation

1151 Boston Providence Turnpike
 Norwood, MA 02062
 Telephone: (617) 762-4300
 Fax: (617) 762-9375

*Fire Protection Systems,
 Fire Testing*

APPENDIX

Information Sources continued

Forest Products Laboratory (FPL)

One Gifford Pinchot Drive
Madison, WI 53705-2398
Telephone: (608) 231-9200
Fax: (608) 231-9592

Forest Products Research Laboratory

Gypsum Association

510, 810 First Street, N.E.
Washington, DC 20002
Telephone (202) 289-5440
Fax (202) 289-3707

*Gypsum Building Products,
Consumer Information*

Hardwood Plywood & Veneer Association (HPVA)

P.O. Box 2789
Reston, VA 22090
Telephone: (703) 435-2900
Fax: (703) 435-2537

Hardwood Plywood and Veneers

International Conference of Building Officials (ICBO)

5360 Workman Mill Road
Whittier, CA 90601
Telephone: (310) 699-0541
Fax: (310) 908-5524

Building Code Development

National Association of Home Builders (NAHB)

15th & M St. NW
Washington, DC 20005
Telephone: (202) 822-0200
Fax: (202) 822-0374

Residential Building

National Fire Protection Association (NFPA)

1 Batterymarch Park
Quincy, MA 02269
Telephone: (617) 770-3000
Fax: (617) 770-0200

*Fire Standards,
Sprinkler Standards, Fire safety
Codes and Standards*

National Institute of Building Sciences (NIBS)

400, 1201 L Street NW
Washington, DC 20005
Telephone: (202) 289-7800
Fax: (202) 289-1092

Building Regulations and Technology

National Institute of Standards and Technology (NIST)

Building and Fire Research Laboratory
Gaithersburg, MD 20899
Telephone: (301) 975-5900
Fax: (301) 975-4032

Fire Research, Fire Modelling

National Particleboard Association

18928 Premiere Court
Gaithersburg, MD 20879
Telephone: (301) 670-0604
Fax: (301) 840-1252

Particleboard

Society of Fire Protection Engineers (SFPE)

One Liberty Square
Boston, MA 02109
Telephone: (617) 482-0686
Fax: (617) 482-8184

*Fire Protection Engineering,
Fire Research, Fire Modeling*

Southern Building Code Congress International (SBCCI)

900 Montclair Road
Birmingham, AL 35213
Telephone: (205) 591-1853
Fax: (205) 592-7001

Building Code Development

Underwriters' Laboratories Inc. (UL)

333 Pfingsten Road
Northbrook, IL 60062
Telephone: (708) 272-8800
Fax: (708) 272-8129

Fire Test Standards, Fire Testing

APPENDIX

APPENDIX

Index of Tables and Figures

TABLES

Table 1.1 NBCC Standing Committee on Fire Protection	17	Table 6.4 Additional interior finish requirements for high buildings regulated by Subsection 3.2.6.	212
Table 2.1 Minimum dimensions of wood elements in heavy timber construction	33	Table 7.1 Construction of exterior walls	239
Table 2.2 Permitted uses of heavy timber construction in or as an alternative to noncombustible construction	40	Table 8.1 Egress in floor area not sprinklered throughout	284
Table 4.1 Classification of buildings	74	Table 8.2 Egress in floor area sprinklered throughout	284
Table 4.2 Fire separation required between major occupancies	84		
Table 4.3 Mandatory sprinklers in the 1995 NBCC	91	FIGURES	
Table 5.1 Restrictions on temperature rise and glazing for closures	140	Chapter 1 Lead Photograph Canadian building regulations provide for extensive wood structures	2
Table 5.2 Time assigned to wallboard membranes	159	Figure 1.1 The Boston Fire in 1872 was one of several major city fires that identified the need for new fire regulations	3
Table 5.3 Time assigned for contribution of wood or light steel frame	160	Figure 1.2 National Building Code of Canada, 1941, 1953, 1995	5
Table 5.4 Flooring or roofing over wood, cold formed steel members or open-web steel joists	162	Figure 1.3 Fire claimed 492 lives at Boston's Cocoanut Grove in the fall of 1942. It had a significant impact on regulations for exits and interior finishes.	9
Table 5.5 Fire-resistance rating for ceiling membranes	162	Figure 1.4 A fire on the ground floor of Chicago's 22-storey LaSalle Hotel, considered to be a "fire-resistive" building, sent hot gases through the ventilation system to the upper floors, forcing evacuation.	11
Table 5.6 Fire severity based on fire load concept	176	Figure 1.5 A welder's torch ignited combustible insulation material in the basement of the highrise CIL House, Montreal in 1962	12
Table 6.1 Assigned flame-spread ratings and smoke developed classifications	205	Figure 1.6 Recent fires continue to emphasize the fire hazards of high-rise structures	15
Table 6.2 Typical flame-spread ratings and smoke developed classifications of wood products	206	Chapter 2 Lead Photograph Many varieties of wood components create structural forms	28
Table 6.3 NBCC requirements for interior finish and exterior glazing	211	Figure 2.1 Steel loses strength at elevated temperatures	30

APPENDIX

Index of Tables and Figures continued

Figure 2.2 Wood-frame construction	31	Figure 4.5 Artificially raised grade	78
Figure 2.3 Heavy timber construction	32	Figure 4.6 Mezzanines and building heights	78
Figure 2.4 Heavy timber connections	34	Figure 4.7 Multiple levels of mezzanine	79
Figure 2.5 Connection details	35	Figure 4.8 Office is a subsidiary occupancy to the warehouse	80
Figure 2.6 Detail I Built-up truss joint	36	Figure 4.9 Multiple occupancy	82
Figure 2.7 Floor decks	36	Figure 4.10 Fire-resistance rating of supporting assemblies	86
Figure 2.8 Wood frame exterior wall in noncombustible construction	42	Figure 4.11 Four-storey wood-frame construction	92
Figure 2.9 Wood stud framing in exterior wall of noncombustible building	43	Figure 4.12 Impact of sprinkler changes	93
Figure 2.10 Raised wood floor	44	Chapter 5 Lead Photograph Wall assembly being removed from the furnace after a fire-resistance test	130
Chapter 3 Lead Photograph Business and medium hazard industrial complex in wood	50	Figure 5.1 Large multi-unit buildings are divided by rated fire separations to create fire compartments	133
Figure 3.1 NFPA Fire Safety Concepts Tree	53	Figure 5.2A Continuity of vertical fire separations	136
Figure 3.2 Post-fire interior	57	Figure 5.2B Continuity of vertical fire separations	136
Figure 3.3 Fire safety requirements must be addressed early in the design stages	61	Figure 5.3 Vertical shafts	137
Figure 3.4 Firefighter and the aftermath	63	Figure 5.4 Wood joists in noncombustible fire separations	143
Chapter 4 Lead Photograph Thompson Community Centre, Richmond B.C	70	Figure 5.5 Fire wall connection details	143
Figure 4.1 Heavy timber skeleton of an arena	73	Figure 5.6 Erection of trusses onto a firewall	144
Figure 4.2 Determining building area	75	Figure 5.7 Firewall support	145
Figure 4.3 Determining grade	76	Figure 5.8 Fire test furnace for floors and roofs	148
Figure 4.4 Determining number of storeys	77	Figure 5.9 Fire test furnace for walls	148

APPENDIX

Index of Tables and Figures continued

Figure 5.10 Fire test furnace for columns	150	Chapter 6 Lead Photograph In Group A, Division 2 occupancies wall and ceiling finishes with a Flame-Spread Rating of up to 150 are permitted	198
Figure 5.11 Listed wood joist floor assembly	154	Figure 6.1 The Steiner tunnel for measuring surface burning characteristics	201
Figure 5.12 Listed wood stud wall assembly	155	Figure 6.2 FRTW label	213
Figure 5.13 Load factor for glulam fire-resistance calculations (NBCC, 1995)	169	Figure 6.3 Loading wood into fire-retardant treatment pressure cylinder	215
Figure 5.14 Glulam exposure cases (NBCC Appendix D, 1995)	170	Figure 6.4 FRTW roof assembly alternative	217
Figure 5.15 Harmathy's ten rules of fire endurance	174	Figure 6.5 Fire-retardant treated wood roof systems	218
Figure 5.16 Ingberg's hypothesis on equal fire severities	175	Figure 6.6 Test apparatus for roof covering materials	220
Figure 5.17 Fire separations in residential occupancies	179	Figure 6.7 Wood shingle roof	221
Figure 5.18 Continuity of separations	180	Chapter 7 Lead Photograph The proximity of buildings is controlled to reduce potential for conflagrations	226
Figure 5.19 Mixed construction: wood trusses on heavy timbers on steel columns	181	Figure 7.1 Spatial separation determines both wall construction and amount of openings	229
Figure 5.20 Exceptions for exterior unprotected members	183	Figure 7.2 Limiting Distance	233
Figure 5.21 Typical atriums and exits	186	Figure 7.3 Limiting distance and recessed opening	236
Figure 5.22 Wood-frame fire stopping	190	Figure 7.4 Compartmentation and exposing building face	237
Figure 5.23 Wood-frame fire stopping	191	Figure 7.5 Walls as unprotected openings	239
Figure 5.24 Furring as fire stopping	191	Figure 7.6 Limiting distance for exterior structural members	241
Figure 5.25 Stair fire stopping	191	Figure 7.7 Unlimited unprotected openings at street level	243
Figure 5.26 Plywood as attic fire stopping	192		
Figure 5.27 Sprinklers allow for use of heavy timber roof assemblies in large noncombustible buildings	193		

APPENDIX

Index of Tables and Figures continued

Figure 7.8 Separation of openings in exterior walls	246	Figure 8.10 Horizontal service spaces	298
Figure 7.9 Protection of soffits	247	Chapter 9 Lead Photograph Access routes for firefighters provide a means for firefighting apparatus to be placed near hydrants and near buildings for evacuation purposes	302
Figure 7.10 Separation of window openings and skylights	248	Figure 9.1 Typical exterior standpipe and sprinkler connections	305
Figure 7.11 Limiting Distances - Examples 7.1 and 7.2	253	Figure 9.2 Building access	306
Figure 7.12 Limiting Distances - Examples 7.3 and 7.4	257	Figure 9.3 Typical sprinkler system	312
Figure 7.13 Limiting Distances - Example 7.3 Option W7.3B	259	Figure 9.4 Sprinkler system controls require periodic verification	313
Figure 7.14 Limiting Distances - Example 7.3 Option W7.3C and N7.3C	261	Figure 9.5 Firefighting equipment (R to L): firefighters' telephone, standpipe and hose cabinet with 38 and 64mm connections, portable fire extinguisher, manual alarm and fire exit	314
Chapter 8 Lead Photograph The NBCC specifies exit requirements	266	Chapter 10 Lead Photograph High-rise buildings present special fire safety hazards	320
Figure 8.1 Number and characteristics of occupants determine design standards	270	Figure 10.1 Smoke hazards present increased risk in high buildings	323
Figure 8.2 Smoke detectors	278	Figure 10.2 Stack effect	324
Figure 8.3 Typical access for floor areas	282	Figure 10.3 Firefighters' control panel	326
Figure 8.4 Corridors and classroom doorways provide access to exit	283		
Figure 8.5 Undivided floor area	285		
Figure 8.6 Public corridor divided from floor area by rated fire separations	286		
Figure 8.7 Public corridor not divided from floor area by rated fire separations	291		
Figure 8.8 Fixed seating restricts access to exits	294		
Figure 8.9 Vertical service spaces	297		

APPENDIX

Bibliography

1. Baird, Donal M., Montreal High-Rise Fire, NFPA Quarterly, Vol. LVII, National Fire Protection Association, Boston, MA, 1963.
2. Baird, Donal M., *The Story of Firefighting in Canada*, Boston Mills Press, Erin, Ontario, 1986.
3. *Building the Future — The Strategic Plan of the Canadian Commission on Building and Fire Codes 1995 – 2000*, National Research Council of Canada, Ottawa, 1996.
4. Browne, F.L., Rep. No. 2135, USDA Forest Services, Forest Product Lab., Madison, WI, 1958.
5. Castino, G.T. and Harmathy, T.Z., eds., *Fire Risk Assessment*, American Society for Testing and Materials, Special Technical Publication 762, Philadelphia, PA, 1980.
6. *CCBFC Policies and Procedures 1992*, National Research Council of Canada, Ottawa NRCC No. 34136, 1992.
7. Cote A.E. and Linville, J.L., eds., *Fire Protection Handbook*, 17th Edition, National Fire Protection Association, Quincy, MA, 1991.
8. Cote, Ron., ed., *Life Safety Code Handbook*, Sixth Edition, National Fire Protection Association, Quincy, MA, 1994.
9. *Criteria for Use in Extension of Data from Fire Endurance Tests*, ULC Subject C263(e)-M1988, Underwriters' Laboratories of Canada, Toronto, Ontario, 1988.
10. di Nenno, P.J., et al, eds., *SFPE Handbook of Fire Protection Engineering*, 2nd Edition, National Fire Protection Association, Quincy, MA, 1994.
11. Drysdale, D., *An Introduction to Fire Dynamics*, John Wiley and Sons Ltd., 1985.
12. *Engineering Design in Wood (Limit States Design) CAN/CSA-O86.1-M94*, Canadian Standards Association, Toronto, Ontario, 1989.
13. Ferguson, R.S., *Principles of Fire Protection Applied in Part 3: Use and Occupancy*, National Building Code of Canada, Technical Paper No. 272, Division of Building Research, National Research Council of Canada, Ottawa, NRCC 10054, 1970.
14. *Certification Listings*, Inchcape Testing Services – Warnock Hersey Listing Services, Mississauga, Ontario, 1995.
15. *Fire Resistance Design Manual*, GA-600-92, Gypsum Association, Thirteenth Edition, Washington, DC, 1992.
16. *Fire Resistance Directory*, Underwriters' Laboratories Inc., Volumes I and II, Northbrook, IL, 1994.
17. *FM Approval Guide*, Factory Mutual Corporation, Norwood, MA, 1996.
18. Fowell, Andrew J., ed., *Fire and Flammability of Furnishings and Contents of Buildings*, American Society for Testing and Materials, Special Technical Publication 1233, Philadelphia, PA, 1994.
19. Galbreath, M., *Fire Endurance of Light Framed and Miscellaneous Assemblies*, Technical Paper No. 222, Division of Building Research, National Research Council of Canada, Ottawa, NRCC 9085, 1966.
20. Galbreath, M., *Fire in High Buildings*, Division of Building Research, Fire Study No. 21, National Research Council of Canada, Ottawa, NRCC 10081, 1968.
21. Gosselin, G.C., *Fire Compartmentation and Fire Resistance*, Proceedings of Building Science Insight '87, Institute for Research in Construction, National Research Council of Canada, Ottawa, NRCC 28277, 1987.
22. *Guidelines for Application of Part 3 of the National Building Code of Canada to Existing Buildings*, Canadian Commission on Building and Fire Codes, National Research Council of Canada, Ottawa, NRCC 35951, 1993.
23. *Guideline on Fire Ratings of Archaic Materials and Assemblies*, Rehabilitation Guideline #8, U.S. Department of Housing and Urban Development, Germantown, MD, 1980.
24. *Gypsum Board*, CSA A82.27-M1977, Canadian Standards Association, Toronto Ontario, 1977.
25. *Gypsum Board*, CSA A82.27-M91, Canadian Standards Association, Toronto, Ontario, 1991.

APPENDIX

Bibliography continued

26. Hansen, A.T., *The Regulation of Building Construction*, Canadian Building Digest 237, National Research Council of Canada, Ottawa, 1985.
27. Harmathy, T.Z., ed., *Fire Safety Science and Engineering*, American Society for Testing and Materials, Special Technical Publication 882, Philadelphia, PA, 1985.
28. Harmathy, T.Z., *Fire Test of a Wood Partition*, Division of Building Research, Fire Study No. 3, National Research Council of Canada, Ottawa, NRCC 5769, 1960.
29. Harmathy, T.Z., *A New Look at Compartment Fires Part I and II*, NFPA Fire Technology, Volume 8, Nos. 3 and 4, National Fire Protection Association, Boston, MA, 1972.
30. Harmathy, T.Z., *Ten Rules of Fire Endurance Ratings*, Fire Technology, Vol. 1, No. 2, National Fire Protection Association, Boston, MA, 1965.
31. *High-Rise Building Fires and Fire Safety*, Reprints from Fire Journal and Fire Technology, NFPA No. SPP-18, National Fire Protection Association, Boston, MA, 1972.
32. Hirschler, Marcelo M., ed., *Fire Hazard and Fire Risk Assessment*, American Society for Testing and Materials, Special Technical Publication 1150, Philadelphia, PA, 1992.
33. Ingberg, S.H., *Test of the Severity of Building Fires*, NFPA Quarterly, Volume 22, No. 1, National Fire Protection Association, Boston, MA, 1928.
34. Lie, T.T., *A Method for Assessing the Fire Resistance of Laminated Timber Beams and Columns*, Canadian Journal of Civil Engineering, Vol. 4, No. 2, 1977.
35. *List of Equipment and Materials, Volume II Building Construction*, Underwriters' Laboratories of Canada, Scarborough, Ontario, 1993.
36. Lyons, Paul Robert, *Fire in America*, National Fire Protection Association, Boston, MA, 1976.
37. McGuire, J.H., *Fire and Spatial Separation of Buildings*, Technical Paper No. 212, Division of Building Research, National Research Council of Canada, Ottawa, Ontario, NRCC 8901, 1966.
38. McGuire, J.H. and Williams-Leir, G., *Fire and the Spatial Separations of Buildings*, Technical Paper No. 380, Division of Building Research, National Research Council of Canada, Ottawa, NRCC 12879, 1972.
39. Mehaffey, J.R., *Combustibility of Building Materials*, Proceedings of Building Science Insight '87, Institute for Research in Construction, National Research Council of Canada, Ottawa, NRCC 28277, 1987.
40. Mehaffey, J.R., *Flammability of Building Materials and Fire Growth*, Proceedings of Building Science Insight '87, Institute for Research in Construction, National Research Council of Canada, Ottawa, NRCC 28277, 1987.
41. Mehaffey, J.R., ed., *Mathematical Modeling of Fires*, American Society for Testing and Materials, Special Technical Publication 983, Philadelphia, PA, 1988.
42. *National Fire Code of Canada*, Canadian Commission on Building and Fire Codes, National Research Council of Canada, Ottawa, NRCC No. 38727, 1995.
43. *Objective Based Codes: A New Approach For Canada*, National Research Council of Canada, Ottawa, 1996.
44. Olesziewicz, Igor, *The Concept and Practice of Performance Based Building Regulations*, Internal Report No. 697, National Research Council of Canada, Ottawa, 1994.
45. Phillips, D., and Kasem, M.A., *Upholstered Furniture Fires in Canada*, Consumer and Corporate Affairs Canada, L10127-F32, 1985.
46. Powers, Robert W., *Sprinkler Experience in High Rise Buildings (1969-1979)*, SFPE Technology Report 79-1, Society of Fire Protection Engineers, Boston, MA, 1979.

APPENDIX

Bibliography continued

47. Proulx, Guylene, et al, *Study of the Occupant's Behaviour During the 2 Forest Laneway Fire in North York, Ontario, January 6th, 1995.*, Internal Report IRC-IR-705, Institute for Research and Construction, National Research Council of Council, Ottawa, 1995.
48. Puchovsky, Milosh T., et al, *NFPA's Future in Performance-Based Codes and Standards*, National Fire Protection Association, Quincy, MA, 1995.
49. *Registry of Product Evaluations*, Canadian Construction Materials Centre, National Research Council of Canada, Ottawa, NRCC No. 36130, Winter 1995 – 1996.
50. Richardson, J.K., *An Assessment of the Performance of Automatic Sprinkler Systems*, SFPE Technology Report 84-2, Society of Fire Protection Engineers, Boston, MA, 1984.
51. Robertson, A.F. ed., *Fire Standards and Safety*, American Society for Testing and Materials, Special Technical Publication 614, Philadelphia, PA, 1976.
52. Schaffer, E.L., *Charring Rates of Selected Woods Transverse to Grain*, Res. Pap. FPL 69, USDA Forest Service, Forest Products Lab., Madison, WI, 1967.
53. Schaffer, E.L., *Review of Information Related to the Charring Rate of Wood*, Res. Note FPL-145, USDA Forest Service, Forest Products Lab., Madison, WI, 1966.
54. Schaffer, E.L., et al, *Strength Validation and Fire Endurance of Glue-Laminated Timber Beams*, Res. Pap. FPL 467, USDA Forest Service, Forest Products Lab., Madison, WI, 1986.
55. Shorter, G.W., McGuire, J.H., N.B. Hutcheon, and Leggett, R.F., *The St. Lawrence Burns*, NFPA Quarterly, Vol. 53, No. 4, National Fire Protection Association, Boston, MA, 1960.
56. Shoub, H., ed., *Early History of Fire Endurance Testing in the United States*, American Society for Testing and Materials, Special Technical Publication 301, Philadelphia, PA, 1961.
57. Smith, J. Grove, *Fire Waste in Canada*, Report of the Commission of Conservation, Ottawa, 1918.
58. Solomon, R.E. ed., *Automatic Sprinkler Systems Handbook*, Sixth Edition, National Fire Protection Association, Quincy, MA, 1994.
59. *Standard for Fire Doors and Windows*, NFPA 80, National Fire Protection Association, Quincy, MA, 1992.
60. *Standard for the Installation, Maintenance and Use of Protective Signaling Systems*, NFPA 72, National Fire Protection Association, Quincy, MA, 1990.
61. *Standard for the Installation of Sprinkler Systems*, NFPA 13, National Fire Protection Association, Quincy, MA, 1994.
62. *Standard for the Installation of Sprinkler Systems in One-and Two-Family Dwellings and Mobile Homes*, NFPA 13D, National Fire Protection Association, Quincy, MA, 1994.
63. *Standard for the Installation of Sprinkler Systems in Residential Occupancies up to Four Storeys*, NFPA 13R, National Fire Protection Association, Quincy, MA, 1994.
64. *Standard for the Installation of Standpipe and Hose Systems*, NFPA 14, National Fire Protection Association, Quincy, MA, 1993.
65. *Standard for the Installation of Fire Alarm Systems*, Underwriters' Laboratories of Canada, ULC Standard CAN/ULC S524-M91, Scarborough, Ontario, 1991.
66. *Standard for the Verification of Fire Alarm Systems*, Underwriters' Laboratories of Canada, ULC Standard CAN/ULC S537-M87, Scarborough, Ontario, 1986.
67. *Standard Method for Accelerated Weathering of Fire-Retardant Treated Wood for Fire Testing*, ASTM D2898, American Society for Testing and Materials, Philadelphia, PA, 1994.
68. *Standard Methods of Fire Endurance Tests of Building Construction and Materials*, Underwriters' Laboratories of Canada, ULC Standard CAN4-S101-M89, Scarborough, Ontario, 1982.
69. *Standard Method of Fire Tests for Fire Stop Systems*, Underwriters' Laboratories of Canada, ULC Standard CAN4-S115-M85, Scarborough, Ontario, 1985.

APPENDIX

Bibliography continued

70. *Standard Method of Fire Test of Exterior Wall Assemblies*, Underwriters' Laboratories of Canada, ULC Standard CAN/ULC-S134-M92, Scarborough, Ontario, 1992.
71. *Standard Method of Fire Tests of Light Diffusers and Lenses*, Underwriters' Laboratories of Canada, ULC Standard ULC-S102.3-M1982, Scarborough, Ontario, 1982.
72. *Standard Methods of Fire Tests of Roof Coverings*, Underwriters' Laboratories of Canada, ULC Standard CAN/ULC-S107-M87, Scarborough, Ontario, 1987.
73. *Standard Method of Test for Determination of Degrees of Combustibility of Building Materials Using an Oxygen Consumption Calorimeter (Cone Calorimeter)*, Underwriters' Laboratories of Canada, ULC Standard CAN/ULC-S135-92, Scarborough, Ontario, 1992.
74. *Standard Method of Test for Determination of Non-Combustibility in Building Materials*, Underwriters' Laboratories of Canada, ULC Standard CAN4-S114-M80, Scarborough, Ontario, 1980.
75. *Standard Method of Test for Fire Spread Under Roof-Deck Assemblies*, Underwriters' Laboratories of Canada, ULC Standard CAN/ULC-S126-M86, Scarborough, Ontario, 1986.
76. *Standard Method of Test for Surface Burning Characteristics of Building Materials and Assemblies*, Underwriters' Laboratories of Canada, ULC Standard CAN/ULC-S102-M88, Scarborough, Ontario, 1988.
77. *Standard Method of Test for Surface Burning Characteristics of Flooring, Floor Covering, and Miscellaneous Materials and Assemblies*, Underwriters' Laboratories of Canada, ULC Standard CAN/ULC-S102.2-M88, Scarborough, Ontario, 1988.
78. *Standard Test Methods for Fire Tests of Building Construction and Materials*, ASTM E119-95, American Society for Testing and Materials, Philadelphia, PA, 1995.
79. *Supplement to the National Building Code of Canada 1990*, Associate Committee on the National Building Code, National Research Council of Canada, Ottawa, NRCC 30629, 1990.
80. *Test Methods for Electrical Wires and Cables*, CSA C22.2 No. 0.3-92, Canadian Standards Association, Toronto, Ontario, 1992.
81. *Thermal Insulation, Mineral Fibre, for Buildings*, CSA A101-M1983, Canadian Standards Association, Toronto, Ontario, 1983.
82. U.S. Department of Energy, *Automatic Sprinkler System Performance and Reliability in United States Department of Energy Facilities*, 1952-1980, Washington, DC, 1982.
83. *Users Guide – NBCC 1995 Fire Protection, Occupant Safety and Accessibility (Part3)*, Canadian Commission on Building and Fire Codes, National Research Council of Canada, Ottawa, 1996.
84. Walker, John, *Disasters*, Studio Vista, London, 1973.
85. Williams-Leir, G., *Program for Pocket Calculator to Derive Spatial Separations to Deter Fire Spread*, Computer Program No. 44, Division of Building Research, National Research Council of Canada, Ottawa, 1978.
86. Williams-Leir, G., *Another Approximation for Spatial Separation*, Technical Paper No. 372, Division of Building Research, National Research Council of Canada, Ottawa, NRCC 12643, 1970.
87. Williams-Leir, G., *Approximation for Spatial Separations*, NFPA Fire Technology Volume 2, No. 2, National Fire Protection Association, Boston, MA, 1966.
88. *Wood Building Technology*, Canadian Wood Council, Ottawa, 1993
89. *Wood Design Manual*, Canadian Wood Council, Ottawa, 1995.
90. *Wood Preservation*, CAN/CSA O80 Series M89, Canadian Standards Association, Toronto, Ontario, 1989.
91. *Wood Reference Handbook*, Canadian Wood Council, Ottawa, 1995.

APPENDIX

Index

A

Access for fire fighting	
<i>See</i> firefighting	
Access panels	308-309
Access routes	305-307
Access to exits	282-287
Alarm systems	
control facility	327
in suites	281
<i>See also</i> Fire alarms; Fire detection systems	
American Society for Testing and Materials (ASTM)	
standard re. roof assemblies	222
and testing fire-resistance ratings	147
American Society for Testing Materials (ASTM) Standards	
(D-2898) accelerated weathering test	214, 222
(E-108) roof coverings	222
(E-119) fire-resistance ratings	155
(E-84) flame-spread rating	204
Annunciator panels	275-276, 280
Arenas	77, 80
Assembly occupancies. <i>See</i> Group A occupancies (assembly)	
ASTM. <i>See</i> American Society for Testing Materials (ASTM)	
Atriums	
requirements for	131, 185-187
<i>Automatic Sprinkler Systems Handbook</i> (NFPA)	316
B	
Basements	
<i>See</i> Access for firefighting, below grade; Storeys below ground	
Beams	177
Beams, glulam	168-171
<i>See also</i> Heavy timber construction	
Bleachers	74

Building

definition	71
classification	73-82
construction requirements	83
<i>See also</i> Design requirement tables	
size	
building area	75
building height	76-80
exceptions for building height	77-80
major occupancy	80-81
<i>See also</i> Group A, B, C, etc. occupancies	
Building codes	
fires that shaped	9-15
origin of	3-5
<i>See also</i> <i>National Building Code of Canada</i>	
Burning brands	220, 222
Burn rate. <i>See</i> Char	
Business and personal services occupancies.	
<i>See</i> Group D occupancies	
C	
Cables	142, 297, 327
Canadian Commission on Building and Fire Codes	
formation of	17-18
Public Review Process	19
role of	6, 13
Standing Committee on Fire Protection	18
Canadian Construction Materials Centre (CCMC)	23
Canadian Standards Association (CSA)	
heavy timber construction	34
wood-frame construction	32
Canadian Standards Association (CSA) Standards	
(0141) <i>Softwood Lumber</i>	34
(080) <i>Wood Preservation</i>	213
(086) <i>Engineering Design in Wood</i>	32, 169
Canadian Wood Council, <i>Wood Design Manual</i>	32, 169

APPENDIX

Index continued

Care and detention occupancies. See Group B occupancies (care and detention)	
CCMC. See Canadian Construction Materials Centre (CCMC)	
Ceiling membranes	
fire-resistance rating	135
component additive method	161-163
Ceilings, basis for fire-resistance rating	157
Ceiling spaces	298
Cellulose	167, 203
Cement board, reinforced	202
Central alarm and control facility	327
Char	33, 168
Cladding and fascias	42-44
Closures	
compartmentation	62
protection of openings	135-140
Coatings, as interior finishes	207
Columns, fire-resistance rating	250, 179
Columns, glulam	168-171
Combustible construction	
fire-resistance rating	177
Compartmentation	
affect on fire severity	175-176
area of exposing building face	237-238
containing a fire	61-63
definition	133
exposure protection within a building	245-250
See also Fire separations	
Component additive method	157-165
Concealed spaces	
combustible materials in	39, 59, 199, 297
fire separations	146, 189
fire stopping	39, 104, 163, 189-192
sprinklers	313, 315
Concrete construction	144
Concrete, reinforced	29, 144
Connections	
fire service	305, 307
heavy timber construction	34-37
joists for firewalls	145
Construction requirements	83-89
See also Design Requirement Tables	
Construction types	98
heavy timber construction	33-38
noncombustible construction	39-47
wood frame construction	31-32, 55-59
Corridors	282, 286-287
Crawl spaces	95-96
See also Storeys below ground	
D	
Dampers	141
Design requirement tables	97-127
Division of Building Research. See Institute for Research in Construction (IRC)	
Doors	
fire-resistance rating	138-139
flame-spread rating	210-211
See also Closures; Egress, means of; Exits	
Draft stops	186, 277
Dry pipe systems	315
Ducts	13, 58, 135, 141, 163, 297
firewalls	274
Dwelling units	178, 210, 246, 273, 279, 293
E	
Eave projections	146, 192, 240
Egress, means of	
access to exits	282-287
exits	287-292
floor areas of specific occupancies	293-297
suites	281-282
Electrical conductors, in high buildings	327
Electrical wiring	141-142
Elevators	
firefighters'	326
high buildings	326
Emergency power supply, in high buildings	328
Equivalent opening factor	244
See also Spatial separation	

APPENDIX

Index continued

Evacuation		Fire extinguishers, portable	317
high buildings	323	Firefighting	
managing the exposed	67, 267	access to buildings	305-309
Exhaust systems, mechanical	186	access above grade	308
Existing buildings, application of NBCC.		access below grade	309
See Upgrading		fire protection systems	
Exits		sprinklers	91, 311-316
means of egress	281-291	standpipes	316-317
occupant load	269-271	water supply	316
width of	289	high buildings	326-327
See also Egress, means of; Evacuation		elevators	326
Exposing building face		Fire growth	
area of	237-238	limiting of	55-59
construction of	238-240	flammability	58-59
fire spread between buildings	227-228	noncombustibility concept	57
limiting distance	233-235, 251-262	Fire hose. See Standpipe and hose systems	
See also Spatial separation		Fire load	175-176
Exterior walls. See Spatial separation;		Fire modelling	171-172
Walls, exterior		<i>Fire Protection Handbook</i> (NFPA)	316
Extrapolation of data from fire tests	172-174	Fire-protection ratings, closures	138
		Fire protection systems	
F		sprinkler systems	311-316
Finish, interior. See Flame-spread rating;		standpipes	316-317
Interior finish		water supply	316
Fire		Fire resistance	
containing it	61-63	and multiple occupancy	83-89
firefighting	65, 303	and sprinklers	91-93
preventing conflagrations	62-63	Fire-resistance rating	
description of in a room	55	alternative methods for determining	157-174
Fire alarms	273-280	extrapolating data from tests	172-174
and occupant load	269-271	for glulam timbers	168-171
See also Fire detection systems		Harmathy's "Ten Rules of Fire Endurance"	172-174
Fire compartments See Compartmentation		of atriums	185-187
Fire department connections. See Sprinklers;		ceiling assemblies	147-149, 157-165
Standpipe and hose system		component additive method	157-165
Fire detection systems		definition	147, 157
alarm systems	273-280	exits	290
fire and smoke detection systems	276-279	exterior walls	149-150, 160
smoke alarms	279	fire separations	133-146, 175
See also Fire alarms; Flame detectors;		firewalls	144, 158
Heat detectors; Smoke detection systems;			
Smoke alarms			

APPENDIX

Index continued

floor assemblies	147-149, 157-165		
heavy timber construction	37		
history	147		
mezzanines	185-187		
requirements in NBCC	175-183		
exceptions to	182-183		
history	175		
loadbearing structural elements	179-182		
structural assemblies	176-179		
roof assemblies	147-149, 157-165		
and sound resistance	166-168		
of supporting assemblies	87		
testing	147-153		
alternative test standards	155		
availability of test results	153		
standard temperature-versus-time curve	152		
ULC S101 test method	151		
wood-framed buildings	32-33		
Fire-resistive construction	9, 29		
Fire retardant coatings	214, 222		
Fire-retardant treated wood (FRTW)			
flame spread	213-214		
roof assemblies	217-219		
roof coverings	219-222		
Fires			
examples of ones that shaped building codes	3-4, 9-15		
Fire safety, occupant load	269-271		
Fire separations	133-146		
compartmentation	61-63		
continuity of	134-142, 180		
protection of openings by closures	135-139		
protection of small openings	141-142		
corridors	282, 286-287		
exits	290		
fire-resistance rating	133-146, 175		
firewalls	142-146		
residential occupancies	178-179		
as structural fire protection	131		
		See also	Closures; Compartmentation; Exits; Fire stops; Firewalls; Openings
Fire severity, fire load concept	175-176		
Fire stops	189-192		
Firewalls			
building area	75		
fire-resistance rating	144		
fire separations	142-146		
Flame detectors	278		
Flame-spread rating			
combustible materials	58-59		
determining	201-206		
fire-retardant treated wood	213-214		
high buildings	325		
interior finishes	207-212		
noncombustible construction	209-211		
roof assemblies	217-222		
wood finishes	205-206		
Flammability			
determining	201-206		
limits placed on	211-212		
Flashover	55		
Floor areas			
assembly occupancies	293		
care facilities	294-295		
fire compartments	237, 286		
garages	295		
major occupancy	87		
mezzanines	77-80		
residential occupancies	293-294		
service spaces	295-299		
Flooring			
flame-spread rating	208		
wood in noncombustible construction	45		
Foamed plastics			
flame-spread rating	203		
insulation	39, 58		
Framing, wood or light steel	160		
FRTW. See Fire-retardant treated wood (FRTW)			

APPENDIX

Index continued

Furnaces			
Steiner tunnel		201-203	
testing fire-resistance ratings		147-151	
Furring			
fire stopping		191	
use of wood in noncombustible construction		40-41	
Fusible links, doors in fire separations		139	
G			
Gables		240	
Garages			
firewalls		145-146	
unprotected openings		243	
Glass			
blocks		244	
and fire separations		139	
wired, area of unprotected openings		244	
Glazing, solid		77	
Glue-laminated timber beams and columns.			
See Glulam			
Glulam			
fire resistance		168-171	
See also Heavy timber construction			
Grade, building height		76-77	
Group A occupancies (assembly)			
classification		73-74	
design requirement tables		99-106	
flame-spread rating		210-211	
Group B occupancies (care and detention)			
alarm systems		274, 277	
classification		73-74	
design requirement tables		107-109	
use of wood partitions in		45	
Group C occupancies (residential)			
alarm systems		274, 277	
classification		73-74	
design requirement tables		111-113	
fire separation		178	
sprinkler systems for		312-313	
Group D occupancies (business and personal services)			
classification		73-74	
design requirement tables		114-116	
Group E occupancies (mercantile)			
classification		73-74	
design requirement tables		117-118	
fire-resistance rating		182	
Group F occupancies (industrial)			
alarm systems		274	
classification		73-74	
design requirement tables		119-127	
fire-resistance rating		182	
Gypsum board			
fire-resistance rating		150, 153, 159-160, 167	
flame-spread rating		205	
in noncombustible construction		39	
as a protective finish		32	
H			
Harmathy, Dr. Tibor, <i>"The Ten Rules of Fire Endurance"</i>			172-174
Hazardous Products Act			51
Heat detectors			276
Heavy timber construction			33-38
definition		33	
fire-resistance rating		37, 181, 194	
roofs		194	
High building			
evacuation		13-15	
firefighting		65, 326-327	
fire safety in		323-328	
flame-spread rating		325	
problems of fires in		13-15	
smoke control systems		323-325	
smoke developed classification		59, 325	
wood finishes		47	
Horizontal assemblies			147-148
Horizontal service spaces. See Ceiling spaces			

APPENDIX

Index continued

I

Increased area of openings	244
Industrial occupancies. <i>See</i> Group F occupancies (industrial)	
Institute for Research in Construction (IRC)	6, 151
Codes Centre	18-19
Insulation, and fire-resistance ratings	159, 161, 167
Interconnected floor spaces	185-187
building height	77-80
fire separations	238
<i>See also</i> Atriums; Mezzanines	
Interior finishes	207-212
application of <i>NBCC</i> requirements	209-212
fire-retardant treated wood	213-215
fire-test methods	201-204
high buildings	325
<i>See also</i> Flame-spread rating	
IRC. <i>See</i> Institute for Research in Construction (IRC)	

L

Light fixtures, flame-spread rating for	208-209
Limiting distance	233-241
examples of calculations	251-263
<i>See also</i> Spatial separation, Exposing building face	
Loadbearing structural elements	179-182

M

Major occupancy	80-82
Means of egress. <i>See</i> Egress, means of	
Mercantile occupancies. <i>See</i> Group E occupancies (mercantile)	
Mezzanines	
building height	77-80
fire protection requirements	185-18
Millwork	44

N

<i>National Building Code of Canada (NBCC)</i>	
Appendix B	
smoke control	325
Appendix D	
fire resistance	157-165, 168-171
flame-spread rating	204-206
assumptions and objectives	51-67
development	17-21
history	3-4
objective-based requirements	23-25
prescriptive requirements	23
relationship with <i>NFCC</i>	20-21
<i>National Fire Code of Canada (NFCC)</i>	20-21
National Fire Protection Association (NFPA)	6-7
<i>Automatic Sprinkler Systems Handbook</i>	316
Fire Safety Concepts Tree	52-54
National Fire Protection Association (NFPA) Standards	
(13) <i>Installation of Sprinkler Systems</i>	312-315
(13D) residential sprinkler systems	312
(13R) residential sprinkler systems	312
(14) <i>Installation of Standpipe and Hose Systems</i>	317
(255) interior finishes	204
(257) roof coverings	222
(72D) ... Proprietary Protective Signalling Systems	280
(80) <i>Standard for Fire Doors and Windows</i>	137-138
National Research Council of Canada (NRC)	6, 18
Institute for Research in Construction	151
<i>NBCC. See National Building Code of Canada (NBCC)</i>	
<i>NFCC. See National Fire Code of Canada (NFCC)</i>	

APPENDIX

Index continued

NFPA. *See* National Fire Protection Association (NFPA)

Noncombustibility

definition 39

test 56-59

Noncombustible construction

definition 55

fire-resistance rating 177

use of wood in 39-47

 cladding and fascias 42-44

 fire stops 41

 flooring elements 45

 millwork 44

 roofs 41

 stairs and storage lockers 46

 window sash and frames 41

 wood finishes 46-47

 wood furring 40-41

 wood partitions 45-46

NRC. *See* National Research Council of Canada (NRC)

O

Occupancies

construction requirements 83-89

design requirement tables for 97-127

safety within floor areas 293-295

See also Building classification; Group A, B, C, etc. occupancies

Occupancy

major

 alarm systems 273

 definition 80-82

 separation 84-86

multiple

 fire alarm systems 274

 subsidiary 81

Occupant load 269-271

Openings

 closures 135-140

 protection of small 141-142

See also Closures; Interconnected floor spaces

P

Paint. *See* Coatings

Parapets

 roofs 144-145

 wood furring 41

Partitions

 fire separations 149

 wood 45-46

Performance-based requirements 51

Pipes 141

Plastics, foamed. *See* Foamed plastics

Plywood

 fire-retardant treated 219

 fire stopping 189-192

Prescriptive requirements 51, 176

Pressurization 324-325

Prevention of fire-spread between buildings.
See Spatial separation

Proprietary control centres 280

Protected floor space 185

Provincial/Territorial Committee on Building Standards (PTCBS) 6

PTCBS. *See* Provincial/Territorial Committee on Building Standards (PTCBS)

Public corridors. *See* Corridors

R

Radiation

 adjacent buildings 227-231

 exterior walls 183

 through openings 62, 238, 244

Rehabilitation, of old buildings.
See Upgrading

Residential occupancies.
See Group C occupancies (residential)

Roof assemblies

 fire-resistance rating 157-159

 sprinklers 92-93, 194

 fire-retardant treated wood

APPENDIX

Index continued

roof systems	218-219
flame spread	217-218
roof coverings	219-222
Roof coverings. <i>See</i> Roof assemblies	
Roofs	
decking	217
firewalls	144
use of wood	41
<i>See also</i> Soffits	
Roof-top enclosures	298-299
S	
St. Lawrence Burns	227
Separations, fire. <i>See</i> Fire separations	
Service spaces	297-299
Shafts	135, 137
Shakes. <i>See</i> Roof assemblies	
Shingles. <i>See</i> Roof assemblies	
Siding. <i>See</i> Spatial separations; Walls, exterior	
Single-stage fire alarm systems	274
Smoke	
alarms	279
<i>See also</i> Fire alarms; Fire detection systems; Smoke detectors	
control in high buildings	323-325
detection systems	276-279
Smoke developed classification	
definition	59
high buildings	325
tests for interior finishes	201-203
Soffits	246-247
Sound Transmission Classification (STC)	166-168
Spatial separation	
examples of calculations	251-263
exceptions to requirements	243-244
equivalent opening factor	244
increased area of openings	244
exposure protection within a building	245-250
fire spread between buildings	227-231
limiting distance	233-241

Sprinklers	
building area	91-92
changes in the 1995 NBCC	91-93
as fire protection system	91-93, 193-194, 311-317
high buildings	323
increased area of unprotected openings	231
mezzanines and atriums	185-186
systems	311-317
travel distances	290
Stack effect	13, 59, 324
Stairs	46, 191
Standards Council of Canada	23
Standard time-versus-temperature curve	152
<i>See also</i> Fire-resistance rating	
Standpipe and hose system	305, 316-317
Steel	29-30
fire-resistance rating	182
studs, wall assemblies	158
Steiner tunnel	
testing interior finishes	201-203
testing roof assemblies	217
Storage rooms, lockers	46, 276
Storeys below ground level	95-96
Streets, construction requirements	88
Suites	281
<i>See also</i> Access to exits	
T	
Tall buildings. <i>See</i> High buildings	
Tar. <i>See</i> Roof assemblies	
Tests	
combustibility	56-58
fire alarm systems	275
fire-protection rating for closures	138
fire resistance	147-153
flame-spread rating	201-204
interior finishes	201-204
roof coverings	220-222
smoke developed classification	201-204
<i>See also</i> ASTM Standards; CSA Standards; NFPA Standards; ULC Standards	

APPENDIX

Index continued

Thermal barriers	43, 208, 218
Thermoplastic materials	204
Tiles. See Roof assemblies	
Time-temperature curve. See Standard time-versus-temperature curve	
Travel distance	285-287, 290
Two-stage fire alarm systems	274

U

ULC	
“Criteria for Use in Extension of Data from Fire Endurance Tests”	173
ULC Standards	
(CAN4, S113) <i>Standard Specification for Wood Core Doors Meeting the Performance Required...</i>	138
(CAN4-S104) <i>Standard Method for Fire Tests of Door Assemblies</i>	138
(CAN4-S115) <i>Standard Method of Test of Fire Stop Systems</i>	142
(CAN/ULC-S101) <i>Standard Method of Fire Endurance Tests of Building Construction...</i>	151-153, 327
(CAN/ULC-S102.2) <i>Standard Method of Test for Flooring, Floor Covering...</i>	203-204
(CAN/ULC-S102.3) <i>Standard Method of Fire Tests of Light Diffusers and Lenses</i>	209
(CAN/ULC-S102) <i>Standard Method of Test for Building Materials and Assemblies</i>	202-204
(CAN/ULC-S107) <i>Standard Methods of Test of Roof Coverings</i>	220, 222
(CAN/ULC-S114) <i>Standard Method of Test for Determination of Noncombustibility of Materials</i>	56
(CAN/ULC-S126) <i>Standard Method of Test for Fire Spread Under Roof-Deck Assemblies</i>	217-219
(CAN/ULC-S127)	
“The corner wall test”	204
(CAN/ULC-S134) <i>Standard Method of Fire Test of Exterior Wall Assemblies</i>	43
(CAN/ULC-S524) <i>Standard for the Installation of Fire Alarm Systems</i>	275

(CAN/ULC-S537) <i>Standard for the Verification of Fire Alarm Systems</i>	275
UL Standards, (790) roof coverings	222
Underwriters' Laboratories Inc.	
fire-test methods	201
standard re. roof assemblies	220
testing fire-resistance ratings	153
Underwriters' Laboratory of Canada. See ULC	
Unprotected openings	
equivalent opening factor	244
exposing building faces	238-239, 243
fire spread between buildings	229-231, 234-235
increased area of openings	244
See also Openings; Spatial separation	
Unsprinklered areas. See Sprinklers	
Unusual structures	317
Upgrading	
NBCC and upgrading of existing buildings	20
occupant load	269
V	
Varnish. See Coatings	
Vaults	182
Veneer	207
Venting	
and fire severity	176
high buildings	13, 324, 327
smoke detectors in air circulation system	277
Vertical service space	297-298
Vertical shafts	13, 135, 297
Vestibules	185, 324-325
Vibration control	32
Voice communication system	327
W	
Wallboard	159-160
Wallpaper. See Coatings	

APPENDIX

Index continued

Walls

exposing building faces	235, 237-240
fire-resistance rating	158, 161, 164
fire-resistance ratings	149-150, 166-168
in noncombustible buildings	42-43

Warnock Hersey Professional Services Ltd.	153
---	-----

Water supply

as fire protection system	311
for sprinkler systems	311-312

Weathering	44, 214, 222
------------	--------------

Window, sash and frames	41
-------------------------	----

Wired glass. *See* Glass

Wood

advantages of	29
flame-spread rating	204-206
in noncombustible buildings	39-47
in service spaces	296

Wood Design Manual

(Canadian Wood Council)	32, 169
-------------------------	---------

Wood finishes	46-47, 207-210
---------------	----------------

Wood-frame construction

definition	31-33
------------	-------

fire-resistance rating,

Group C occupancy buildings	179
-----------------------------	-----

loadbearing structural elements	179-180
---------------------------------	---------

fire stops	189-191
------------	---------

Wood partitions in

noncombustible buildings

Wood, structural systems in

heavy timber construction.

See Heavy timber construction

wood-frame construction.

See Wood-frame construction

APPENDIX

Index of Code References

2.1		3.1.8.10.	138
2.1.6.1.	145	3.1.8.11.	139
2.1.6.2.	76	3.1.8.12.	139
		3.1.8.15.	138
2.5		3.1.9.	134
2.5.3.1.	204, 222	3.1.9.1.	142
		3.1.9.2.	142
3.1		3.1.9.3.	142
3.1.3.1.	85	3.1.9.4.	141, 194
3.1.4.2.	208	3.1.10.	144
3.1.4.4.	46, 213	3.1.10.1.	145, 146
3.1.4.5.	37	3.1.10.2.	146
3.1.4.6.	34, 37, 38, 194	3.1.10.3.	146
3.1.5.	321	3.1.10.4.	146
3.1.5.2.	41, 58	3.1.10.5.	138, 144, 146
3.1.5.3.	41, 221	3.1.10.7.	146
3.1.5.4.	41	3.1.11.1.	189
3.1.5.5.	42-43, 44, 58, 214	3.1.11.5.	189, 194
3.1.5.6.	40	3.1.11.6.	96
3.1.5.7.	44	3.1.11.7.	189
3.1.5.8.	45, 208	3.1.12.1.	202-203, 58
3.1.5.9.	46	3.1.13.	58
3.1.5.10.	46, 209, 210	3.1.13.1.	207
3.1.5.12.	45	3.1.13.2.	46, 210, 290, 298
3.1.5.13.	46	3.1.13.4.	209
3.1.5.17.	142	3.1.13.6.	47, 210
3.1.5.19.	142	3.1.13.7.	47, 59, 208, 298, 325
3.1.7.1.	151, 157	3.1.13.8.	209-210, 214
3.1.7.2.	150, 244	3.1.14.1.	218
3.1.7.3.	147, 161, 168, 240	3.1.14.2.	218
3.1.7.4.	182	3.1.15.1.	220
3.1.7.5.	87, 179, 194	3.1.15.2.	221-222
3.1.8.1.	61-62, 134	3.1.16.1.	269-271
3.1.8.3.	135		
3.1.8.4.	137	3.2	
3.1.8.4.	138	3.2.1.1.	77, 79, 80, 297-298
3.1.8.6.	137-138, 144, 194	3.2.1.2.	95
3.1.8.7.	141	3.2.1.5.	95
3.1.8.8.	141	3.2.2.3.	182

APPENDIX

Index of Code References continued

3.2.2.5.	83	3.2.2.50.	89, 114
3.2.2.6.	82	3.2.2.51.	114
3.2.2.7.	82-83, 85-87	3.2.2.52.	115
3.2.2.8.	87	3.2.2.53.	89, 116, 177
3.2.2.9.	96	3.2.2.54.	88, 116
3.2.2.10.	305, 307	3.2.2.55.	116
3.2.2.14.	77, 299	3.2.2.56.	116
3.2.2.15.	95, 309	3.2.2.57.	83, 117
3.2.2.16.	39, 93, 194	3.2.2.58.	117
3.2.2.20.	99	3.2.2.59.	118
3.2.2.21.	100	3.2.2.60.	118
3.2.2.22.	100	3.2.2.61.	118
3.2.2.23.	101	3.2.2.62.	118
3.2.2.24.	101	3.2.2.63.	119
3.2.2.25.	102	3.2.2.64.	119
3.2.2.26.	102	3.2.2.65.	120
3.2.2.27.	103	3.2.2.66.	120
3.2.2.28.	103	3.2.2.67.	121
3.2.2.29.	104	3.2.2.68.	121
3.2.2.30.	104	3.2.2.69.	122
3.2.2.31.	104	3.2.2.70.	122
3.2.2.32.	105	3.2.2.71.	122
3.2.2.33.	105	3.2.2.72.	122
3.2.2.34.	105	3.2.2.73.	123
3.2.2.35.	106	3.2.2.74.	123
3.2.2.36.	107	3.2.2.75.	123
3.2.2.37.	107	3.2.2.76.	124
3.2.2.38.	108	3.2.2.77.	124
3.2.2.39.	108	3.2.2.78.	124
3.2.2.40.	109	3.2.2.79.	124
3.2.2.41.	109	3.2.2.80.	125
3.2.2.42.	110	3.2.2.81.	125
3.2.2.43.	83, 111	3.2.2.82.	126
3.2.2.44.	75, 111	3.2.2.83.	127
3.2.2.45.	112	3.2.3.	230
3.2.2.46.	113	3.2.3.1.	62, 65, 230-231, 234-235, 244
3.2.2.47.	75, 113, 178	3.2.3.2.	237-238
3.2.2.48.	113	3.2.3.3.	240
3.2.2.49.	89, 114	3.2.3.5.	235

APPENDIX

Index of Code References continued

3.2.3.6.	240	3.2.5.16.	307
3.2.3.7.	43, 231, 238, 244, 252	3.2.5.17.	317
3.2.3.8.	240	3.2.6.1.	321
3.2.3.9.	243	3.2.6.2.	324
3.2.3.10.	243	3.2.6.4.	326
3.2.3.11.	231, 244	3.2.6.5.	326
3.2.3.12.	249-250	3.2.6.6.	326
3.2.3.13.	245	3.2.6.7.	327
3.2.3.14.	247	3.2.6.8.	327
3.2.3.15.	192, 246-247	3.2.6.9.	327
3.2.3.16.	248-249	3.2.6.10.	327
3.2.4.1.	273, 275	3.2.7.8.	328
3.2.4.2.	274-275	3.2.7.9.	328
3.2.4.3.	274	3.2.8.	80, 185
3.2.4.4.	274	3.2.8.1.	185
3.2.4.5.	275	3.2.8.2.	79, 185, 187
3.2.4.7.	92, 186, 279-280	3.2.8.3.	185
3.2.4.8.	275-276	3.2.8.4.	185
3.2.4.9.	88, 186, 280	3.2.8.5.	185
3.2.4.10.	277	3.2.8.6.	186
3.2.4.11.	186, 277	3.2.8.7.	186
3.2.4.12.	277	3.2.8.8.	187
3.2.4.15.	279	3.2.8.9.	187
3.2.4.17.	276		
3.2.4.21.	279	3.3	
3.2.4.22.	327	3.3.1.3.	282
3.2.5.	65	3.3.1.4.	134, 286-287
3.2.5.1.	308	3.3.1.5.	283, 285
3.2.5.2.	308	3.3.1.6.	285
3.2.5.4.	305, 311	3.3.1.9.	287
3.2.5.5.	305-307, 311	3.3.1.22.	282
3.2.5.6.	305	3.3.2.2.	293
3.2.5.7.	311	3.3.2.3.	293
3.2.5.8.	316	3.3.2.4.	293
3.2.5.9.	317	3.3.2.5.	314
3.2.5.10.	316-317	3.3.2.9.	293
3.2.5.11.	317	3.3.3.5.	294
3.2.5.13.	312-314	3.3.4.2.	179, 293-294
3.2.5.14.	315	3.3.4.4.	293

APPENDIX

Index of Code References continued

3.3.5.4.	295
3.3.5.5.	295
3.3.5.6.	85, 295

3.4

3.4.2.1.	67, 288
3.4.2.3.	288
3.4.2.4.	285-286
3.4.2.5.	282, 289-290
3.4.3.	62
3.4.3.1.	289
3.4.3.3.	185
3.4.3.4.	289
3.4.3.5.	289
3.4.4.1.	288, 290
3.4.4.3.	250
3.4.4.4.	290
3.4.5.1.	290
3.4.6.	288

3.6

3.6.1.1.	297
3.6.2.	297
3.6.3.1.	297
3.6.3.3.	298
3.6.4.2.	135
3.6.5.4.	298

Appendix A

A-9.23.4.2.	32
A-9.10.3.1.A	153, 160, 166-167
A-9.10.3.1.B	166, 168

Appendix D

D-2.11.	37
D-2.3.	157
D-2.3.1.	158
D-2.3.2.	158
D-2.3.3.	161
D-2.3.4.	158-160
D-2.3.5.	159, 161
D-2.3.6.	158, 161
D-2.3.10.	163
D-2.3.11.	163
D-2.3.12.	161, 163
D-2.4.	163
D-2.11.2.	168
D-3.1.1.	204, 210, 325